



THIRD INTERNATIONAL CONFERENCE ON PERMAFROST
Edmonton, July 1978

ENGLISH TRANSLATIONS OF THE FORTY-NINE SOVIET PAPERS,
THE ONE FRENCH PAPER, AND THE THREE INVITED
SOVIET THEME PAPERS

PART II: ENGLISH TRANSLATIONS OF TWENTY-THREE OF THE
SOVIET PAPERS, THE FRENCH PAPER, AND THE
THREE INVITED SOVIET THEME PAPERS

TROISIÈME CONFÉRENCE INTERNATIONALE SUR LE PERGÉLISOL
Edmonton, juillet 1978

VERSIONS ANGLAISES DES QUARANTE-NEUF MÉMOIRES SOVIÉTIQUES,
DU MÉMOIRE FRANÇAIS, ET DES RÉTROSPECTIVES
PRÉSENTÉES PAR DES CHERCHEURS SOVIÉTIQUES

PARTIE II: VERSIONS ANGLAISES DE VINGT-TROIS MÉMOIRES SOVIÉTIQUES,
LE MÉMOIRE FRANÇAIS, ET DES TROIS RÉTROSPECTIVES
SOVIÉTIQUES

THIRD INTERNATIONAL CONFERENCE ON PERMAFROST

TROISIÈME CONFÉRENCE INTERNATIONALE SUR LE PERGÉLISOL

Edmonton, July/juillet 1978

ENGLISH TRANSLATIONS OF THE FORTY-NINE SOVIET PAPERS,
THE ONE FRENCH PAPER, AND THE THREE INVITED
SOVIET THEME PAPERS

VERSIONS ANGLAISES DES QUARANTE-NEUF MÉMOIRES SOVIÉTIQUES,
DU MÉMOIRE FRANÇAIS, ET DES TROIS RÉTROSPECTIVES
PRÉSENTÉES PAR DES CHERCHEURS SOVIÉTIQUES

PART II: ENGLISH TRANSLATIONS OF TWENTY-THREE OF
THE SOVIET PAPERS AND THE FRENCH PAPER
(published in Vol. 1 of Conference Proceedings)
AND THE THREE INVITED SOVIET THEME PAPERS
(published in Vol. 2 of the Proceedings)

PARTIE II: VERSIONS ANGLAISES DE VINGT-TROIS
MÉMOIRES SOVIÉTIQUES, ET LE MÉMOIRE FRANÇAIS
(publiées dans le Vol. 1 du Compte rendu
de la Conférence) ET DES TROIS RÉTROSPECTIVES
SOVIÉTIQUES (publiées dans le Vol. 2
du Compte rendu de la Conférence)

OTTAWA, March/mars 1980

NRCC 18119
Part II of two
Partie II de deux

Published by the
NATIONAL RESEARCH COUNCIL OF CANADA

Copies obtainable from: The Executive Secretary, Third International Conference on
Permafrost, c/o National Research Council of Canada, Ottawa, Ontario, K1A 0R6.

Price: \$35.00 (Parts I and II)

Part I

ISBN 0-660-10520-9
NRCC No. 18119
Cat. No. NR15-6/1978-3-1

Part II

ISBN 0-660-10521-7
NRCC No. 18119
Cat. No. NR15-6/1978-3-2

NOTE:

Volumes 1 and 2 of the Conference Proceedings have the following identification:

Vol. 1 ISBN 0-660-01735-0
NRCC No. 16529
Cat. No. NR15-6/1978-1

Vol. 2 ISBN 0-660-50401-4
NRCC No. 16529
Cat. No. NR15-6/1978-2

Publié par le
CONSEIL NATIONAL DE RECHERCHES DU CANADA

On peut obtenir des copies en s'adressant au Secrétaire administratif, Troisième
conférence internationale sur le pergélisol a/s du Conseil national de recherches
du Canada, Ottawa, Ontario, K1A 0R6.

Prix: \$35.00 (Parties I et II)

Partie I

ISBN 0-660-10520-9
CNRC N° 18119
N° de cat. NR15-6/1978-3-1

Partie II

ISBN 0-660-10521-7
CNRC N° 18119
N° de cat. NR15-6/1978-3-2

REMARQUE:

Les volumes 1 et 2 du Compte rendu de la Conférence sont identifiés comme suit:

Vol. 1 ISBN 0-660-01735-0
CNRC N° 16529
N° de cat. NR15-6/1978-1

Vol. 2 ISBN 0-660-50401-4
CNRC N° 16529
N° de cat. NR15-6/1978-2

PREFACE

The Third International Conference on Permafrost was held in Edmonton, Alberta, in July 1978. It was sponsored by the National Research Council of Canada through its Associate Committee on Geotechnical Research (Chairman - Dr. L.W. Gold, Associate Director, Division of Building Research, National Research Council of Canada). The Proceedings of the Conference, published in two volumes, included 139 submitted papers (Vol. 1) and 8 invited special theme papers (Vol. 2). This present publication (in two Parts) contains the 49 submitted Soviet papers, the 1 submitted French paper, and the 3 Soviet theme papers. The papers are in the same order as they appear in the Conference Proceedings.

This record is dedicated to the memory of Mr. Valery Poppe, a noted Russian interpreter and translator with the National Research Council of Canada. For many years he provided invaluable interpretation and translation services in the permafrost field which greatly assisted contacts between North American and Soviet scientists. He played an active role at the Third International Conference on Permafrost only weeks before his sudden and untimely death in September 1978. The NRC Associate Committee on Geotechnical Research and the Division of Building Research wish to take this opportunity to express their sincere appreciation of Mr. Poppe's many contributions to the work of the Division and the ACGR through the years.

Their thanks are here recorded also to the other translators for their services in the preparation of these books: P.J. Hyde and Associates, Walter Kent, Josef Nowosielski, Hazel Pidcock, Victor Popov, Robert Serré, Donald Sinclair, and Tania Thorpe. The technical editing was done by R.J.E. Brown, Division of Building Research with assistance from T.W.H. Baker of the same Division. Dr. Brown was Chairman of the Conference. The work of Lise Esselmont, NRC Translations, in organizing all the translations and producing the final typewritten manuscripts is also gratefully acknowledged.

Ottawa
March 1980

C.B. Crawford
Director, DBR/NRC

PRÉFACE

La Troisième conférence internationale sur le pergélisol a été tenue à Edmonton, Alberta, au mois de juillet, 1978. Elle a été parrainée par le Conseil national de recherches du Canada par l'entremise de son Comité associé de recherches géotechniques (Président - Dr. L.W. Gold, directeur adjoint, Division des recherches sur le bâtiment, Conseil national de recherches du Canada). Le compte rendu de la Conférence, publié en deux volumes, comprend 139 mémoires (vol. 1) et 8 rétrospectives spéciales (vol. 2). La présente publication (en deux parties) comporte 49 mémoires soviétiques, le mémoire français et les trois rétrospectives soviétiques. Les mémoires apparaissent dans le même ordre que celui du compte rendu de la Conférence.

Ce document est dédié à la mémoire de M. Valery Poppe, interprète et traducteur russe distingué qui a travaillé au sein du Conseil national de recherches du Canada. Pendant plusieurs années, il a fourni un service d'interprétation et de traduction inestimable dans le domaine du pergélisol, qui a grandement aidé les rapports entre les scientifiques nord-américains et soviétiques. Il joua un rôle actif lors de la Troisième conférence internationale sur le pergélisol quelques semaines seulement avant sa mort soudaine et prématurée survenue au mois de septembre, 1978. Le Comité associé de recherches géotechniques du CNR et la Division des recherches sur le bâtiment profite de l'occasion pour exprimer leur gratitude pour les nombreuses contributions de M. Poppe au travail de la Division et du CARG au cours des années.

Il remercie également les autres traducteurs pour leurs services lors de la préparation de ces livres: P.J. Hyde et associés, Walter Kent, Josef Nowosielski, Hazel Pidcock, Victor Popov, Robert Serré, Donald Sinclair, et Tania Thorpe. La révision technique a été faite par R.J.E. Brown, de la Division des recherches sur le bâtiment avec l'aide de T.W.H. Baker de la même Division. Le Dr. Brown était le président de la Conférence. Le travail de Lise Esselmont, des Services de traduction du CNR, pour l'organisation de toutes les traductions et la production du document final est aussi grandement apprécié.

Ottawa
mars 1980

C.B. Crawford
Directeur, DRB/CNR

TABLE OF CONTENTS

(Parts I and II)

PART I

	Page
Balobaev, V.T. Reconstruction of Palaeoclimate from Present Day Geothermal Data	1
Gavrilova, M.K. Classification of the Relationship Between Climate and Permafrost-Climatic Regions	13
Moskalenko, N.G. et al. The Effect of Developing a Territory on the Heat Balance and the Thermal and Moisture Regime of the Ground in the Northern Part of Western Siberia	29
Pavlov, A.V. Thermal Physics of Permafrost Terrain	45
Kudryavtsev, V.A. and Melamed, V.G. Geophysical Aspects of the Development of Permafrost	63
Kvlividze, V.I. et al. An NMR Study of the Phase Transition of Water in Models and in Frozen Clays	81
Savel'ev, B.A. Investigation of the Structure and Properties of Bound Water	97
Shvetsov, P.F. Conditions and Geothermal Consequences of the Moisture Exchange Between the Lithosphere and the Atmosphere in Permafrost Regions	109
Zhestkova, T.N. Results of Experimental Studies of the Freezing Process in Very Fine-Grained Soils	119
Chizhov, A.B. The Role of Highly Mineralized Groundwater in the Cooling of the Lithosphere at Depth	137
Ershov, E.D. et al. Experimental Investigation of Heat and Moisture Transfer During Sublimation - Desublimation of Water in Fine-Grained Soils	143
Ershov, E.D. et al. Water Migration, Formation of Texture and Ice Segregation in Freezing and Thawing Clayey Soils	159
Fotiev, S.M. Effect of Long-Term Cryometamorphism of Earth Materials on the Formation of Groundwater	177
Romanovskii, N.N. et al. Long Term Dynamics of Groundwater Icings	195
Baulin, V.V. et al. The Role of Tectonics in the Formation of Permafrost on Low Plains	209

Gasarov, Sh.Sh. Cryolithogenesis as an Independent Hydrothermal Type of Sedimentary Process	225
Gravis, G.F. Cyclic Nature of Thermokarst on the Maritime Plain in the Upper Pleistocene and Holocene	245
Grechishchev, S.E. Some Aspects of the Mechanics of Frost Fracturing of Soils in the Permafrost Zone	259
Konishchev, V.N. Mineral Stability in the Zone of Cryolithogenesis	279
Romanovskii, N.N. Principles of Classification of Polygonal-Vein Structures	297
Arc, F.E. Offshore Permafrost in the Asiatic Arctic	311
Baranov, I. Ya. Structure of the Northern Circumpolar Permafrost Region	327
Dubikov, G.I. More Precise Position of the Southern Permafrost Boundary Between the Urals and the Ob River	347
Gorbunov, A.P. Permafrost in the Mountains of Central Asia	357
Kudryavtsev, V.A. et al. Zonal and Regional Patterns of Formation of the Permafrost Region in the U.S.S.R.	371
Popov, A.I. et al. Cryolithological Map of the U.S.S.R. (Principles of Compilation)	391

20
27
53

PART II

Vtyurin, B.I. Principles of Cryolithological Regionalization of the Permafrost Zone	1
Grave, N.A. and Sukhodrovskii, V.L. Terrain-Forming Processes in the Permafrost Region and the Principles of Their Prevention and Limitation in Territories under Development	11
Anisimova, N.P. Hydrogeochemical Investigations in Permafrost Studies	25
Avetikyan, Yu. A. Use of AC Current Surveys in Permafrost Studies	43

	Page
Kudryavtsev, V.A. and Maksimova, L.N. Forecast of Changes in Geocryological Conditions during Economic Development of the Permafrost Region	57
Kudryavtsev, V.A. and Kondrat'eva, K.A. Geocryological Survey Methods	71
Mel'nikov, V.I. and Gennadinik, B.I. Electrical State of a Permafrost Cross Section	85
Garagulya, L.S. et al. Thermal Interaction of Pipelines with the Ground	103
Aguirre-Puente, J. Present State of Research on the Freezing of Rocks and Construction Materials	117
Dokuchaev, V.V. et al. Ice Rich Soils as Bases for Structures	133
Frolov, A.D. Problems and Possibilities of Studying the Processes of Dynamic Relaxation in Frozen Earth Materials	149
Maksimyak, R.V. et al. On the Role of the Components of Frozen Clay Soils in the Development of Strength at Different Temperatures	169
Vyalov, S.S. Kinetic Theory of Deformation of Frozen Soils	185
Baulin, V.V. et al. Permafrost Investigations in Pipeline Construction	199
Biyanov, G.F. and Makarov, V.I. Characteristics of the Construction of Frozen Dams in Western Yakutiya	213
Buchko, N.A. et al. Seasonally Operating Units and Their Use in Northern Construction	227
Makarov, V.I. et al. Construction of Multi-Storey Buildings on Cold Piles in the City of Mirnyi	241
Peretrukhin, N.A. Strength and Stability of Railway Subgrades in Permafrost Regions	255
Popov, B.I. et al. Construction of Earth Embankments for Highways in Western Siberia	269
Porkhaev, G.V. et al. Construction by the Method of Stabilizing Perennially Frozen Foundation Soils	283
Vyalov, S.S. Long-Term Settlement of Foundations on Permafrost	297
Maksimov, V.M. Hydrodynamic and Hydrochemical Assessment of Explosions Used in Testing Low-Output Wells in Permafrost Regions	313

	Page
El'chaninov, E.A. et al. The Stability of Underground Workings in Permafrost	321
Emel'yanov, V.I. and Perl'shtein, G.Z. Water Thawing of Frozen Ground for Open Pit and Underground Mining in the Northeast of the U.S.S.R.	339
Mel'nikov, P.I. Permafrost - Hydrogeological Zoning of Eastern Siberia	355
Vyalov, S.S. Interaction between Permafrost and Buildings	379
Tsytovich, N.A. et al. Design, Construction and Operation of Earth Dams in Arctic Regions and under Permafrost Conditions	407

PRINCIPLES OF CRYOLITHOLOGICAL REGIONALIZATION
OF THE PERMAFROST ZONE

B.I. Vtyurin

Pacific Institute of Geography, Vladivostok, U.S.S.R.

Cryolithological regionalization, like all other types of regionalization, consists in the unification of territories showing relative similarities in several important characteristics. In cryolithology these are: structure and texture of permafrost; ice content of permafrost; quantity of ground ice as a whole, and of individual types in particular, etc.

Hitherto, the principles for special cryolithological regionalization had not been formulated. Some of the important cryolithological characteristics indicated above were considered earlier in a general, complex, geocryological regionalization (Baranov, 1965), permafrost-geological regionalization (Popov, 1958), and permafrost regionalization according to formation characteristics (Shvetsov, 1956), etc. These were utilized more fully by the author, but each in isolation, when compiling the schematic review maps of the permafrost regions of the U.S.S.R.: distribution of permafrost with differing structures, textures, evident ice content, and quantities of evident ground ice, etc. (Vtyurin, 1975).

As we know (Armand, 1975), this kind of mapping can quite correctly be called a typological branch of regionalization. However, in that case, it has a single component and is completed in a single stage. Therefore, in order to change to a complex permafrost regionalization consisting of many components, and consequently many stages, criteria must be

selected for division into stages. Any selection of a single criterion is subjective. Therefore, in order that the selection might not be random, it was essential to establish the purpose of the regionalization.

Cryological, typological regionalization can be for either scientific, or applied economic aims. The former must obviously be based on the genetic characteristics of the permafrost: the latter, on quantitative estimates and types of ground ice which exert considerable influence on the engineering properties of the permafrost.

At the current level of permafrost studies, small-scale cryolithological mapping and regionalization can only be used in pursuit of scientific aims: for revealing geographic patterns in the processes of ice formation in earth materials, paleocryological and paleogeographical conditions of formation of permafrost during various epochs of the Quaternary, etc. Therefore, it must be based on a genetic approach: a record of distribution patterns of various types, forms and variations of permafrost both areally and vertically.

Essentially, cryolithological regionalization for scientific ends is a prerequisite for practical regionalization, since it creates a regional basis for the interpolations and extrapolations which are unavoidable when using the quantitative criteria of this type of regionalization.

Any kind of regionalization can only be carried out on the basis of relative classifications of the object. Accordingly, for cryolithological regionalization, there must be classification of the permafrost; this is compiled from a record of those characteristics deemed to be the most important. The author presents a complex classification he has formulated for permafrost, according to cryolithological characteristics (Table). According to structure, i.e., according to the bedding of various types of cryogenic structures, there are two classes of permafrost: mono- and polygenetic. According to formation process (epi- or syngenetic) there are 4 types of permafrost. According to participation in the texture of the ground ice forming the bed there are 12 types of permafrost. The dominant lithogenetic types of earth materials have been characterized in the figure;

TABLE

Classification of permafrost according to structure and texture.

Class (according to structure and bedding)	Type (by formation process)	Form (according to degree of participation of the underground ice bed)	Predominant lithogenic type of earth materials	Distribution (throughout the general geocryological zones; according to Baranov 1956)
Monogenetic	Epigenetic	1. Simple, without ice bed	Course-granular, not penetrated by water prior to freezing, differing genesis.	All zones
		2. Complex, stratified bedding or segregated and injected ice, shallow occurrence.	Sections differ, penetrated by water (with water-bearing horizons) marine, glacial-marine, less frequently - alluvial	Temperate southern
		3. Complex, with fine epigenetic ice veins	Finely-dispersed, alluvial, lake-swamp, etc. peatlands	Temperate
		4. Very complex, with stratified ice and wedge ice	Combination of conditions characteristics of forms 2 and 3	Temperate
	Syngenetic	5. Simple, without ice bed	Mainly peatlands	Southern
	Syn-epigenetic with 2 horizons	6. Simple, without ice bed	Coarse-grained, alluvial, coastal, fluvio-glacial, etc.	Northern, Arctic
		7. Complex, stratified ice in the epigenetic horizon	Combination of conditions characteristic of form 6 in the syngenetic horizon, and of type 2 in the epigenetic horizon	Northern, Arctic
		8. Complex, with epi- and syngenetic veins in the syngenetic horizon.	Finely dispersed, alluvial, lake-swamp, slope, etc.	Northern, Arctic
		9. Very complex, with ice veins in the syngenetic horizon, striated in the epigenetic horizon	Combination of conditions typical of form 7 in the syngenetic horizon and of form 2 in the epigenetic horizon.	Northern, Arctic

TABLE
(cont'd)

Polygenetic	Multi-horizoned (mainly 4), syn-epi-syn-epigenetic	10. Simple, without ice bed	Coarsely-grained, alluvial, coastal, glacial, etc.	Northern, Arctic
		11. Complex, with ice veins in the syngenetic horizon.	Finely-dispersed, alluvial, slope, etc.	Northern, Arctic
		12. Very complex, with ice veins in the syngenetic horizons, and stratified in the epigenetic horizons	Combination of conditions, typical of forms 2 and 3 in the epigenetic horizons, and of form 7 in the syngenetic horizons.	Northern, Arctic

these acquire one type of texture or another during freezing and a preferred distribution throughout the general permafrost zone, as depicted on Baranov's geocryological map of the U.S.S.R. (I.Ya. Baranov, 1956).

In our opinion, the classification is sufficiently detailed and can be used as the basis for small-scale mapping and regionalization of permafrost. Furthermore, it allows further elaboration with the introduction of gradations of the classes recording cryogenic structures, thickness of the upper syngenetic horizon, etc.

In the classification presented, the approximate taxonomic system of units for individual regionalization (according to Armand, 1975), which correspond with the taxonomy of typological regionalization, could be: province, region, district.* For medium and large scale regionalization of the limited areas of dry land, the selection of taxonomic units must be different. There must also be a different and more detailed classification for permafrost. However, the basic approach to regionalization must, in our opinion, be adhered to, even here.

* provintsiya, oblast', raion (Transl.).

SCHEMATIC CRYOLITHOLOGICAL REGIONALIZATION OF THE NORTH-EAST U.S.S.R.

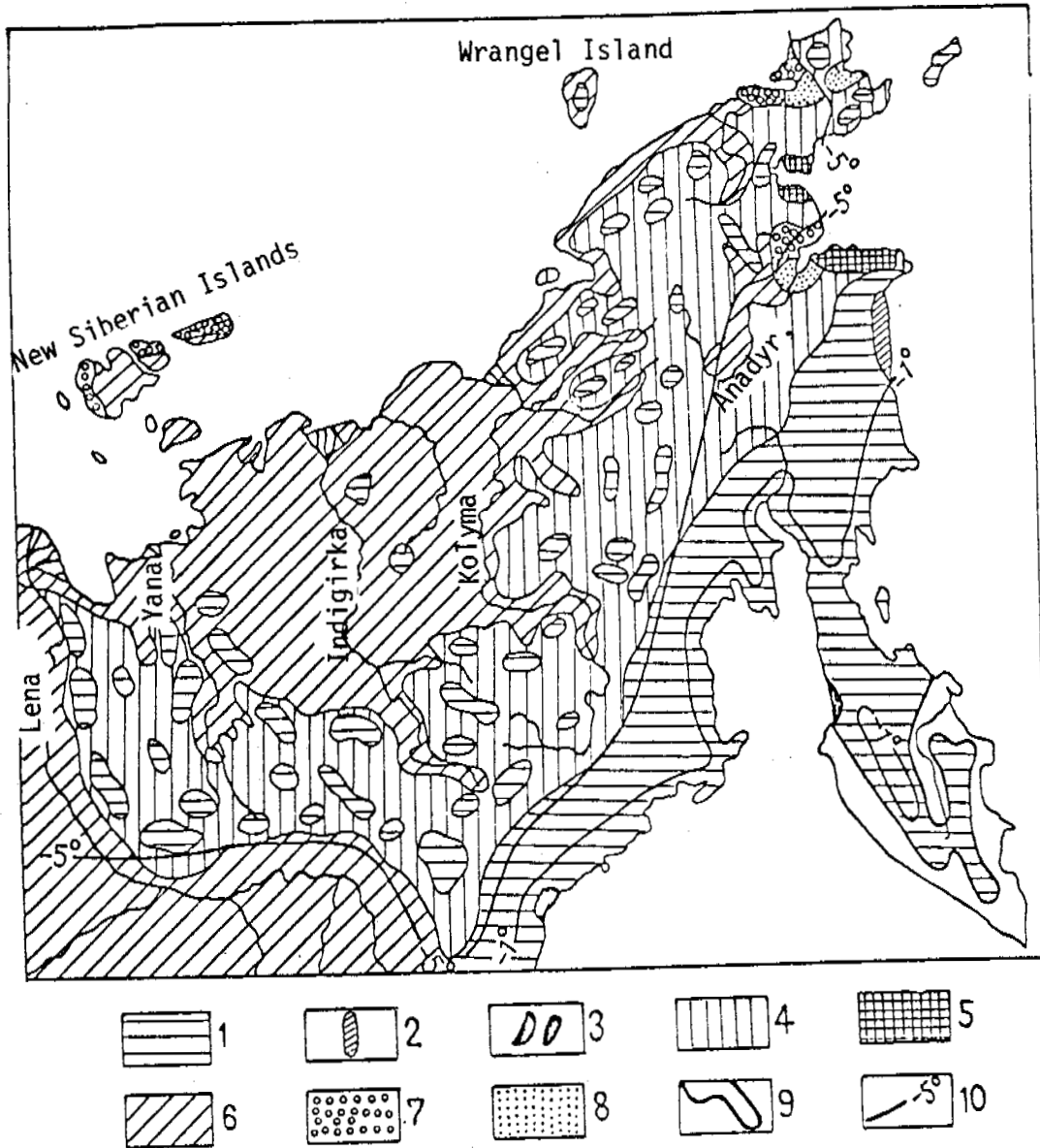

Province of multigenetic permafrost.

Region of epigenetic permafrost: 1 - districts with simple form of cryogenic structure, without an ice bed; 2 - district with complex form of cryogenic texture, with sheet segregated and injected ice.

Region of syngenetic permafrost: 3 - districts with simple form of cryogenic texture (tentatively isolated).

Province of polygenetic permafrost.

Region of epi-syngenetic permafrost with two horizons: 4 - districts with simple form of cryogenic structure; 6 - districts with complex forms of cryogenic structure, with ice wedges in the syngenetic horizon; 7 - districts with very complex forms of cryogenic texture, with sheet ice in the epigenetic horizon, and with ice veins in the syngenetic horizon.

Region of multi-horizons, syn-epi-syn-epigenetic permafrost: 8 - districts with undetermined form of cryogenic structure (tentatively isolated).

9 - southern boundary of permafrost distribution (according to Baranov, 1956); 10 - geoisotherm (according to Baranov, 1956).

It would be very tempting to carry out regionalization and to compile a map of the Earth's whole lithosphere immediately. However, there is so little information available for this purpose that we must refrain from attempting this, even within the U.S.S.R., and we must use the Northeast U.S.S.R. alone as our example (Figure). This area, with which the author is very familiar, possesses a great variety of genetic types of permafrost. This allows almost the entire range of the proposed classification to be used.

In accordance with the taxonomy being used, the territory under observation can clearly be divided into two provinces: 1) monogenetic permafrost, extending southwards from the geotherms -4° , -5°C , and 2) polygenetic permafrost, extending northwards from the above-mentioned isotherms. It should be noted that the southern boundary of polygenetic permafrost distribution is more or less well defined, which cannot be said for the northern boundary of the monogenetic (epigenetic type only) permafrost. The latter occur in the form of isolated regions in mountainous areas throughout the whole cryolithosphere. They are restricted to disintegrating outcrops of bedrock, and to steep, denuded slopes from which virtually all unconsolidated materials have been removed.

Within the province of monogenetic permafrost, regions with the syngenetic type of cryogenic texture of the simple form are isolated. These can only form along the southern fringe of the permafrost, in areas of present day tectonic settling - mainly in peatlands. Such areas can be assumed to be present in West Siberia, the Far East and, on the map presented, on the west coast of Kamchatka and on the Okhotsk coast. According to the data of some researchers who have studied the shores of the Far Eastern seas (Ionin et al., 1971; Zenkovich et al., 1971), the coastline of West Kamchatka bears traces of recent submergence which, in some areas, may possibly be continuing even now. Since permafrost with temperatures of 0° to -1°C cannot be very thick, its syngenetic growth from above during submergence of the surface inevitably leads to thawing from below. As a result, thin layers of syngenetically formed permafrost (and therefore with a cryogenic texture) can be preserved in the section. In actual fact, however, these layers of permafrost have not been ascertained by anyone as yet.

Within the province of polygenetic permafrosts, regions with a multiplicity of horizons (at least four) have been tentatively isolated. Furthermore, these are the tectonically unstable coastal areas within which, during the Quarternary, there were several glacial advances (Nizhne-Anadyr', Kolyuchinskaya and Lavrent'evskaya Depressions). Such permafrost has not yet been recorded in the Northeast U.S.S.R. but, by analogy with several other regions, (for example, Western Siberia and the lower reaches of the Yenisei), we consider the assumption of its presence to be justified. Naturally, on the map presented, we have not established the actual form of cryogenic texture of the permafrost. However, considering that they are always formed within northern and arctic geocryological zones, where the temperatures of the permafrost is below -5°C , it can be assumed that its cryogenic structure will be mainly complex, with wedge ice in the syngenetic horizons. It was precisely this type of texture that we observed in the multi-horized permafrost in the lower reaches of the Yenisei (Vtyurin, 1966).

Complex permafrost with two horizons have the largest, areal distribution in the Northeast U.S.S.R. These are mainly permafrost regions with widely developed wedge ice forming the ice beds in the upper syngenetic horizon. Less frequently, regions are encountered in which cryogenic texture is very complex. This occurs when the beds of ground ice developed not only syngenetically, but also in the upper part of the epigenetic horizon (sheets of primordial ground ice of segregated or injected origin). They have been recorded on the coastal areas of the Gulf of Anadyr', on the shores of the Sea of Okhotsk (Vtyurin, 1964; Gasanov, 1969), and on the New Siberian Islands (Vollosovich, 1962; Ivanov, Yashin, 1959).

Therefore, within the area being examined, regions with the mono-epigenetic type of permafrost of the complex and very complex forms (No 3 and No 4, in the classification) are not isolated, nor are regions with polygenetic, multi-horized permafrosts of all types (nos 10-12 in the classification). Of course, this does not mean that these do not exist. In principle, these are included. For example, during future research of the Koryak Range, the Kamchatka Peninsula and other regions, epigenetic permafrost with wedge ice (or rather, relic ice - which does not change the situation) will probably be found. The study of coastal areas with unstable

tectonic regimes will probably permit future isolation of various types of multi-horized layers of polygenetic permafrost.

If the areal distribution patterns of permafrost possessing differing textures is examined throughout all the geocryologic zones, then it is not difficult to observe that the polygenetic permafrost zone extends over the northern and arctic zones, and that the monogenetic permafrost zone is mainly within the southern and temperature zone. The exceptions, as we have already pointed out, are the regions with the epigenetic type of permafrost of the simple form; these are azonal and are found in all geocryological zones.

In conclusion, we would like to emphasize once more the systematic nature of the work completed. For this reason, the appended map of the cryolithological regionalization of the Northeast U.S.S.R. should be considered essentially as the principle schema.

It is expedient that further elaboration of the regionalization should be directed towards the isolation of taxonomic units associated with recording differences in cryogenic structures (streaky, massive) and thicknesses of the upper syngenetic horizon of polygenetic permafrosts.

REFERENCES

- ARMAND, D.L. Nauka o landshafte. (Landscape Science). M., "Mysl'", 286 pages, 1975.
- BARANOV, I.Ya. Geokriologicheskaya karta SSSR. (Geocryological Map of the U.S.S.R.) M., 1956.
- BARANOV, I.Ya. Printsipy geokriologicheskogo (merzlotnogo) raionorovaniya oblasti mnogoletnemerzlykh gornyykh porod. (Principles of geocryological regionalization of the permafrost region). "Nauka", 150 pages, 1965.
- VOLLOSOVICH, K.A. O geologicheskikh rabotakh na Novosibirskikh ostrovykh. (Geological operations on the New Siberian Islands). Izv. Imp. Nauk. SPB, Vol. XVI, No. 5, pp. 7-10, 1902.
- VTYURIN, B.I. Kriogennoe stroenie chetvertichnykh otlozhenii. (Cryogenic structure of Quarternary deposits). M., "Nauka", 151 pages, 1964.

- VTYURIN, B.I. Kriogennoe stroenie chetvertichnykh otlozhenii v nizov'yakh Eniseya. (Cryogenic structure of Quaternary deposits in the lower reaches of the Yenisei). In the book: Materialy k nauchn. tekhn. konferentsii po inzhenernym izyskaniyam. (Papers for the Scientific and Technical Conference on Engineering Surveys). M., pp. 177-180, 1966.
- VTYURIN, B.I. Podzemnye l'dy SSSR. (Ground ice in the U.S.S.R.). M., "Nauka", 212 pages, 1975.
- GASANOV, Sh.Sh. Stroenie i istoriya formirovaniya merzlykh porod Vostochnoi Chukotki. (Structure and history of the formation of permafrost in Eastern Chukotka). M., "Nauka", 168 pages, 1969.
- ZENKOVICH, V.P., LEONT'EV, O.K., NIKIFOROV, L.G. and LUK'YANOVA, S.A. K geomorfologii zapadnogo poberezh'ya Kamchatki. (Geomorphology of the west coast of Kamchatka). In the book: Geomorfologiya i litologiya beregovoi zony morei i drugikh krupnykh vodoemov. (Geomorphology and lithology of the shores of seas and other large bodies of water). M., "Nauka", pp. 3-8, 1971.
- IVANOV, O.A. and YASHIN, D.S. Novye dannye o geologicheskom stroenii ostrova N. Sibir'. (New data on the geological structure of Novaya Sibir' Island). - Trudy NIIGA (Proceedings of the Scientific Research Institute of Arctic Geology). Vol. 96, No. 8, pp. 61-78, 1959.
- IONIN, A.S., KAPLIN, P.A. and LEONT'EV, O.K. et al., Osobennosti formirovaniya rel'efa i sovremennykh osadkov v pribrezhnoi zone dal'nevostochnykh morei SSSR. (Peculiarities of formation of the topography and present-day silts in the coastal regions of the Far Eastern Seas of the U.S.S.R.) M., "Nauka", 181 pages, 1971.
- POPOV, A.I. Merzlotno-geologicheskoe raionirovanie oblasti vечноi merzloty v SSSR. (Permafrost-geological regionalization of the permafrost zone of the U.S.S.R.) - Inform. sb. o rabotakh geogr. fak. MGU po MGT. (Inform. on Work of the Dept. of Geo. at Moscow State Univ. on MGU and MGT) No. 1, Izd-vo, MGU, pp. 239-264, 1958.
- SHVETSOV, P.F. O printsipakh mnogoletnei kriolitozony. (Principles of the Permafrost zone). In the book: Mat-ly k osnovam ucheniya o merzlykh zemnoi kory, Vyp. 3. (Basic material for the study of the permafrost zones of the Earth's crust). No. 3., M., Izd-vo AN SSSR, pp. 18-40, 1956.

TERRAIN-FORMING PROCESSES IN THE PERMAFROST REGION AND THE PRINCIPLES OF
THEIR PREVENTION AND LIMITATION IN TERRITORIES UNDER DEVELOPMENT

N.A. Grave and V.L. Sukhodrovskii
Permafrost Institute, Yakutsk

Economic development of a region with ice rich permafrost, which is accompanied by a disturbance of vegetation and top layer of soil, eventually leads to a change in the heat exchange between the ground and the air layer at the surface. This activates or generates new processes of cryomorphogenesis in the region under development and in adjacent areas, which in turn changes the landscape including local terrain. As a result, buildings and other structures often suffer severe damage.

The active cryomorphogenetic processes in newly developed areas include solifluction, thermal erosion, heaving and thermokarst. The first two are part of thermal denudation, while the last two are cryogenic processes proper. All these processes may interact, although one of them will be the predominant one, depending on the slope of the ground surface or the extent of its drainage. The ice (water) content of the ground, its lithological and grain size composition, and the depth of seasonal freezing and thawing are the elements of the substrate in which these processes are developing. They determine the intensity of cryomorphogenesis and manifest themselves in the degree of modification of primary terrain.

However, active development of terrain forming processes caused by economic activity cannot go on forever. Nature constantly tends to ecological equilibrium (Shvarts, 1976). Hence these processes attenuate with time and the newly formed terrain achieves a state of equilibrium with the newly established heat exchange between the ground and the air layer at the

surface. This is the beginning of a new stage of terrain stabilization which lasts until the heat balance is once again disturbed.

The intensity of natural terrain forming processes not related to economic development of a given area is usually quite low, which indicates that these processes are capable of self regulation. I.P. Gerasimov (1970) considered the soil and vegetation cover to be the main "regulator" of terrain forming processes which "possesses specific antierosive properties controlling the intensity of natural denudation, i.e., it makes denudation proportional to tectonic movements" (p. 12). The absolute age of the present-day soils, which ranges from a few hundred to 1000 - 3000 years, can be taken as proof of such a role of the soil-vegetation cover. This rate of denudation corresponds to an annual increase in the soil thickness of 1 to 100 mm, i.e., an increase which lies within the limits of intensity of tectonic movements. Further evidence of the regulating role of the soil-vegetation cover is provided by long term investigations, according to which a disturbance of this cover on the slopes intensifies denudation by one or two orders of magnitude.

The cryomorphogenetic processes which develop under natural conditions were described in a number of studies (Solov'ev, 1962; Kaplina, 1965; Zhigarev, 1967; Kosov, Konstantinova, 1969; Sukhodrovskii, 1972, 1976; etc.).

There are as yet no adequate descriptions of similar processes resulting from economic development of a given area. Briefly these processes are as follows.

Solifluction is a common phenomenon in the permafrost region on moist fine grained soils. Under natural conditions, its average rate is 1 to 4 cm per year. Disturbance of the soil and vegetation cover on ice rich ground increases the depth of seasonal thawing and this in turn increases the rate of solifluction making it possible to observe it visually.

In due course, some sections of the slopes level off, thawed moist soil begins to dry and its mobility is reduced. The surface terrain becomes

stable and a new soil-vegetation cover is formed. Once rapid solifluction stops, which occurs in stages, vegetation appears soon after that (in the first few years), even on the slopes in the tundra (Konstantinova, Tyrtikov, 1974). A number of studies in Siberia and Alaska (Bol'shakov, 1966; Sukhodrovskii, 1972; Zhigarev, 1975; Smith, Berg, 1973) indicates that destructive processes normally attenuate over a period of 5 to 10 years, while the stage of their active development lasts not more than 2 - 3 years.

It is possible to single out three stages in the development of slopes once their soil and vegetation cover has been disturbed. The first stage is characterized by the most active development of rapid solifluction, which usually manifests itself in slumping leading to formation of rills and thermal denudation surfaces with accumulation trains and occasional lobes. There is a possibility of cave-ins of drying soil on steep slopes. The second stage is characterized by a gradual attenuation of solifluction and soil creep as the slopes develop a new plant cover. The third stage, which starts once the slopes are completely covered with new vegetation, is characterized mainly by slow solifluction sometimes leading to formation of solifluction terraces. If local conditions are such that the slopes do not acquire a new plant cover, the third stage will be absent altogether.

Thermal erosion results in formation of gorges and occurs in places where the geomorphological conditions favour a concentrated surface runoff on ice rich soils. Normal erosion in this case is accompanied by melting of ground ice. Thermal erosion is facilitated by the disturbance of the soil and vegetation cover and is, therefore, often generated by the tracks of vehicles which follow the direction of the slope. Another reason for its development may be formation of hollows resulting from rapid solifluction. This is most likely to occur in funnel-shaped depressions collecting water or on depressed cirque-like sections of the slopes.

The main reason for the intensification of gorge formation in newly developed regions of the tundra is a sudden increase in surface runoff resulting from accumulation of snow near buildings and other structures. As the gorges increase in size, they too begin to accumulate more and more snow. Subsequent melting of this snow intensifies erosion still further. Another

reason for increased runoff is water discarded from industrial and residential buildings.

Formation of gorges in ice rich soil leads to active development of solifluction on the slopes. The creeks and streams do not have sufficient time to remove the sediments deposited at the foot of the slopes. As a result, the slopes retreat relatively rapidly but the steep dip of the bottom of the gorges is retained (Sukhodrovskii, 1972; Konstantinova, Tyrtikov, 1974).

There are three stages of development of thermal erosion which correspond to specific forms of terrain. In the first stage, rills are formed, i.e., shallow erosional incisions. On sections with a disturbed plant cover, these incisions usually constitute the beginning of a new gorge. In the second stage, the rills become deeper and wider and are transformed to gorges proper, which may take anywhere from one to several years. In the third stage, the gorges are transformed to shallow valleys with smoothed-out sides. This process marks the end of down-cutting and retrogressive erosion due to levelling of the longitudinal profile of the valley bottom.

There is still no information on how long it takes for the longitudinal profile to level off, in relation to the runoff, the surface gradient, the composition of the soil and its ice content. The data on changes in the growth rate of gorges in newly developed areas seem to indicate that formation of a new longitudinal equilibrium profile takes anywhere from ten to twenty years or longer. The stage of valley formation is much longer than the two preceding stages and may be repeatedly interrupted by the downcutting of new streams resulting from changing conditions of runoff.

Heaving caused by human activity, as well as natural heaving, results from freezing of earth materials accompanied by water migration with subsequent formation of ground ice. The extent of heaving depends on its rate, the water content of the soil before and during freezing, and on the physical and mechanical properties (Nevecherya, 1973). Heaving may be seasonal or perennial.

The most important result of seasonal heaving related to formation of segregated ice are the so-called frost boils, which usually occur on construction sites and roads, if within their limits the layer of seasonal thawing accumulates and stores considerable amounts of water. The frost boils are formed in winter. Subsequent thawing of ice rich soils in the spring and summer results in their settlement, rarefaction and formation of mudflows.

Perennial heaving may occur locally or over extensive areas. It is usually due to freezing of taliks, which may result from construction of drainage trenches and, in particular, from emptying of lakes. Extensive heaving resulting from ice segregation often leads to formation of frost mounds up to several meters in height. The latter may contain both injected and segregated ice. The growth rate of such mounds reaches several decimeters per year.

Formation of perennial frost mounds can be divided into three stages as well. The first two stages refer to youthful and mature forms of terrain respectively. The third stage should evidently be related to the destruction of frost mounds due to thermal denudation.

Thermokarst is a process opposite to heaving. It manifests itself in melting of ground ice and in formation of negative relief forms, such as depressions and lake basins. Thermokarst as such is practically absent on inclined surfaces with a runoff. Instead there is thermal denudation including thermal erosion.

Local melting of ground ice is most likely on level surfaces where thermokarst features may be formed due to an increase in the ground temperature. Such an increase may result from a change in thermal insulation of the ground surface due to human activity, which may increase the depth of seasonal thaw of ice rich soils. This happens, for example, if the soil and vegetation cover is disturbed by vehicles. In this case, water will accumulate in the ruts leading to formation of sinkholes, which may reach 1 - 1.5 m in depth. However, formation of thermokarst sinkholes often stops at a very early stage of their development, since water in them evaporates in

the summer. Such sinkholes stabilize fairly rapidly. The same may happen if thawing soil has a low ice content.

Large thermokarst features, such as lake basins, can be formed only in places of occurrence of thick ground ice. In our opinion, another reason for active development of thermokarst is considerable transformation of primary terrain by man, which may lead to large accumulations of water on ice rich ground. Something like this may happen as a result of large scale earthworks, such as construction of road beds and other embankments impeding natural runoff. To our knowledge, attempts to activate thermokarst by disturbing the soil and vegetation cover so as to create a water body have not been successful so far. They merely led to formation of thermokarst depressions which became stabilized only a few years later. Even if these depressions were filled with water in the spring or during rains, the latter evaporated completely or partially.

Consequently economic activity is usually the reason for formation of relatively small thermokarst depressions. Conversion of such depressions to large thermokarst lakes is possible only by creating artificial conditions for a positive water balance in places of occurrence of thick ground ice.

Thus it is possible to single out two stages in the development of thermokarst terrain: formation of depressions and their transformation to lake basins, although the latter process may stop soon after its initiation. There is yet another process which may terminate in the development of the third stage, i.e., formation of alasses. But this is a very lengthy process and is likely to occur only on ancient accumulation surfaces where thermokarst interacts with thermal erosion and thermal denudation.

We have seen that heaving and thermokarst, which normally occur on level accumulation surfaces, depend on the moisture content of the ground and the presence of water on the surface respectively, which in turn depends on the runoff. Consequently, the main regulator of these processes is the terrain itself. In this, heaving and thermokarst differ from solifluction and thermal erosion whose development is controlled by the soil and vegetation cover.

To devise engineering methods of stopping or limiting the destructive processes resulting from economic activities in a given area, it is essential to know the intensity and the consequences of these processes. Unfortunately, there is still very little practical experience in forecasting changes in the engineering and geocryological conditions. At the same time, much has been done to collect and summarize the factual data on the environmental conditions in newly developed permafrost regions, both in the U.S.S.R. and in the American North, i.e., data which are essential for qualitative forecasting. The theoretical basis of geocryological forecasting and the methods of estimating possible changes in environmental conditions have been developed also.

Large scale research programmes were carried out in Alaska and Northern Canada and provided the information required to predict all possible environmental disturbances resulting from human activities and including destructive processes in permafrost (formation of gorges, slumping, solifluction, thermokarst) which occur in the course of construction of highways, industrial buildings, etc.

A wide range of ecological studies was carried out in Alaska (the Tundra Biome programme). The permafrost terrain features and the processes responsible for their formation were described by Everett (1975). In 1976-79 CRREL intends to carry out a special programme of geocryological investigations along the Yukon River - Prudhoe Bay highway and pipeline, which will centre on forecasting the destructive processes in the course of construction (Environmental Engineering Investigations, 1976).

The ALUR programme initiated in Canada in 1971 by the Department of Indian and Northern Affairs includes a wide range of studies with the aim of obtaining detailed information on the natural environment in Canada north of 60°N. This information will be used to forecast the harmful consequences of economic development (Grave, 1977). Landuse and terrain sensitivity maps are being compiled from engineering-geological, geocryological, geobotanical and other maps on the scale 1 : 250,000 prepared by private companies. The Geological Survey of Canada has compiled a terrain sensitivity map of the Mackenzie Valley and the northern part of the Yukon Territory on the scale 1 : 1,000,000 (Terrain Sensitivity, 1975).

The map shows regions with characteristic geology and geomorphology. The terrain sensitivity indices, the extent of disturbances and the types of reaction to these disturbances are given for each region. Finally, there is a list of processes which should be considered in preparing the forecasts.

The terrain sensitivity depends on the reaction of the terrain to a disturbance, which in turn depends on the amount of ice in the ground and the depth of its occurrence, the gradient of the surface, the ground composition, and the soil-vegetation cover. The sensitivity is expressed in classes, increasing with respect to intensity from 1 to 7. Geocryological forecasting is already in use in Alaska and Northern Canada in the construction of highways and pipelines.

In the U.S.S.R., the forecasts of changes in geocryological conditions in newly developed regions are based on the engineering-geological (permafrost) surveys (Fundamentals of permafrost forecasting, 1974) and special investigations of individual processes in permafrost ("cryogenic processes"). Special attention is given to the temperature and the depth of thawing and freezing in the given environmental-territorial complexes (Grechishchev et al., 1977). The temperature forecasts are arrived at by calculations based on the air temperature and the correction coefficients which allow for the characteristics of the given environmental-territorial complexes. The forecasts of cryogenic processes are given in conjunction with forecasts of the thermal and the moisture regimes of the ground based on a classification of the given region with respect to the intensity of these processes.

For example, it is possible to divide heaving into three types: very intensive, intensive, and slight (Nevecherya, 1973). The possibility of occurrence of thermokarst and the intensity of its development are estimated by considering the thawing of ice rich ground beneath the initial water body and during the destruction of the soil cover (Grechishchev et al., 1977).

Much attention, especially in the USA, is given to the disturbance of the tundra cover by various types of vehicles and by animals both in the

summer and in winter, and to the development of transportation facilities which would reduce such disturbances to a minimum (Brown, 1976; Batzli, Brown, 1976; Kempel, 1969, etc.).

To develop forecasts of destructive phenomena, it is important to know the time of their natural stabilization. In this connection, the following examples may be of interest.

In the cuts along the Taishet-Lena railroad, where the unit ice content of permafrost reached 40 - 50%, sloughing continued for 5 - 6 years, after which the slopes were stabilized (Bol'shakov, 1966).

Observations of the cuts in ice rich soils along a highway in Central Alaska indicated that the slopes tended to stabilize after three years (Smith, Berg, 1973).

Intensive slumping and sloughing on the construction site of the settlement of Gaz-Sale in the northern part of Western Siberia stopped after two or three years. Observations there have been going on since 1955 (Sukhodrovskii, 1972). Visible ice content of the upper horizons of permafrost on this site was as high as 40%. The observations carried out in 1976 showed that complete stabilization of the slopes occurred in less than 10 years after the start of construction.

The above examples indicate once more that rapid solifluction lasts for 2 - 3 years, while complete stabilization of slopes composed of ice saturated materials takes place over a period of 5 - 10 years.

Also of interest is the rapid development of a gully caused by construction at the northern edge of Tazovskii, a settlement in Tyumen Oblast. The ground there consists of sand, supes and suglinok. The average unit ice content of the upper permafrost horizon is 10 - 40%. After the tacheometric survey in 1961, the gully increased in size for the following 10 years at an average rate of 6 m per year. This was due to disturbance of the soil and vegetation cover and to formation of snow drifts at the buildings and other structures, while on the surrounding site there was practically no

snow accumulation. In the subsequent 6 years (up to 1976), the average growth rate of the gully was 3 m per year. Thus active development of the gully lasted about 10 years, after which stabilization set in.

Finally, one example of thermokarst stabilization. According to observations in the Canadian Arctic, the tundra sections disturbed by a bulldozer in 1965 subsided in the following summer and the ensuing depressions were partially filled with water. However, by 1968, these sections were stabilized and new vegetation began to appear (Rempel, 1969).

Consequently, the measures of preventing or limiting the destructive processes in newly developed areas should be based mainly on the possible retention of insulating and antierosive properties of the soil and vegetation cover, as well as on the control of the surface runoff and drainage. To stabilize disturbed terrain, timely adoption of measures designed to accelerate the processes which develop in the disturbed environment is occasionally very important. In other words: "Man must not take upon himself the function of the biosphere but must simplify its task" (Shvarts, 1976, p. 67).

Based on this principle, the following steps may be adopted to limit the destructive processes resulting from the development of areas with ice rich permafrost.

1. Induced activation of predicted destructive processes prior to construction, bearing in mind the ability of these processes to attenuate as the new and stable terrain is being formed.

2. Prevention and limitation of destructive processes.

3. Measures to accelerate stabilization of a disturbed surface and formation of a new stable terrain.

All three approaches should be regarded as supplementing each other and therefore can be adopted simultaneously in the case of some projects. The least studied is the first approach. Evidently it can be recommended in specific cases in conjunction with other methods.

The other two approaches are based on theoretical and practical experience. The adopted measures should be aimed, first of all, at controlling the runoff, reducing the water content of the ground and the amount of water on the surface, and insulating the ice rich permafrost. Such measures include: drainage, removal of water from the surface, retention and restoration of the soil and vegetation cover, limited use of vehicles which may disturb the surface cover, limited use of excavation and blasting, sowing of grass, planting of trees and shrubs, use of artificial covers (peat, moss, wood, synthetic materials), and use of fill (sand, granular materials).

As a last step, measures should be taken to improve the esthetic appearance of the area, i.e., additional landscaping, proper location of buildings, highways, etc. to match local terrain, and allowances for recreational requirements.

On the whole, all these steps have one common aim: land improvement in the newly developed area. The final choice of measures will depend on the environmental conditions and the economic feasibility. However, the most reliable solutions will be those based on thorough studies of the area, making it possible to predict the changes in the engineering and geological conditions and to evaluate the recommended land improvement measures.

REFERENCES

- BOL'SHAKOV S.M. Geokriologicheskie usloviya raiona zheleznoi dorogi Taishet-Lena. (Geological conditions in the region of the Taishet-Lena railroad). Materialy USh Vsesoyuz. mezhved. soveshch. po geokriologii, No. 3, Yakutsk, pp. 91-99, 1966.
- GERASIMOV I.P. Sovremennye rel'efobrazuyushchie ekzogennye protsessy. Uroven' nauchnogo poznaniya. (Present day relief-forming exogenous processes. The level of scientific knowledge.). In the book: Sovremennye ekzogennye protsessy rel'effobrazovaniya. (Present day exogenous processes of relief formation. Materialy UP plenuma geomorfol. komis. AN SSSR, Moscow, "Nauka", pp. 7-15, 1970.
- GRAVE N.A. Okhrana prirodnoi sredy na severe Kanady. (Protection of the environment in the Canadian North). In the book: Okhrana okryzhayushchei sredy v oblasti rasprostraneniya mnogoletne-merzlykh porod. (Protection of the environment in areas where permafrost is found). Moscow, "Nauka" (at press), 1978.

- GRECHISHCHEV S.E., KRITSUK L.N., NEVECHERYA V.L., SHESHIN Yu.B. and SHUR Yu. L. Opyt prognoza ismeneniya inzhenerno-geokriologicheskikh uslovii pod vliyaniem khozyaistvennoi deyatel'nosti cheloveka. (Experience in the forecasting of the change of geocryological-engineering conditions under the influence of human economic activity). Ibid, 1978.
- ZHIGAREV L.A. Termodenudatsionnye protsessy i deformatsionnoe protaivanie gruntov. (Thermodenudation processes and the deforming thawing of subsoils). Moscow. "Nauka", 110 pages, 1975.
- ZHIGAREV L.A. Prichiny i mekhanizm razvitiya soliflyuktsii. (Causes and mechanism of the development of solifluction). Moscow, "Nauka", 100 pages, 1967.
- KAPLINA T.N. Kriogennye sklonovye protsessy. (Cryogenic declination processes), Moscow, "Nauka", 296 pages, 1965.
- KONSTANTINOVA G.S. and TYRTIKOV A.P. Ovrashnotermoerozionnyi landshaft morskoi tundrovoi ravniny i ego dinamika. (Gullied, thermally eroded topography of a tundra coastal plain and its dynamics). Vestn. MGU, Ser. Geogr., No. 1, pp. 81-87, 1974.
- KOSOV B.F. and KONSTANTINOVA G.S. Intensivnost' rosta ovragev v osvvaivayemykh raionakh severa Zapadnoi Sibiri. (Intensity of growth of ravines in the settlement regions of northwestern Siberia). Vestn. MGU, Ser. Geogr., No. 1, pp. 46-51, 1969.
- NEVECHERYA V.L. K metodike raionirovaniya territorii po intensivnosti proyavleniya protsessov puchinoobrazovaniya v gruntakh. (On the methodology of subdividing areas according to the intensity of ground heaving processes). In the book: Uskorennye metody inzhenerno-geokriologicheskogo izucheniya neftenosnykh raionov Zapadnoi Sibiri na osnove landshaftnoi indikatsii. (Accelerated method of geocryological-engineering study of the oil-bearing regions of Western Siberia on the basis of the topographical indicators). Trudy VSEGINGEO, No. 62, Moscow, 1973.
- Osnovy merzlotnogo prognoza pri inzhenerno-geologicheskikh issledovaniyakh. (Fundamentals of permafrost forecasting in geological-engineering investigations). Izd-vo MGU, 432 pages, 1974.
- SOLOV'EV P.A. Alasnyi rel'ef Tsentral'noi Yakutii i ego proiskhozhdenie. (Alas relief of central Yakutia and its origin). In the book: Mnogoletnemerzlye porody i sopustvuyushchie im yavleniya na territorii Yakutskoi ASSR. (Perennially frozen soils and the phenomena accompanying them in the territory of the Yakut Autonomous Soviet Socialist Republic). Moscow, Izd-vo AN SSSR. pp. 38-54, 1962.
- SUKHODROVSKII V.L. Ekzogennye protsessy rel'efoobrazovaniya na severe Zapadnoi Sibiri. (Exogenous processes of relief formation in the Western Siberian North). In the book: Geokriologicheskie i gidrogeologicheskie issledovaniya Sibiri. (Geocryological and hydrogeological studies of Siberia). Yakutsk, pp. 53-64, 1972.

- SUKHODROVSKII V.L. Kriogenno-flyuvial'nyi rel'ef Kolymskoi nizmennosti v svete novykh dannykh. (Cryogenofluvial relief of the Kolyma lowland in the light of new data). In the book: Regional'nye i teplofizicheskie issledovaniya merzlykh gornykh porod v Sibiri. (Regional and thermo-physical studies of frozen soils in Siberia). Yakutsk, pp. 26-37, 1976.
- SHVARTS S.S. Evolyutsiya biosfery i ekologicheskoe prognozirovanie. (The evolution of the biosphere and ecological forecasting). Vestn. AN SSSR, No. 2 pp. 61-72, 1976.
- BATZLI George O. and BROWN Jerry Rate - The Influence of Grazing on Arctic Tundra Ecosystems. Arctic Bulletin, Interagency Arctic Research Coordinating Committee, Vol. 2, No. 9, pp. 156-160, 1976.
- BROWN Jerry Ecological and Environmental Consequences of Off Road Traffic in Northern Regions - Proceeding of the Surface Protection Seminar. Anchorage, Alaska, Jan. US Department of the Interior Bureau of Land Management, Alaska State Office, pp. 40-52, 1976.
- EVERETT K.E. Soil and Landform Associations at Prudhoe Bay: A Soils Map of the Tundra - Biome Area. In Ecological Investigations of the Tundra - Biome in the Prudhoe Bay Region, Alaska (J. Brown Ed.). Biological papers of the University of Alaska, Special Report, No. 2, pp. 53-59, 1975.
- Environmental Engineering Investigations along the Yukon River - Prudhoe Bay Haul Road, Alaska Research Proposal, USA CRREL, pp. 1-45, 1976.
- REMPEL G. Arctic Terrain and Oil Field Development - Conference of Productivity and Conservation in Northern Circumpolar Lands. Edmonton, Alberta, pp. 1-9, 1969.
- Terrain Sensitivity, Mackenzie Valley and Northern Yukon, Geological Survey of Canada, 1975.
- SMITH N and BERG R. Encountering Massive Ground Ice During Road Construction in Central Alaska, - Permafrost, 2nd Int. Conf. Washington, D.C. pp. 730-736, 1973.

HYDROGEOCHEMICAL INVESTIGATIONS IN PERMAFROST STUDIES

N.P. Anisimova

Permafrost Institute, Yakutsk, U.S.S.R.

At the present stage of permafrost research, the study of the distribution, occurrence, and temperature regime of perennially frozen earth masses, as well as the peculiarities of their cryogenic structure, ice content, and certain physicochemical properties, is done concomitantly with the study of their interaction with groundwater. In a broad sense, such studies also include cryohydrogeochemical research, inasmuch as upon cooling, freezing or thawing, a redistribution of ionic components between the water, ice and rock takes place.

Special hydrogeochemical laboratory and field research done by the Permafrost Institute of the Siberian Department of the Academy of Sciences of the U.S.S.R., and by a number of other Soviet institutes, has permitted elucidation of the specific cryohydrogeochemical criteria for the formation of frozen earth masses and ice, as well as the hydrochemical indices for cryogenic metamorphism of the content of the water remaining in the liquid phase. Cognizance should be taken of the aforementioned criteria and indices when doing multidisciplinary regional cryohydrogeological research, when studying permafrost-facies conditions, when formulating paleohydrogeological and paleopermafrost models, and when forecasting possible changes in the cryohydrogeological situation in the zone of economic development of permafrost regions.

HYDROCHEMICAL INDICES FOR CRYOGENIC METAMORPHISM OF GROUNDWATER

Depending, firstly, on the temperature and rate of freezing of the aquifers (or thawing of the ice-bearing formation); secondly on the initial

chemical composition of the groundwater and the earth masses; thirdly, on the thickness of the aquiferous horizon; and fourthly on the rate of water exchange; the cryogenic changes in the chemical composition of the groundwater may be very substantial, transitory (or seasonal), reversible, or negligible. The direction, extent, and state of cryogenic change in the chemical composition of groundwater vary widely because the zone of cooling is characterized by a great variety of hydrogeochemical and freezing situations which have specific hydrodynamic and geothermal features.

These processes manifest themselves most fully and clearly in the case of cooling and crystallization of groundwater in arctic and subarctic regions (Neizvestnov, Tolstikhin, 1970). Two phenomena occur here within the permafroze zone: firstly, cryogenic concentration of readily soluble salts (mainly chlorides), with a low eutectic temperature, in the groundwater; and secondly, precipitation of salts with a high eutectic temperature (calcium carbonate, magnesium and sodium sulphate). When contemporary marine deposits cool down, mineralization of the porewater solution in the process of its partial crystallization increases threefold to sixfold due to the accumulation of sodium, magnesium and calcium chlorides. (Ponomarev, 1950; Neizvestnov, 1973; Molochushkin, 1973).

Sometimes, water of analogous composition is also formed in continental deposits when fresh groundwater freezes under special conditions (Anisimov, 1973, 1975, 1976). Central Yakutiya provides two examples of this: firstly, brackish water lenses, with a 4 - 10 g/l sulphate or chloride mineralization, formed when sublacustrian taliks froze, occur in alas depressions at the base of pingoes; and secondly, highly mineralized lenses of subzero groundwater (cryopegs), formed when highly concentrated intraporal solutions from freezing soils contaminated with domestic and industrial wastes migrated into the permafrost, are widespread in the frozen alluvial beds of lower terraces.

The chemical composition of cryopegs is diversified only when their mineralization is comparatively low (3.5 - 6 g/l), and the subzero temperature is high (above -1°C). For example, weakly saline cryopegs with a mineralization of about 4 g/l and a temperature in the range -0.2 to -0.6°C ,

formed when a closed sublacustrine talik froze, contain magnesium and sodium chloride and bicarbonate, whereas cryopegs with a mineralization of 6 - 16 g/l and a temperature in the range -0.5°C to -1°C contain magnesium and sodium chloride, or magnesium and sodium sulphate and chloride.

The higher the mineralization of the initial water, the lower the permafrost temperature of the saline water formation site, and the more the water bearing talik or earth mass is frozen through, the greater will be the concentration of dissolved salts in it and the more uniform will be their composition. Thus, the mineralization of the liquid saline water within permafrost is 35, 60 and 98 g/l, at -2.4°C , -3.2°C and -5.8°C , respectively. The cited examples illustrate the final state of cryogenic change in the chemical composition of fresh groundwater under conditions of freezing in a closed system. In taliks, during the early freezing stages, the water mineralization varies within the range of 1 - 5 g/l, and is usually a bicarbonate. In this case, the criterion of hydrochemical change in the water is its cationic composition.

The increased mineralization of water which accompanies the freezing of water bearing materials leads to its saturation with calcium carbonate, which is partially precipitated. Magnesium bicarbonate becomes predominant in the solution. Moreover, in taliks composed of sand, there is a marked increase in the concentration of sodium ions, which evidently form due to hydrolysis of silicates in the presence of carbonic acid, as the latter is segregated when the water crystallizes. Further increase in the mineralization of the water, when it freezes, leads to precipitation of magnesium carbonate (at pH 8.8 - 8.9) and to accumulation of sodium bicarbonates in the solution. Water mineralization of such composition in a freezing closed talik system may reach tens of grams per liter, whereas in the case of water exchange it does not exceed 1 g/l.

The numerous findings of hydrochemical research on the talik waters of the sandy deposits of Central Yakutiya warrant the assertion that their excessive hardness and their high magnesium bicarbonate (or magnesium and sodium bicarbonate) content are indicative of the first stage of talik freezing, whereas high sodium bicarbonate content is indicative of the second

stage. If suglinok is present in the profile of alluvial deposits, water of the chloride type may form in the course of cryogenic transformations.

The groundwater derived from thawed ground differs in mineralization and chemical composition from the water which saturated it prior to freezing. This view, which is held by a number of authors, is based on the premise that in the process of crystallization of the water when the ground freezes, the hardly soluble compounds are precipitated, whereas the ions of readily soluble salts remain in solution. Upon thawing, such salt-depleted earth masses yield groundwater which is less mineralized. However, this proposition may be considered as one of a number of variants, because the salt distribution throughout the profile is affected by the geological structure (alternation of permeable and impervious materials), the mode of freezing (epigenetic or syngenetic), the water exchange conditions during freezing, etc. For example, the composition and mineralization of waters formed upon the thawing of syngenetically frozen unconsolidated deposits will differ from their epigenetic counterparts.

CRYOHYDROGEOCHEMICAL INDICES CHARACTERISTIC OF THE CONDITIONS OF SEDIMENT ACCUMULATION AND FREEZING OF EARTH MATERIALS

The possibility of using the chemical composition of water soluble salts in a formation for studying its lithofacies structure and mode of freezing was demonstrated upon analysis of copious chemical composition data obtained during research on the frozen alluvial deposits constituting the high and low terraces of the Lena River in Central Yakutiya. In the profile of these deposits, the least saline is the lower part, represented by the sands of the epigenetically frozen riverbed facies. When epigenetic freezing of saturated earth materials takes place, a part of the dissolved salts migrates into the lower, unfrozen beds. The extent to which salts are drawn into the deposits during the freezing process depends on the mineral composition of the water saturating these deposits, on the freezing rate, on the cryogenic pressure, and on the water exchange conditions. When sands freeze in conditions of free water drainage, the change in salt content throughout their profile is insignificant, whereas in a closed system (in separated, freezing taliks, for example), the concentration of water soluble salts increases with

depth. The salt composition may also change during the above process, in accordance with changes in the salt composition of the water in the freezing talik.

The most enriched in salts is the upper part of the alluvial deposit section, represented by the syngenetically frozen supes and suglinok of the floodplain facies. The nonuniformity of the water soluble salt content throughout the profile of these deposits is evidently associated with the diverse conditions of accumulation in different places with the areal redistribution of the salts according to the relief, and with the syngenetic freezing process. On raised portions of the relief (present as well as ancient), the salts in the earth materials are predominantly bicarbonates and sulphates of calcium and magnesium, whereas in depressions, the prevalent salt is sodium chloride, with a significant admixture of sodium and magnesium bicarbonate and sulphate.

Thawing of such ice bearing earth materials gives rise to migration of salts from these materials into the water belonging to the talik which forms under the thermokarst depression. Subsequently, as the lake bottom dries up and the talik freezes, the earth materials become depleted in water soluble salts as the refreezing proceeds, and their qualitative composition changes. This is due to the complex biochemical and physicochemical processes which take place in the talik water, and to expulsion of salts during epigenetic freezing of the earth materials. Such frozen ground which was formed in alas depressions contains less sulphates and more sodium bicarbonate than the earth material between alasses. Natural factors leading to change in the chemical composition of earth materials by the indicated process include, in addition to the thermokarst variant, inundation or swamping of the terrain; or conversely, drying of the terrain, change in the riverbed, encroachment of eolian sands on natural water reservoirs, etc.

Under natural conditions, these processes take place very slowly, but with the intervention of man they may become significant within a relatively short time. Change in the chemical composition of frozen sands may occur even without prior thawing. This is possible, for example, when comparatively high temperature frozen sands are subjected to migration of

highly mineralized interporal solutions emanating from cryopeg lenses or from freezing earth materials which thaw seasonally, or are subjected to migration of sea water associated with encroachment of the sea on land.

Such highly mineralized subzero solutions migrate into frozen earth materials under the action of gravitational and thermal gradient forces, and possibly also by diffusion. Annual repetition of this process over many years causes accumulation of chlorides and sulphates, and a rise in the mineralization of the porewater solutions in the upper layers of the permafrost.

Sodium and magnesium chlorides predominate among the water soluble salts of the upper, more saline, layers of the permafrost, but their concentration diminishes rapidly with depth throughout the section. It has been established that the thicker the annual temperature fluctuation layers, the deeper the highly mineralized subzero solutions can migrate.

Analysis of data on the chemical composition of unconsolidated deposits on the bottom of Van'kina Guba Bay in the Laptev Sea has permitted the thickness of the marine beds to be determined, and has enabled the migration depth of sodium and magnesium chlorides into the frozen, underlying nonsaline deposits to be traced.

Thus, whereas augmentation of the water-soluble-salt concentration downward through the nonsaline frozen bed section is an indication that the beds were frozen in a closed system, a sharp diminution in the readily soluble salt content with depth often testifies to migration of highly mineralized solutions into the permafrost from above.

CRYOHYDROCHEMICAL INDICES FOR THE MODE OF GROUND ICE FORMATION

The study of the origin and development of frozen earth masses is facilitated by research on the various categories of contained ice, namely: injected ice, wedge ice, texture forming ground ice, and fissure ice. Chemical composition studies of the different ice forms yield additional data on the origin and mode of freezing of the enclosing earth masses.

Injection ice formed in the process of pressurized migration and freezing of water in unconsolidated earth materials (in a closed system) has been studied in seasonal and perennial frost mounds, namely, pingoes and hydrolaccoliths. The chemical composition of such ice depends on the chemical composition of the water from which it was formed, on the volume of water, and on the rate of freezing. The chemical composition is not homogeneous throughout the profile of the ice body.

Factors known to be associated with the mineral content of ice are: joint crystallization of the water and salts when the solution reaches eutectic temperature; adsorption of ions on the surface of the ice crystals; and mechanical entrapment of the original water in the intercrystalline space. What salts are thus entrapped in the ice, and in what amounts, depends on the conditions under which the ice phase formed, on the temperature and rate of crystallization, and on the composition and mineralization of the freezing water.

Little information is available on the salt distribution throughout the profile of a freshwater ice formation where the water volume is frozen in its entirety. At the outset, we obtained such data for the ice of freshwater lakes which had frozen to the bottom, and subsequently we set up special laboratory experiments for this purpose. The results obtained were verified by chemical composition sampling done on the profile of a large hydrolaccolith in the Yenisei North and on numerous minor frost mounds in Central Yakutiya.

The aforementioned research established that the upper ice layers, which form most rapidly after the emplacement of water, are more mineralized than the underlying layers. This is attributed to the fact that the precipitated salts and dissolved salts are both drawn into the ice in the process of rapid crystallization. Therefore, these upper ice layers are closest in chemical composition to the water from which the ice formed.

Due to the liberation of heat which occurs when the upper layers of ice are formed, crystallization of the underlying water proceeds slowly, so that the lower layers of ice have a lesser content of mechanically entrapped solution, and consequently, a lesser salt concentration, than the upper

layers. When the water crystallization is slow, not all the salts are drawn into the ice phase. As a result, the correlation between the salts in the ice phase differs from the salt correlation in the residual under ice water. Thus, for example, when water with a magnesium and calcium bicarbonate mineralization of 0.1 - 0.2 g/l freezes, sodium bicarbonate becomes predominant in the formed ice due to the extremely small uptake of magnesium bicarbonate and to the precipitation of calcium carbonate. However, in proportion as the ice becomes thicker, the mineralization of the water increases. Therefore, in spite of retarded ice formation rate, the salinity of the formed ice rises. Its lowermost layers, which formed last from the most mineralized water, show a quite sharp increase in magnesium, sodium and calcium bicarbonates, and in sodium chloride.

In the case of a pingo, if the emplaced water freezes inward from all sides simultaneously, then the highest mineralization occurs in the innermost, finally forming part of the ice core.

Thus, on the basis of the distribution of mineralization and chemical composition of the ice in pingoes, it is possible to determine approximately the composition and mineralization of the water from which such ice was formed, as well as the direction, rate and stages of freezing.

Wedge ice is formed from surface meltwaters and river waters when they get into crevices in frozen earth masses. In Central Yakutiya, wedge ice is similar to snow meltwater in chemical composition (Anisimova, 1971). The mineralization of the ice is usually slight, and in the vertical section it varies little, i.e., 0.05 - 0.09 g/l. A higher concentration of solutes is sometimes observed in the wedge's upper layers, which were evidently partially melted during periods of warmer climate. Calcium, magnesium, and bicarbonate ions predominate in the ionic composition of the melt water.

Wedge ice of similar chemical composition is found in the Yana-Indigirka interfluvium and in the Yenisei North, according to V.P. Volkova and Ye.G. Karpov, respectively. It should be borne in mind that in order to obtain representative data on wedge ice, care must be taken to select samples free of earth or rock inclusions, as these may raise the ostensible mineralization of the melt water considerably.

Texture-forming ground ice generally has a higher mineralization and a more varied ionic composition when it occurs in earth materials which also contain wedge ice. Such mineralization depends on the composition of the water saturated earth materials which produce the texture forming ground ice upon freezing. For example, in Central Yakutiya, sands containing wedge ice also enclose texture forming ground ice. Mineralization in the latter is 0.1 - 0.4 g/l, and its ionic composition includes magnesium and calcium bicarbonates, together with chloride, sulphate and sodium ions.

In the Yenisei North, at the boundary between peat and suglinok, and in glaciolacustrine varved clays, the texture forming ground ice is weakly mineralized (0.03 - 0.07 g/l), but has an augmented sulphate, chloride, and sodium ion content.

Characteristic of texture forming ground ice occurring in unconsolidated sediments is the presence of a certain amount of sodium bicarbonate.

The fissure ice in the bedrock of a frozen zone varies in chemical composition and mineralization. Chemical analysis data on ice samples taken at different depths of a profile through the Upper Cambrian rocks in the vicinity of the "Udachnaya" pipe substantiated the cryogenic processes of the formation of a calcium-magnesium chloride brine, at a depth of 178 - 198 m. At a depth of 70 - 100 m, the ice is fresh, and in composition it is of the calcium bicarbonate - magnesium bicarbonate type, with a mineralization of 0.2 - 0.3 g/l; at a depth of 150 - 170 m, its composition is of the calcium sulphate type, with a mineralization of 1.6 - 2.4 g/l; and at a depth of 180 m, its composition is of the sodium sulphate type, with a dissolved salt content of 4.2 g/l (Ustinova, 1964),

Thus, the foregoing data show that each genetic facies of the ice has distinctive chemical composition features, knowing which, it is possible to conceive the specific mode of freezing and the approximate chemical composition of the water from which the ice was formed.

Icings (ice crusts). Of special interest are chemical composition studies done on icings, namely large volume ice bodies formed in the process

of layer by layer freezing of subterranean or surface water flowing onto the ground or the ice cover, or into large cavities in the rock (caves, adits, etc.).

Detailed research done on the mode of formation of the icings and on their chemical composition, areally and in profile, has demonstrated the possibility of using the observed characteristics to determine the chemical composition and origin of the groundwater which formed the icing, and to establish the location of the water's main discharge onto the surface.

Analysis of copious field data and of special laboratory experiments has established that the factors governing changes in an icing's mineralization and chemical composition, over its area and through its profile, are:

- a) cryogenic metamorphism of the composition of the water forming it;
- b) leaching of salts from its surface layer; and
- c) migration of the mineralization components within its body.

The cryogenic changes in the water's composition are associated with the physicochemical processes which take place during its emergence onto the surface, during its movement over the icing, and during its crystallization.

The water spreading over an icing plays a dual role: on the one hand, it dissolves the salts formed on the icing's surface at the end of discrete floodings or contained in the rime-condensate which settles abundantly at night; and on the other hand, it leaches the salts out of the warmed upper layer of the icing. The mineralization of the water also increases substantially during crystallization. In this process, only a fraction of the salts is captured by the newly formed ice. A buildup of chlorides and bicarbonates of magnesium and sodium takes place in the

solution. The concentration of these compounds in the water is observed to be maximal in March and April, when the water spreads over a considerably greater area than during the colder months. The indicated changes in the composition and mineralization of the water cause an increase in the mineralization of the surface of the icing, from its upper end toward its lower end. In the event of rapid crystallization of the water at very low ambient air temperatures and with relatively limited spreading of water, the ice mineralization increases downstream by a factor of 1.5 - 2. The increase in mineralization is many times greater when a large volume of water is discharged, spreading over a considerable area.

Sometimes the above rule, whereby the mineralization of the ice increases on the surface from the upper end of the icing toward its lower end, is broken, especially during the latter half of its formative period (February-March). This happens when the water courses within the icing and in the subchannel deposits freeze up and the migration of the water discharge foci over the area of the icing begins. This is attended by the formation and bursting of frost mounds, with the outpouring of large volumes of water. These processes, which alter the configuration of the icing, also bring about significant changes in its chemical composition.

The bursting of a frost mound causes an outpouring of water onto the surface, the water's composition and mineralization having been changed, to a certain extent, in the freezing process. As a result, the ice formed from such water is more mineralized. Conversely, in the event of slow crystallization of the water flooding a cavity in the icing, the ice is weakly mineralized, inasmuch as the greater part of the salts is forced out into the lower, subsequently freezing, layers.

In February and March, when the water discharge foci in the icing shift to the middle or the lower area of its surface, weakly mineralized layers of ice are formed there. The indicated local changes in the icing's formation process bring about changes in the mineralization and chemical composition of ice, not only over the surface of the icing, but also in its profile. The mineralization of the ice is reduced considerably by snow falling on the surface of the icing and by migration of mineral components in its profile due to the thermal gradient and gravitational effects.

The indicated significant variability of mineralization and chemical composition areally and in profile shows that the chemical composition of the water from which the icing was formed cannot be inferred from chemical analysis data derived from ice samples taken from the surface of the icing or from its entire profile at any one point on its surface.

The closest values of the mineralization of the original water may be obtained by averaging the chemical analysis results for ice samples taken layer by layer throughout the entire thickness of the icing at three points on its surface, namely on the upper, middle, and lower parts of its slope. To the ice mineralization value obtained on the basis of chemical analysis of the melt must be added the weight of the insoluble salt sediment.

The site of the most intense discharge of water onto the surface may be determined approximately on the basis of the lowest values for the mineralization of the ice.

CRYOHYDROGEOCHEMICAL RESEARCH APPLIED TO ENGINEERING GEOLOGICAL SURVEY AND FORECASTING WORK IN PERMAFROST

The cryohydrogeochemical situation in the permafrost zone may change substantially under the impact of changes in the environment in the process of industrial development of the terrain. Scientific anticipation of the nature and extent of such changes is the principal task of permafrost forecasting. At the present time, work is being done in a number of research establishments to determine the qualitative and quantitative characteristics in the direction, nature, and extent of possible changes in cryohydrogeological conditions.

Inasmuch as permafrost forecasting is done mainly for engineering geological purposes, the research program includes a study of permafrost, engineering geological, and hydrogeological conditions prevailing in each type region, cognizance being taken of possible artificial transformations of the environment (levelling of the terrain, removal of soil from elevations or accumulation of soil in depressions, flooding or drainage, overlaying with coverings, road building, and so on). Moreover, it is extremely important to

study the processes whereby perennially frozen earth masses thaw, or refreeze during economic development of the terrain. Associated with these processes are changes in the chemical composition of the water and earth materials which are sometimes so significant that they cannot be ignored. The relevance of the foregoing to conditions prevailing in Central Yakutiya may be illustrated by the following examples.

1. At one of the construction sites, on the first terrace above the tidal plain of the Lena River, within a few years of the levelling of the site (including filling with sand of the low swampy part), a lense of highly mineralized water, which would not freeze in winter, was discovered at a depth of 2.5 - 3.5 m. This water, having a chloride-sulphate composition, attacked the concrete and was corrosive to the iron reinforcement. Such a phenomenon in the freshwater deposits is the result of ionic concentration of the readily soluble salts during the freezing process of the ground and swamp water above the permafrost.

2. In the Town of Yakutsk, during the long period of its existence, the earth materials of the seasonally thawing layers have been salinized considerably by contamination with domestic and industrial wastes. The perennial migration of the highly mineralized porewater solutions from the freezing layer into the underlying frozen sands led to their salinization to a depth of 4 - 6 m and to the formation of cryopeg lenses. Such water may migrate into the warmed ground under buildings (Mel'nikov, 1952). Where deep underground workings (trenches, boreholes, pits, cellars, etc.) have been open for a long time, the highly mineralized waters of the seasonally thawing layers (or of suprapermafrost and intrapermafrost talik lenses) draining into them penetrate into the deeper horizons of the alluvial deposits. In the environs of the town of Yakutsk, for example, when the site of a dozen boreholes 10 - 22 m deep was built up, after a brief period, the lower half of the alluvial deposits became salinized, and this led to the formation of cryopegs with a mineralization of 25 - 55 grams per liter of magnesium-sodium chloride composition. On this site, the interstitial solutions in the frozen ground contained mainly calcium and magnesium bicarbonates, whereas in a few years after the site was built up, the predominant salts became the chlorides of sodium, magnesium, and calcium, with an elevated content of sulphates. The

given example illustrates that the exploratory boreholes, previously drilled on the site, may become the conduits of highly mineralized interporal solutions from the seasonally freezing layers into the base of frozen earth masses and increase its salinity.

3. A change in the chemical composition of sandy perennially frozen earth materials is also observed on construction sites during the laying of foundations. For example, when steam pipes are pushed into the ground in preparation for pile driving and filling of voids with ground slurry, thawing and then refreezing of the earth materials results. As this takes place, a redistribution of salts in the vertical profile is observed. The upper, more saline parts become less saline upon refreezing (from 0.3 - 0.9% to 0.2 - 0.5%), whereas the salt content of the originally nonsaline lower section increases (from 0.01 - 0.4% to 0.1 - 0.4%) due to the downward migration of salts from the upper layers during the process of thawing and refreezing (Karpunina, 1972).

During construction and use of buildings, a large volume of warm and hot water is often allowed to penetrate into the covered areas and ventilated spaces under the buildings, and this leads to inundation of the active layer and to a rise in the temperature of the underlying permafrost, right up to the thawed state. Concentrated solutions from the seasonally thawing ground beyond the limits of the building migrate into the talik under the building. Elimination of the sources of warm water and the subsequent ventilation by cold air underneath the building bring about freezing of the thawed ground right down to the upper layer of the permafrost. However, the original salinity pattern is not restored, and a redistribution of salt content takes place. The highest salinity occurs in the lowermost layers of the former water bearing talik and in the underlying permafrost. In the probably event of cryopegs occurring, especially at foundation floor depth, these will adversely affect the strength properties of the ground, as will the increased salt content.

4. The thawing and salinization of deposits may also be due to inundation of the terrain when the natural drainage of surface water is obstructed by causeways. Moreover, in the water saturated earth materials

near the road, the annual freezing process engenders highly mineralized interstitial solutions which may migrate into the body of the roadbed.

The cited examples show that when forecasting changes in the engineering geological permafrost conditions, it is essential to take into account the possibility of changes in the natural salinity of the earth materials, and the possibility of augmented concentration of the interporal solutions and groundwater, up to the point of formation of liquid saline water within the frozen ground (cryopegs), which will complicate the building and use of structures in the permafrost zone. Moreover, the research and survey program must include determinations of the salinity of the earth materials in the active layer. It must also include qualitative and quantitative determinations of the dissolved salt content of the suprapermafrost waters, as well as an enquiry into the reserves, supply mechanism, and interchange of this water. Having such data on the chemical changes of the water and the earth materials, it is possible, in any particular instance, to predict the changes, if any, in the hydrogeochemical conditions.

In conclusion, let us note that the cited examples show how promising is the application of cryohydrogeochemical methods to various branches of permafrost research for the resolution of such problems as: the interaction between frozen earth materials and subterranean waters; the characteristics of freezing of such waters; the origin of the ice; and forecasting possible changes in the cryohydrogeological environment associated with industrial development of the permafrost zone. A prerequisite for widespread introduction of this method into the practice of permafrost studies is the formulation of a research program aimed at determining relevant numerical data and establishing an appropriate methodology.

REFERENCES

- ANISIMOV N.P. Formirovaniye khimicheskogo sostava podzemnykh vod talikov (na primere Tsentral'noi Yakutii). (Formation of the chemical composition of talik groundwater (using Central Yakutiya as an example)), Publishing house "Nauka", Moscow, 195 pages, 1971.

- ANISIMOVA N.P. Osobennosti formirovaniya i rasprostranennost' solenykh vod v allyuvial'nykh otlozheniyakh Tsentral'noi Yakutii. (Peculiarities of the formation and distribution of saline water in the alluvial deposits of Central Yakutiya). In the book: Voprosy geografii Yakutii (Problems of Geography in Yakutiya), Issue 6, Gidrometeoizdat, Leningrad, pp. 97-103, 1973.
- ANISIMOVA N.P. Kriogennyye geokhimicheskiye izmeneniya v mnogoletnemerzlykh allyuvial'nykh otlozheniyakh pri khozyaystvennom osvoenii Tsentral'noi Yakutii. (Cryogenic geochemical changes in perennially frozen alluvial deposits during economic development in Central Yakutiya), abstract of report rendered to the All-Union Conference on Conservation of the Environment in Connection with the Economic Development of Permafrost Regions, Yakutsk, pp. 7-8, 1975.
- ANISIMOVA N.P. Sezonnyye izmeneniya khimicheskogo sostava kriopegov allyuvial'nykh otlozhenii. (Seasonal changes in the chemical composition of cryopegs in alluvial deposits). In the book: Gidrogeologicheskiye usloviya merzloi zony (Hydrogeological conditions in the frozen zone), Yakutian Book Publishing House, pp. 60-69, 1976.
- GINSBURG B.D. and NEIZVESTNOV Ya.V. Gidrodinamicheskiye i gidrokhimicheskiye protsessy v oblasti okhlazhdeniya zemnoi kory. (Hydrodynamic and hydrochemical processes associated with the cooling of the Earth's crust), 2nd International Conference on Permafrost Research, Doklady i soobshcheniya (Proceedings and reports), Issue 5, Yakutsk, pp. 22-28, 1973.
- KARPUNINA A.A. K voprosu o prochnostnykh svoystvakh zasolennykh merzlykh gruntov Yakutii. (Mechanical-strength properties of saline frozen ground in Yakutiya), In the book: Stroitel'stvo v raionakh Vostochnoi Sibiri i Krainego Severa (Construction in Eastern Siberia and the Far North), sbornik (symposium) 23, Krasnoyarsk, pp. 3-13, 1972.
- MEL'NIKOV P.I. Dinamika merzloty pod zdaniyami i raschet fundamentov dlya uslovii nizkotemperaturnoi vechnoi merzloty goroda Yakutsk. (Dynamics of frozen ground under buildings, and foundation design under low temperature permafrost conditions in the town of Yakutsk). In the book: Issledovaniya vechnoi merzloty v Yakutskoi respublike (Permafrost research in the Republic of Yakutiya), Issue 2, U.S.S.R. Academy of Science, Moscow, pp. 259-278, 1952.
- MOLOCHUSHKIN Ye.N. K merzlotnoi kharakteristiki donnykh porod vostochnoi chasti Van'kinoi guby morya Laptevykh. (Frost characteristics of the bottom beds in the eastern part of Van'kina Guba Bay in the Laptev Sea). In the book: Voprosy geografii (Problems of Geography), issue 6, Gidrometeoizdat, pp. 123-129, 1973.
- NEIZVESTNOV Ya.V. and TOLSTIKHIN N.I. Vliyaniye kriogeneza na formirovaniye podzemnykh vod artezijskikh basseinov Arktiki. (Effects of cryogenesis on the formation of the subterranean waters of the artesian basins of the Arctic). Abstract of a report rendered to the All-Union Conference on Permafrost Research, Moscow State University Press, pp. 75-78, 1970.

- PONOMAREV V.M. Formirovaniye podzemnykh vod po poberezh'yu severnykh morei, v zone vechnoi merzloty. (Formation of subterranean waters along the coast of the northern seas in the permafrost zone). U.S.S.R. Academy of Sciences Press, Moscow, 95 pages, 1950.
- USTINOVA Z.G. K gidrokhimii kimberlitovykh trubok Yakutii. (Hydrochemistry of the Yakutian kimberlite pipes). In the book: Voprosy geokhimii podzemnykh vod (Problems of the geochemistry of subterranean waters) Publishing house "Nedra", Moscow, pp. 237-252, 1964

USE OF AC CURRENT SURVEYS IN PERMAFROST STUDIES

Yu.A. Avetikyan

Industrial and Research Institute for Engineering Surveys in Construction
Moscow, U.S.S.R.

Large scale development of the northern and eastern regions of the U.S.S.R. gives rise to the necessity for further increases in the efficiency of geological engineering surveys, and, in particular, of geophysical research on permafrost profiles. This paper is concerned with some of the problems associated with designing special equipment, and investigation of theoretical curves, and with widening the scope of AC current surveys by modifications to probing and profiling.

As we know, the method of electromagnetic frequency probing (ChEMZ) used in geological prospecting field-work has greater potential than DC current probing (Van'yan, 1965). The efficiency of ChEMZ is most perceptible in the investigation of profiles containing high resistance horizon screens, in bad grounding conditions, in cases where it is necessary to isolate comparatively thin strata, etc. In the realm of increasing the reliability of information, the possibility of investigating some of the parameters of the field is promising; these include, for example, the horizontal electrical E_x , and the vertical magnetic B_z components and phase characteristics.

During the working out of a slight modification to the method which is applicable specifically to the investigation of the upper part of the permafrost, a number of questions had to be solved. This primarily concerns the designing of basically new equipment that would allow probing in a range of frequencies embracing both low (audio) and high (radio) frequencies. Previously employed methods of measurement also underwent

considerable changes (Avetikyan, 1971). Extension of the range by 2 - 3 orders into the high frequency range established the necessity of calculating the permittivity ϵ , i.e., the development of a new computer of displacement currents (Dmitrev, 1968; Avetkyan, Rogulin, 1972). Master curves are constructed from the results of calculations of amplitudes of the magnetic component B_z of the electromagnetic field on the surface of the conductive half space. The source of excitation is the horizontal electrical dipole equatorial arrangement.

The ChEMZ master curves usually take the form of graphs of the dependencies $|\rho_\omega|/\rho_1$ on λ_1/h_1 for various constant values of r/h_1 , and the relationships $\mu_m = \rho_m/\rho_1$ and $\nu_m = h_m/h_1$ are fixed as output (here ρ_ω is the apparent specific resistance, ρ_m is the specific resistance of stratum number m , h_m is its thickness, λ_1 is the wave length in the first stratum, and r is the separation). In contrast to the quasistationary case in calculations allowing for displacement currents, the supplementary parameters $k_m = \epsilon_m/\epsilon_0$ and $\gamma = \rho_1/h_1 \cdot \sqrt{\epsilon_0/\mu_0}$, were introduced, where ϵ_0 and μ_0 are the permittivity and permeability air (vacuum), ϵ_m is the permittivity of stratum number m . The parameter γ indicates the degree of influence of the displacement current and can be replaced by the parameter ρ_1/h_1 , in so far as $\sqrt{\epsilon_0/\mu_0} = \text{const}$. In Figure 1 an illustration is given of the effect of displacement currents on the behaviour of the two strata curve ρ_ω (the curve for quasistationary approximation is shown without an index). Here $\mu_2 = 9$, $r/h_1 = 20$. The values ρ_1/h_1 (1, 5, 25 and 125) are given in the chart.

Computations of theoretical curves showed that for frequencies of less than 5 - 10 MHz, in most practical cases, the permittivity of the lower half space can be taken to be equal to the permeability of a vacuum. This allowed the number of master curves to be reduced several times. This is supported in Figure 2, where two curves are given for the very same parameters of the medium ($\mu_2 = 81$, $\rho_1/h_1 = 25$, $r/h_1 = 20$), $k_1 = 1$ and 10.

Figure 3 illustrates the effect of the variable parameter μ_2 on the nature of the curves. Here, are presented theoretical two strata curves for $\mu_2 > 1$ (81, 27, 9, 3) and $\mu_2 < 1$ (1/3, 1/9, 1/27, 1/81, 1/270, 1/810); the figures on the curves denote μ_2 . The separation is fixed ($r/h_1 = 20$, $\rho_1/h_1 = 5$).

Figure 1

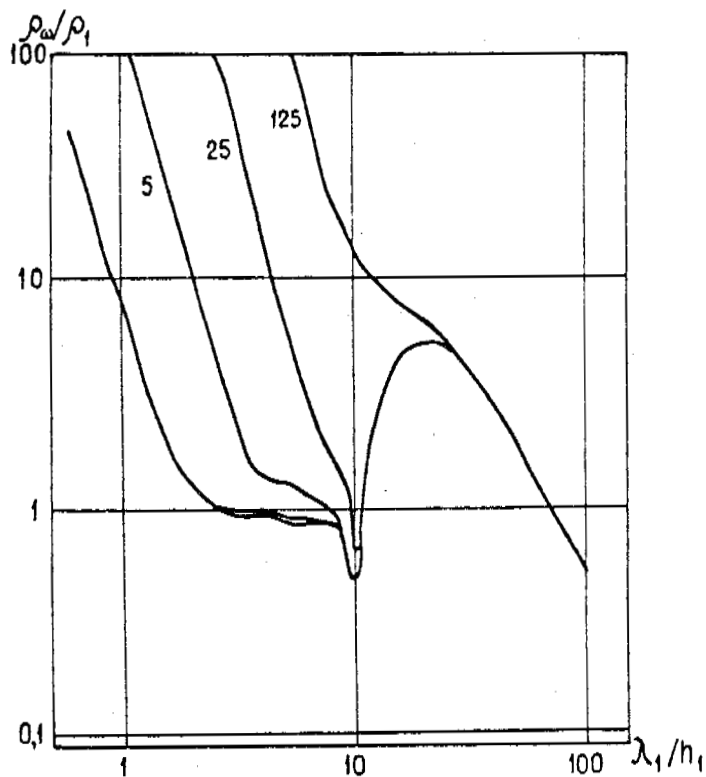

Influence of displacement currents

Figure 2

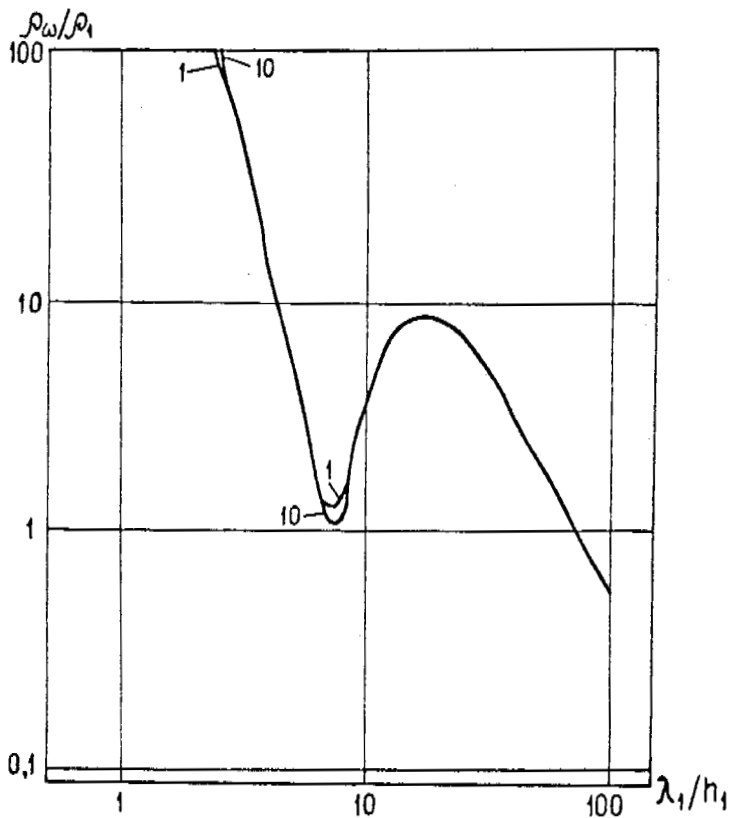

Theoretical curves for two values of permittivity k_1 .

Figure 3

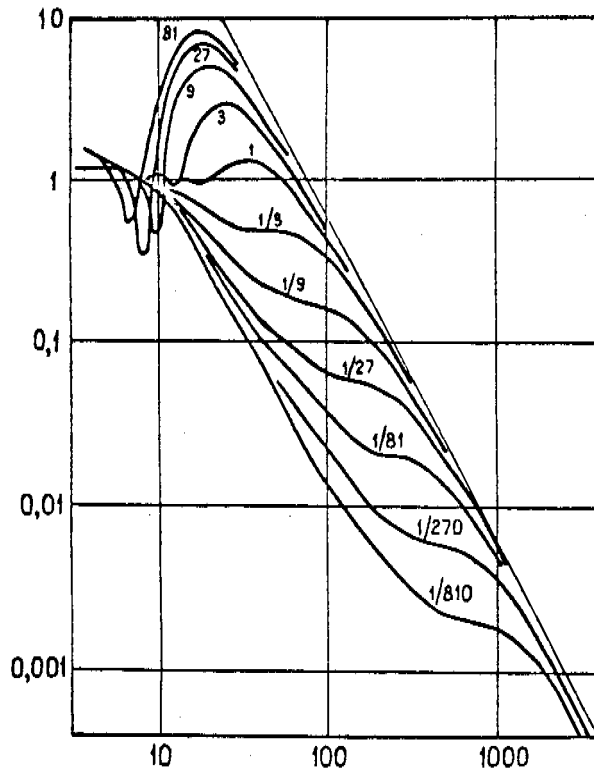

Two-strata curves for different values of μ_2 .

Figure 4

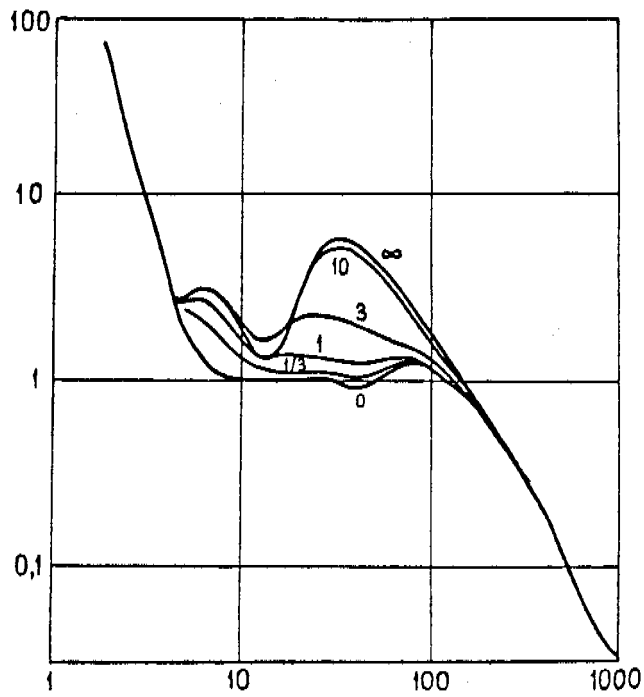

Three-strata curves for different values of ν_2 .

Figure 4 shows the three-strata curves of type "K". The variable parameter is the dimensionless thickness of the second stratum ($v_2 = 0, 1/3, 1, 3, 10$). The remaining parameters are fixed ($\mu_2 = 9, \mu_3 = 1, \rho_1/h_1 = 5, r/h_1 = 45$). The diagram allows the degree of transformation of the curves to be determined for changes in thickness of the second stratum. Curves with the indexes 0 and ∞ illustrate cases where the cross section degenerates into a homogeneous half space ($v_2 = 0$) or into a two-strata section ($v_2 = \infty$).

The three strata curves for variations of the parameter μ_2 are indicated in Figure 5. The values for μ_2 are given in the chart. The remaining parameters are fixed ($\mu_3 = 1, v_2 = 3, \rho_1/h_1 = 5, r/h_1 = 67.5$). The curve with the index $\mu_2 = 1$ characterizes the homogeneous half space.

Figure 5

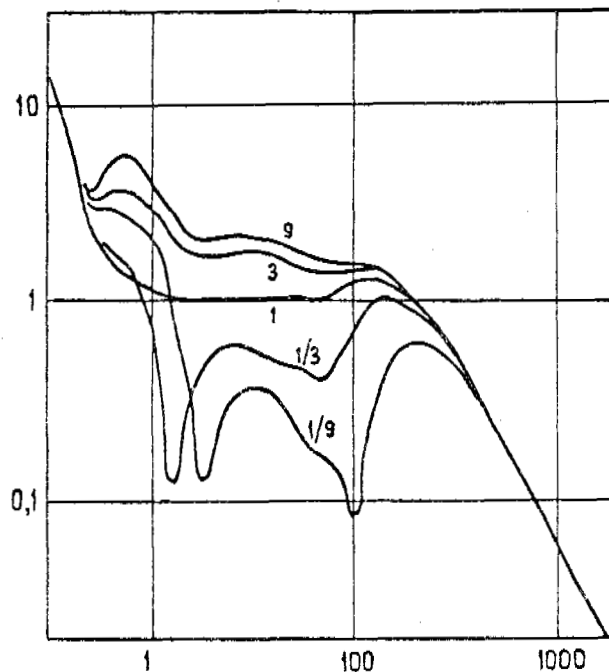

Three strata curves for different values of μ_2 .

The ChEMZ equipment and the methods of field measurement were worked out under various geological conditions. The ChEMZ results were compared with data from drilling operations in mining, and by geophysical methods. Testing of experimental models of equipment took place in various regions of East and West Siberia, in the Bol'shezemel'skya Tundra, near the Baltic Sea, around Moscow, and in the Ukraine.

The ChEMZ field equipment is a comparatively complex set of apparatus, the main units of which are the generator (for excitation of the electromagnetic field in the ground) and a recording discriminating receiver - a microvoltmeter. The first experimental models of the station are designed for realization of the discrete mode of measuring by the ChEMZ method concluding in the subsequent study of a number of frequencies with simultaneous recordings of this signal at a specific distance from the generator grouping. All measurements are carried out with a fixed separation r between the generator and the receiver. Measurements in the continuous frequency spectrum (so-called "continuous frequency probing") are rendered difficult by the complication of providing for automatic tuning of a receiver for a generator frequency varying within a wide range. Use of a wide band receiver without selective tuning is impossible due to low noise stability.

When an electromagnetic field at the Earth's surface is excited, currents are induced in its various strata, the amplitude of which is dependent upon the geoelectric characteristics of the medium. Some of these can be determined from observations in the field. The shallower the signal's depth of penetration into the Earth, the higher the frequency of the signal. Therefore, results of high frequency measurements are used for studying the upper layers, and vice versa.

The ChEMZ station has been developed in two modified forms: the ChZ-100 and the ChZ-10. The basic parameters of the ChZ-100 station are given below:

Generator

Frequency band.....	80 Hz-6 MHz
Nominal rated output (in the range up to 1.5 MHz).....	100 W
Maximum load capacity.....	3 A
Accuracy of recording load.....	$\pm 1.5\%$
Efficiency.....	55%
Weight, (without power supply units).....	13 kg

Receiver

Frequency band.....	80 Hz-6 MHz
Amplitude of signals being measured.....	10 μ V-100 mV
Error.....	$\pm 2\%$
Impedance.....	700 k Ω
Band width, Δf ,.....	0.03, 0.3 and 3 kHz
Selectivity with detuning of $2 \Delta f$	40
Reduction of interference at frequency 50 Hz.....	60
Input current.....	40 mA
Weight (with power supply units).....	5.5 kg
Air temperature interval in which accuracy of measurement is sustained.....	from -35 to +50 $^{\circ}$ C

The station ChZ-10 is a lighter variant of the ChZ-100 (the weight of the generator together with the power unit is 9 kg): it has a lower output (10 W) and a somewhat narrowed frequency range. The receiver impedance of the ChZ-10 station is increased to 10 M Ω and the input capacitance is lowered to 2 pF. An output current stabilization system is introduced into the generator (covering the whole frequency range) and the feasibility of connecting loads of a capacity nature is guaranteed. The above measures are taken with the aim of using the ChZ-10 for continuous high frequency non-contact profiling using capacitive folded dipole antennae.

Depending upon the geoelectric conditions, the depth investigated by stations ChZ-100 and ChZ-10 is from 1 - 3 to 70 - 150 m and from 1 - 3 to 30 - 71 m respectively.

The designing of stations with similar parameters required nonstandard solutions for construction both of the individual units and of the functional system as a whole. For example, the following is a special feature of the station's powerful generator (Figure 6). The signal from the low power master generator 1 feeds directly into the input of the resistor phase inverter 2, which is working in a low current state, and a further amplification of the signals of opposite phase takes place separately, that

is, by the two symmetrical aperiodic amplifiers 3 and 5. The load of these amplifiers is a push-pull output stage 7 of class "B" on the input of which are installed the emitter followers 4 and 6. The generator schema is protected by the U.S.S.R. Inventor's Certificate No. 426213.

Figure 6

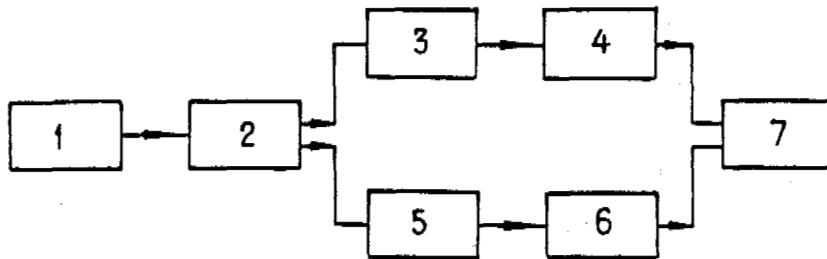

Block diagram of generator.

Figure 7

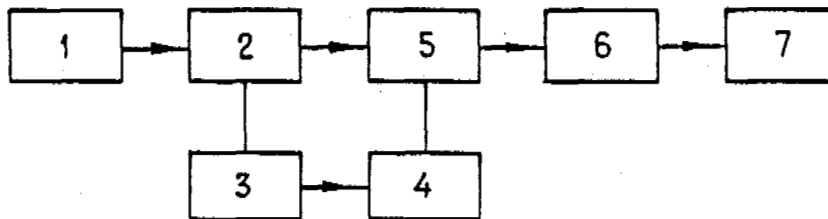

Block diagram of receiver.

The block diagram of the selective receiver-microvoltmeter also has several functional specialties. Resonance inductive systems are excluded from all of its units. By discarding heat sensitive elements, stability and accuracy of measurement was assured in a wide temperature range along with uniform sensitivity in the frequency range from tens of hertz to several magahertz (linearity of the amplitude frequency characteristic of the selective amplifier circuit). The basic components of the schema are: mixer with mixed signal detector 2, heterodyne 3 with detector 4, and phase modifier 5. Blocks 1, 6 and 7 are input circuits with preamplifier, low frequency filter, and amplifier with recording system, respectively. In phase modifier

5, readout of the detected mixed signal takes place with the aim of having a much weaker heterodyne signal and a simplified low frequency filter. The special unit comprising the elements 2 - 5 realizes the function a balance modulator, but unlike the latter, it is efficient in a wide frequency range.

We will give examples of the use of a ChEMZ station. The data shown in Figure 8 were obtained in the permafrost region. According to data from drilling within the designated area of the town, a thin layer of suglinoks can be traced; its lateral extent is insignificant. The geological section (borehole 114) and the geoelectrical section according to data from the ChEMZ are given in the diagram. The lower limit of the layer of seasonal thaw is marked by the broken line. The ChEMZ field curves are given together in the form of graphs of dependence of ρ_{ω}^E (according to the results E_x) and ρ_{ω}^B (according to the results B_z) on \sqrt{T} (where T is the period of fluctuation). For comparison, the curves ρ_k of vertical electrical probing (VEZ) by direct current are given.

When processing data from a profile survey, the boundaries of geoelectric horizons are established with respect to the dislocation of characteristic sections and points of the ChEMZ curves (the line S, according to the coordinates $\sqrt{T_{\max}}$ and $\sqrt{T_{\min}}$).

In most cases, interpretation of ChEMZ was by the master curve analytic method, the results of which indicated the presence of a thin low resistance horizon at a depth of 12 - 16 m. During direct current probing, the layer of reduced resistance is weakly displayed only on the VEZ-4 at one point; this does not allow the possibility of determining its parameters.

When selecting research methods, economic efficiency is an important factor. The proficiency of ChEMZ, placed IV in complexity, is 2 - 3 times higher in comparison with direct current VEZ (in summer conditions, with separations guaranteeing identical profundity of methods). In this case, an operating team for ChEMZ consists of 3 - 4 persons, for VEZ the operating team is 5 - 7 persons.

Figure 8

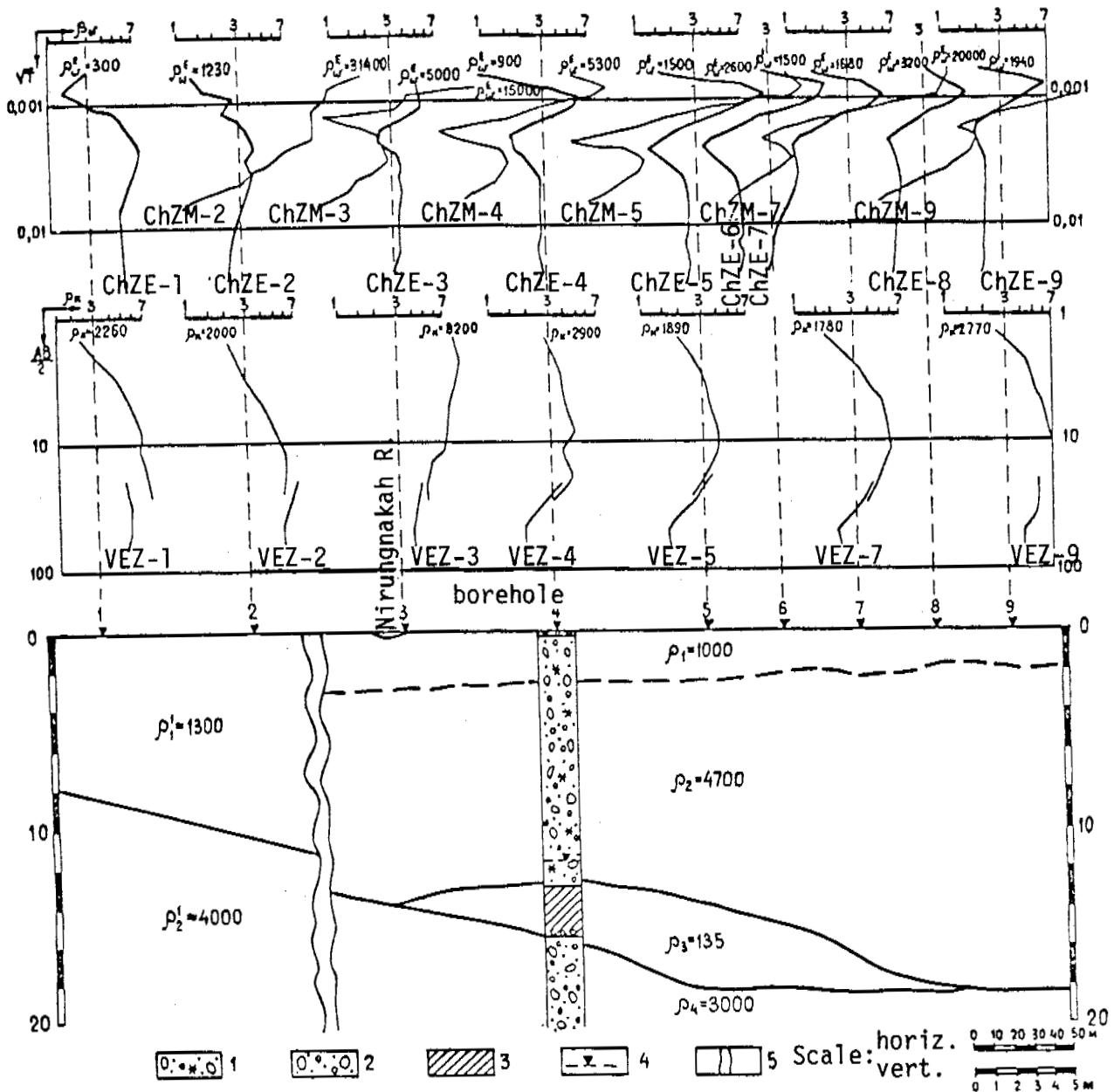

- Geoelectrical cross-section according to ChEMZ results.
- 1 - gravel and shingle with boulders and sandy filler, frozen;
 - 2 - as above, thawed;
 - 3 - suglinok;
 - 4 - level of groundwater;
 - 5 - proposed zone of dislocation.

Figure 9, which shows the logging curve, illustrates the potential of the ChEMZ station even for this type of work. Logging took place in a dry, uncased borehole by means of a noncontact magnetic receiving antenna; a field was excited at the Earth's surface.

Figure 9

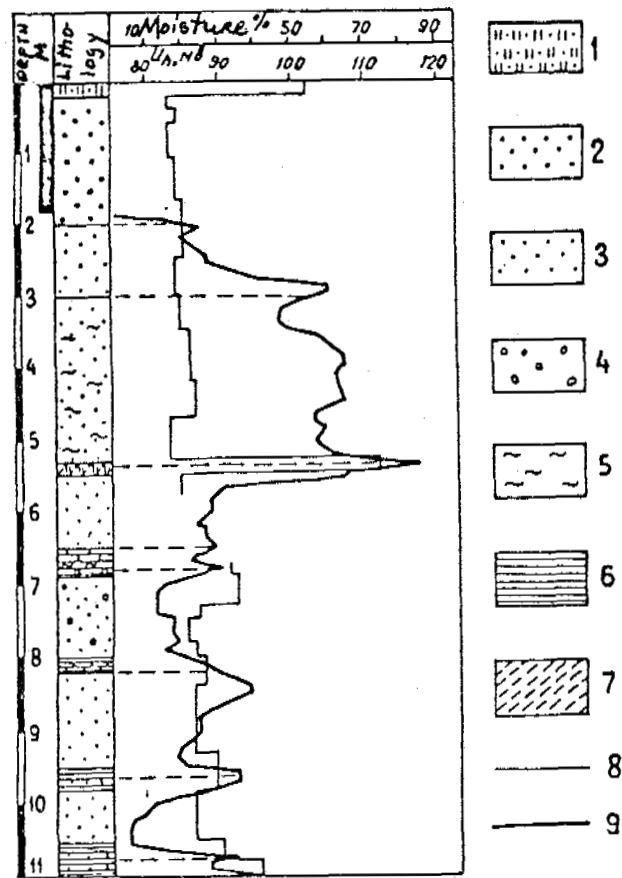

High frequency logging of borehole.

- 1 - peat; 2 - coarse sand; 3 - fine sand;
- 4 - pebbles; 5 - ice veins; 6 - clay; 7 - supes;
- 8 - moisture; 9 - μ_h ($f = 0.3$ mHz).

The ChZ-10 station together with ChEMZ can be used even for high frequency electromagnetic profiling (VChP). Initially, electroprofiling took place with an equatorial arrangement (by analogy with frequency probing). Both the electric E_x , and the magnetic B_z component of the field are measured. These measurements, which have several advantages over DC electroprofiling, produce no substantial advantage in proficiency. At the All Union Research Institute for Hydrogeology and Engineering Geology (VSEGINGEO), and subsequently in the Industrial and Research Institute for Engineering Surveys in Construction (PNIIS), research has been carried out into another modification of electroprofiling. Observations were usually carried out in the 1.0 - 200 kHz band of the axial dipole arrangement. One example of the use of VChP (on four frequencies) for isolation of zones of tectonic disturbance is shown in Figure 10.

Figure 10

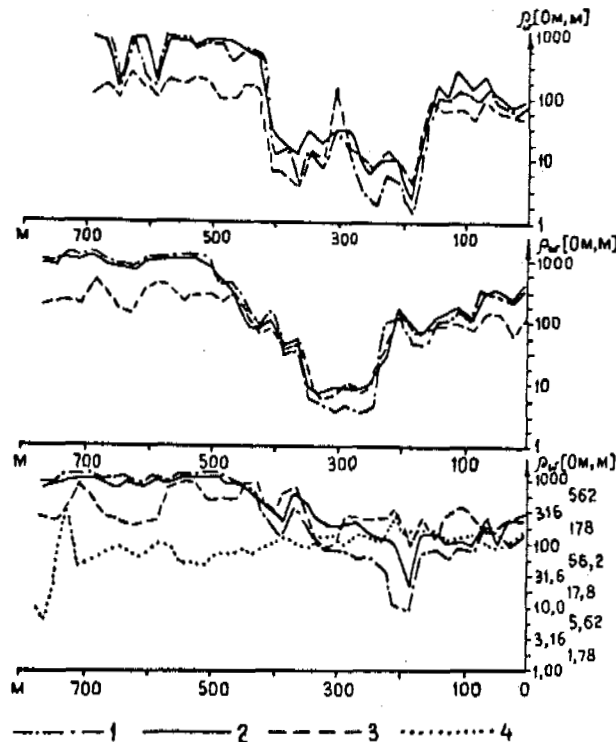

Profiling on four frequencies.

1 - 1 kHz; 2 - 10 kHz; 3 - 100 kHz; 4 - 1 MHz.

Use of noncontact capacitance antennae (length 5 - 10 m), pulled freely behind the measuring instruments of the ChZ-10 station, allowed the speed of profiling to be accelerated several times and the work team to be reduced to 2 - 3 persons. Its possibilities and the quality of the results of VChP are in no way inferior to those of DC profiling.

The efficiency of alternating current methods can be increased both from the point of view of reliability (quality), and productivity - in the latter case it can be greatly increased. To this end, methods of measurement and design of special equipment for their realization must be developed. Recently, methods for amplitude and amplitude-phase-measurement and equipment setups for geoelectrical AC surveys have been proposed by the PNIIS (Avetikin, 1976). All of the methods propose use of a supplementary channel (UHF) between the generator and receiver groups. This channel is for transmission of a special reference signal for selective tuning of the receiver.

In the amplitude measurement procedure, the frequency of the reference signal must be shifted to a constant value in relation to the frequency of the emitter, independent of its fluctuation. At the same time, use of a heterodyne receiver allows isolation of the beat frequency that arises from mixing signals of two frequencies: emitted into the ground and transmitted through the UHF channel. Use of such a method of measurement guarantees the automatic tuning in of the receiver to the emitter signal without any additional time being spent on it and, consequently, the realization of continuous frequency probing (as opposed to measurements on 2 discrete frequencies) with selective tuning. Another positive result is seen in the possibility of considerable narrowing of the pass band of the receiver (down to the first hertz units), i.e., a sharp improvement of its selective properties. The arrangement for such a method of measurement by the basic units of the ChEMZ or VChP stations must contain a device for forming a reference signal, and a UHF transceiver. The necessary reference signal can be obtained in this device by means of a phase discriminator similar to that used in radio communication procedure in a single sideband.

The other method - phase frequency - suggests simultaneous recording of amplitude and phase of the signal with continuous alternating frequency (ChEMZ) or signal of a fixed frequency with continuous change of amplitude and phase (VChP). This method, in contrast to the former, allows two parameters of the field to be recorded, but requires equipment of greater complexity. Among the latter must be included a follow-up system for compensating the phase difference, two synchronic (phase) detectors, and two automatic recorders.

The third method proposed is based on modulation of the phase signal transmitted into the ground.

It is obvious that a ChEMZ station realizing one of the methods indicated will give the most economic result in a system of continuous frequency probing, i.e., when recording amplitude frequency or phase frequency (or both at the same time) characteristics of the medium in a continuous sector of the frequency spectrum. Depending on the established frequency range, the period of measurement when carrying out geocryological engineering

surveys will total several minutes, and the time necessary for additional work will also be reduced. Appreciable improvement in the selective properties of the receiver permits the power of the generator to be reduced considerably, and consequently the weight of the whole ChEMZ station. The measurement process does not require the presence of an operator at the generator group, and the operating personnel can be reduced to one or two persons.

Electromagnetic profiling can also be efficiently carried out continuously which, in a given instance, suggests simultaneous recording of amplitude and phase characteristics of the medium at fixed frequencies, but with continuous transporting of the apparatus through the profile being investigated. In this case, the performance of the VHChP is fully determined by the maximum possible speed of the transportation method under local conditions.

REFERENCES

1. AVETIKYAN Yu.A. Avtomatisheskoe i izmerenie amplitudy i fazy pri geolektrorazvedke peremennym tokom (Automatic amplitude and phase measurement during AC current surveys). "Inzhenernye izyskaniya v stroitel'stve", No. 5 (46), M., pp. 17-19, 1976.
2. AVETIKYAN Yu.A. and POGULIN N.D. Primenenie maloglubinnoi moifikatsii chastnogo zondirovaniya pri inzhenerno-geologicheskikh izyskaniyakh i paletki s uchetom tokov smeshsceniya (Minor modifications to frequency probing in geological engineering research and master curves with respect to displacement currents). "Trudy PNIIS", Vol. 22, M., pp. 3-58, 1972.
3. VAN'YAN L.L. Osnovy elektromagnitnykh zondirovaniy. (Principles of electromagnetic probing). M., "Nedra", 120 pages, 1965.
4. DMITRIEV V.I. Obshchii metod rascheta elektromagnitnogo polya v sloistoi srede. (General method of calculating a magnetic field in a layered medium). "Vychislitel'nye metody i programirovanie", No. 10, Izd-vo MGU, pp. 55-56, 1968.

FORECAST OF CHANGES IN GEOCRYOLOGICAL CONDITIONS DURING
ECONOMIC DEVELOPMENT OF THE PERMAFROST REGION

V.A. Kudryavtsev and L.N. Maksimova
Moscow State University, U.S.S.R.

Geocryological forecasting is becoming an integral part of the following branches of permafrost research: geocryology, geological engineering, hydrogeology, etc. However, while there is no consensus on types, content, methods, objects, forms and complexity of forecasts, there is also no classification system or nomenclature. As a result, the aims and tasks are perceived in different ways. Therefore, it is now expedient to discuss these questions in order to determine the best methods and the relationship of individual types and forms of forecasting in the prediction of changes in geocryological conditions and in determining the principles and methods of modifying the "cryogenic processes"*; and for predicting the principles and methods of environmental protection in permafrost areas.

Aims, Tasks and General Forecasting System

By geocryological forecasting is meant: the scientific prediction of changes in geocryological conditions and the disturbances brought about in the environment by natural evolution and human intervention.

In a permafrost region, the resistance of the environment to external influences, the principles and methods of construction and the mode of operation of buildings and other structures are all basically determined by the geocryological conditions, which change radically as a result of economic development of the area. These changes can be of such a magnitude that permafrost may form during construction and development of projects, where it had been non-existent during preliminary geocryological research,

* Physico-geological processes resulting from energy and mass exchanges in freezing, frozen and thawing earth materials (Transl.).

and conversely, there can be thawing of permafrost which, under natural conditions, would be sufficiently stable. Obviously, the nature of these changes must be taken into account when determining the general system and optimum conditions for the broad economic development of the vast areas of new industrial-economic regions, just as in the planning, constructing and development of local engineering projects; it is particularly important in the latter case. Therefore, the compiling of a forecast must be an integral part of any geocryological research, and it must form the basis of any development on terrain which has permafrost or deep, seasonal freezing.

When compiling a forecast, it is necessary to evaluate the interaction of the environment and technical factors (civil engineering, mining, agricultural development, etc.). The outcome of this interaction is conditioned by: a) the type of environment and, above all, by the environmental-historical features of the area being developed; features which determine the range and nature of the geocryological factors (e.g., geological structure, landscape, climate, natural cover, etc.), and the significance of each one in the formation of the natural geocryological conditions; b) the nature of man's industrial activity, its role in changing these and other geocryological factors, and also the nature of these changes. Therefore, in order to compile a forecast, both the general and the individual formation patterns and development of the conditions must be studied. With the knowledge of how the industrial activity will influence the environment, it is possible to predict changes in the conditions. Moreover, technical factors displaying an additional influence will usually become evident, e.g., heat release from buildings and structures, etc.; these must also be taken into consideration. These factors are also the subject of research with regard to the characteristics of the existing environmental and geocryological conditions and those undergoing modification.

Types of Forecast

Depending on the aims and tasks of the research at hand, three types of forecast can be distinguished: general, regional and local (cf. Table).

GEOCRYOLOGICAL FORECASTING

Aims and Tasks		I. To reveal general trends in the cryogenic processes in connection with evaluation of projected economic development of natural regions, areas, etc.	II. Evaluation of resistance of geocryological conditions (and of the environment) in order to determine the principles and methods of rational development of the region.	III. Geological-engineering evaluation of local building sites (mineral deposits).
Type of forecast	According to research	GENERAL	REGIONAL	LOCAL
	Due to changes	Basic	ENVIRONMENTAL-HISTORICAL	ECOLOGICAL
	Supplementary	Physico-technical	Environmental-historical, technogenic	TECHNOGENIC Environmental-historical, ecological
Objects of the forecast	Full	<p><u>Type of permafrost and seasonally frozen (thawed) layers SFL (STL)</u></p> <p>According to geological and geographical condition (geological structural elements of the Earth's crust, landscape and type, etc.) and age (period of climate fluctuation</p> <p>According to features of heat exchange determining the resistance of the thermal condition of earth materials for local landscapes, geological structures, etc.</p> <p>According to composition, structure and heat exchange condition for local, natural microregion in the region influenced by the building site.</p>		
	Partial (examples)	<p><u>Individual (and combined) characteristics of geocryological conditions</u></p> <p>1) History of permafrost development; 2) dynamics of southern permafrost boundary; 3) change in distribution area of permafrost and its influence on the dynamics of supply and discharge of subsurface water and estimate of resources; the working out and evaluation of industrial resources of minerals.</p> <p>1) Change in occurrence of permafrost, its influence on the flow of subsurface water and conversely the influence of modified water exchange on the thermal condition of the permafrost; 2) the dynamics of the annual heat exchange, its influence on the heat and moisture exchange on local landscapes and conversely, the influence of changed landscapes on the STL (SFL)), etc.; 3) cryogenic and attendant processes (thermokarst, swamp, etc.).</p> <p>1) Change in depth and occurrence of permafrost, formation of basins and thaw basins, etc.; 2) temperature regime of permafrost, change in its conditions (plasticity and rigidity); 3) characteristics of STL (SFL), norms of depth, potential for freezing, etc.; 4) cryogenic, geological engineering processes (thermal settlement, heaving, etc.).</p>		

Methods	QUALITATIVE - DESCRIPTIVE	logistical and visual - aero - and cosmic methods, etc. (during feasibility studies)	
	Logistical	logistical and visual - aero - and cosmic methods, etc. (during feasibility studies)	
Content	<u>Approximate</u> - computation by empirical and other formulae; input derived from the literature	(from the period to field field investigation)	
		SIMULATION	
		Analog and digital computation	Analog and digital computation, simulation of processes.
		EXPERIMENTAL SITES	
	Study of experience of economic development of the area	Observations of the regime on permanent, experimental construction sites	
	COMPLEX METHOD		
	Permafrost survey on both small and average scale	Permafrost survey on both average and large scale	
	1) General geocryological character of terrain associated with anticipated changes in the 2) rough assessment of influence of geocryological conditions on natural resources; 3) research on the possibilities of increasing resources as a result of modification of geocryological processes.	1) Evaluation of changes in the geocryological conditions due to different types of development; 2) recommendations on the rational organization and location of territorial-economic complexes recreational areas, etc.; 3) the establishing of principles for modifying the geocryological conditions to increase the resistance and to protect the environment.	1) Forecast of geocryological engineering conditions of construction sites; evaluation of their complexity, designation of standards for permafrost features, etc.; 2) establishing of principles and rational construction methods; 3) working out of a system of modification measures for cryogenic processes to create optimum conditions for project development and environmental protection.

The general forecast is compiled to give an overall picture of the type of natural resources over a wide area, with a view to evaluating the perspectives for their economic development (bridging of rivers, creation of a series of reservoirs, etc.). The main function of this type of forecast is to evaluate the general trends in geocryological conditions. In the course of forecasting, the perennial freezing and thawing pattern of the upper layer of the Earth's crust is described, together with anticipated changes in its composition, structure, and characteristics; research is carried out on its influence on the type of permafrost distribution (discontinuity, position of southern boundary). A study is made of the influence of forecast changes in conditions on the evaluation of industrial reserves of minerals, subsurface water, etc. Present trends of permafrost evolution are conditioned by the whole historical development of the permafrost and of the environment as a whole. The evolution of the environmental-historical condition is, in this case, manifest in the origin of the changes being forecast. The changes in conditions it has brought about are assessed by the environmental-historical forecast.

Technical factors such as air pollution, the influence of large, man-made reservoirs, etc., are having an ever increasing effect on the development of the environment over vast areas. This type of technical activity, often called unintentional effects, also influences the geocryological conditions and should be considered when compiling a general forecast. Their influence is imposed on the natural development of the geological and geographical conditions; consequently, there can be said to be an integrated physico-technological effect. When this extends over a vast area, it causes changes in the geocryological conditions, the distribution and timing of which could not be noted earlier with any essential degree of certainty. A forecast of such changes can be called physico-technical "anamological" forecast (from the Greek, meaning rule).

It follows that a general forecast must be based on the results of environmental-historical and physico-technical "anamological" forecast.

Regional forecasts are compiled for geocryological engineering evaluation of terrain during the planning stages of projected agricultural

development, and for other cases where the nature of possible changes in conditions of individual natural regions must be known (land, minerals, etc.). On the strength of the forecast, land is divided into the most suitable regions for various types of development (hydrotechnological, industrial, transport, construction, etc.), and other questions related to the organization and distribution of territorial-economic complexes are resolved. An evaluation of the resistance of the environment in general, and the geocryological condition in particular, to the various external influences must be assessed, if the above mentioned questions are to be resolved. This involves the forecasting of changes in the geocryological conditions resulting from natural development of the environment (environmental-historical forecast) and economic development of the terrain (technogenic forecast). In the latter case, the influence of such general measures as the removal of vegetation, build-up or removal of snow cover, changes in surface and subsurface drainage conditions, etc. are examined. These measures influence the geocryological condition by way of the above listed and other environmental and permafrost forming factors, and are evaluated on the basis of a physico-technical forecast. The above technical influences are characteristic of the economic development of virtually any area. In addition, there must be assessments of the specific influences characteristic of various types of economic activity and peculiar to specific types of construction, etc., in order to resolve a number of questions concerning the locating of territorial-economic complexes. For example, in construction development, the influence of the total thermal heat-release from buildings and engineering projects over the whole construction site, utility corridor, etc. A forecast assessing such purely technical, direct, thermal (mechanical) action on the earth materials can be called eudio-technical (eudio pure, clear). For the practical solution of these problems, a eudio-technical forecast is compiled mainly on the basis of an overview of available construction experience, by means of qualitative evaluations.

Consideration of the above listed influences is not the only function of the regional forecast. In order to evaluate the resistance of the geocryological conditions, it is not sufficient merely to study how they are influenced by environmental and technical factors, for, conversely, the

influence of permafrost conditions on the environment must also be studied. If these influences do affect the conditions, then the impact of the external influence is strengthened and results in low resistance in natural landscapes and their respective seasonally and perennially frozen earth materials. Conversely, other factors which would increase the resistance of the environment and the geocryological conditions are possible. The nature of the above interactions and interdependencies should be the subject of an independent forecast: an ecological forecast. When compiling a local forecast for use in working out the principles of territorial development and environmental protection, an ecological forecast is obviously of prime importance.

The local forecast is designed to help in the engineering logistics of local construction projects (or mineral deposits). On the basis of this forecast, geological engineering evaluations of the terrain are made, from the standpoint of local industrial experience, and the principle to be used for the foundations (or the extraction method for minerals) is selected. The forecast is the basis for all major decisions concerning a project, and for the determination of the standard characteristics of seasonal and perennial freezing; of recommendations on measures to be taken concerning modifications to permafrost conditions, which would ensure rational use of the geological environment (and, when necessary, of recultivation); and optimum conditions for civil engineering and mineral extraction.

The basic function of a forecast of this type is to assess the influence of local technical activity on the geocryological conditions; to this end, a technical geocryological forecast is compiled. This involves assessment of the role and significance of all permafrost-forming environmental factors with regard to changes they undergo during the construction period (physico-technical), and the influence (thermal and mechanical) of local engineering projects (eudio-technical forecast). The general background of the changes in conditions being studied is determined by its historical development and its present day dynamics. The peculiarities of the above factors and their influence on local construction sites are assessed on the basis of environmental historical and ecological forecasts. In the latter case, features of the interaction of the geocryological

component and the environment as a whole are also evaluated, and the modifications expected to be made during construction are defined; this influences the evaluation of the complexity of the geological and engineering conditions of competing areas, and this, in turn, determines the selection of the best alternatives in construction sites, routes, etc.

The type of forecast under discussion is one of the most widely used. In the Department of Permafrost Studies, Moscow University there is an accumulation of 20 years' experience in compiling local forecasts for the various needs of the national economy (hydrotechnology, industry, transport related construction, extraction of scattered deposits, etc.), at various stages of research in different permafrost regions; this has allowed the principles of geocryological forecasting to be worked out during geological engineering research, and for its structure and content at the various stages of investigation and planning to be determined.

Objects of the Forecast

All the individual characteristics of the geocryological conditions are objects of the forecast. This includes changes in distribution, mode of occurrence, composition and structure; probability of thawing and reformation; dynamics of the temperature regime and depth of seasonal freezing and thawing; probability of permafrost formation, occurrence of cryogenic processes and phenomena; changes in composition and characteristics of frozen, freezing, and thawing ground, and in the geological engineering conditions. The most essential objects are: type of change in "cryogenic texture"* water-confining strata in permafrost; catchment and discharge areas; and changes in the flow conditions of subsurface water, its chemistry, supply and resources. In this case, when individual components of the conditions are forecast, for example, the temperature regime of the earth materials or the thermal interaction of structures and underlying permafrost, it should be called a partial forecast. A full forecast gives the characteristic changes of different types of seasonal and perennial freezing and of the cryogenic processes. Obviously a

* Texture characteristic of frozen fine grained and organic mineral earth materials cemented together with ice.

full forecast automatically solves the problem of partial forecasts, or lays the groundwork for its solution. A geocryological survey allows the possibility of compiling this type of composite forecast. Inclusion of the history and development of the permafrost must be fundamental to the forecast when determining the nature of change in the conditions as a whole, and of each object individually. As already pointed out, the history of its formation, and the present day dynamics of the conditions are manifest in the general background, against which, all changes in the conditions associated with the natural development of the environment and with the economic development of the area take place. Therefore, the forecasting of the natural course of development of the conditions expected in the near future is one of the main objects of the forecast.

In local forecast, the technical objects are a major concern. These objects include: forecasting of the thermal interaction between a structure and the permafrost; the nature of changes in the latter as a result of heat loss under buildings and structures; the possible thawing of the frozen foundations; determination of the thaw basin; forecasting of changes in composition and characteristics of frozen, thawing, and freezing ground; and the determination of their mechanical, rheological, and deformation characteristics under load, etc. Of no less importance is the forecasting of the genesis and mode of occurrence of such cryogenic processes and phenomena as thermokarst and thermal abrasion, frost heave, solifluction, icings, fissure formation, creep, slump, cave-ins, etc.

It is common knowledge that all geocryological features are interrelated and, therefore, so are the objects of the forecasts. The forecast of a change in one of these objects inevitably reflects occurrence of change in the other objects. Therefore, the forecast of a change in one geocryological feature must be taken into consideration and related to the general forecast for a given region. Such interaction between the objects permits a correct approach to the methodology of forecasting.

Forecasting Methods

Method for rough qualitative evaluations. In order to obtain a general, preliminary concept of anticipated changes in geocryological

conditions during economic development of permafrost terrain, it is usual to draw on existing literature and cadastral data on the area. In this case, it is usually possible to make a qualitative evaluation of anticipated changes and to proceed with dividing the area into regions. Either, regions can be designated where the conditions seem least resistant, where permafrost thaws as a result of economic development or forms again with a sharp change in its characteristics and frequent occurrence of the cryogenic processes and phenomena, or they can be designated where changes only affect individual permafrost features without causing it to thaw. Such a method, based on the most general considerations can be called a rough method.

The method of recording experience in construction and economic development in an area is based on accumulated information on construction experience in permafrost areas. Depending on local conditions, the most rational principles and methods of both construction and other aspects of economic development, are determined on the basis of a detailed analysis of construction experience and causes of deformation of buildings and structures.

The method produces good results when used in conjunction with other methods (surveying, assessment, permanent sites, etc.), for this allows the possibility of disclosing the general interactions of structures and the environment, of restoring the original conditions and of linking these changes to changes in the environment and the influence of technical factors. One of these methods, which is being used independently, is descriptive, and is restricted to communication and dissemination of existing experience to other regions.

Methods on experimental sites which are specially equipped for experimental work are related to the preceding method - the study of construction experience and economic development of permafrost terrain. The method has great possibilities. The selection of a permanent research program and the placing of sites must be done in such a way so that they are situated in typical and "plakory"* conditions of the region being developed.

* Slightly undulating, well drained interfluves (Transl.).

On these sites, preliminary studies can be made of both general and individual patterns of permafrost formation and development under given natural conditions, and the role and nature of the geocryological factors can be determined. Forecasting assessments can be worked out, tested and corrected on these sites. The disadvantage of this method is the limited choice of sites and combinations of environmental conditions existing on given sites. However, in this case, the selection of technical factors is not restricted. The present method of studying conditions and compiling forecasts can be of great importance if it is considered in conjunction with other methods, especially the geocryological surveying method, by taking into account construction experience and assessment methods.

The method of assessment is an integral part of the environmental-historical and ecological forecast and the technical forecast alike, when making general, regional and local forecasts. Assessment methods guarantee the quantitative evaluation of those changes in conditions arising from the economic development of a permafrost area. Assessment methods permit the calculation of changes in the radiation balance of the earth's surface, changes of heat exchange between the atmosphere, the soil and the underlying permafrost, and those changes in conditions which follow the economic development of a region. The assessment methods allow the possibility of a quantitative assessment of the role of each geocryological factor in both the natural and changed states, and can reveal the quantitative aspect of general and individual formation patterns of permafrost and of the geocryological conditions in their entirety. The same must be said with regard to the technical factors. At the same time, it must also be pointed out that, when resolving the problems of local forecasting, and when using analog and digital computers, it is essential not to select only those conditions which were prevalent at the time of the research survey: forecast changes in conditions must be taken into consideration. In this way, the use of assessment methods must necessarily be considered in conjunction with other methods of forecasting and, above all, with the geocryological survey.

The geocryological survey method forms the basis for the most complete, detailed forecast. This is because the given method is the most

complex. When making a survey, use is made of construction experience, experimental sites, organization of the observations made over many years and of experimental construction; of all field, assessment methods, express methods and, during the laboratory period, of computer methods. This allows the researcher to make a direct, quantitative assessment in the field and, in the laboratory, to evaluate the influence of various environmental and technical factors on the formation of various geocryological features and their changes associated with construction and economic development. The most valuable feature is, that during the survey, a most comprehensive study can be made of these relationships. This allows the possibility of assessing their occurrence in the greatest variety of environmental conditions. Connected with this is the possibility of assessing anticipated technical changes.

At the same time, geocryological surveying has called for the quantitative assessment and determination of those initial data which must be compiled, when solving problems associated with the local forecasting of the thermal interaction of various structures with the permafrost. A geocryological survey guarantees the collection of material necessary for compiling a map showing both the general character and forecast changes. Geocryological maps are the most communicative form of information on the conditions in the area being developed, making it possible to solve geocryological problems for any part of the researched terrain. Therefore, as the forecast is the final stage of a geocryological survey, it is the most involved and complete, since it forecasts a complex change in the conditions. This forecast is partly environmental historical and partly technical.

Forecast Content

The enumerated forecasting methods allow the possibility not only of forecasting anticipated changes in the geocryological conditions related to construction and economic development in an area, but also of establishing the principles and methods for modification of the geocryological processes, with a view to establishing optimum working and environmental conditions. Drawing on the knowledge of formation patterns of the geocryological conditions, it is possible to speak of the measures that must be taken to

attain this goal. Each measure, whether it is a change in character of the cover (snow, vegetation); a change in the composition of earth materials resulting from heaping of earth, site preparation, or excavation of earth materials; draining or flooding; building; laying of asphalt; construction of reservoirs; etc. can be evaluated quantitatively or qualitatively. By selecting appropriate measures, depending on existing conditions and the technical needs for construction and development, optimum conditions for development can be created. This can be accomplished for each local project, even when environmental and geocryological conditions over a vast area are being modified. This results in a three part geocryological forecast determining: 1) anticipated changes in geocryological conditions; 2) principles and methods of modification to be made to the conditions and those already brought about; 3) principles and methods of environmental protection in permafrost terrain.

The question examined bear evidence of the complexity of the problem and of its great importance for the national economy.

GEOCRYOLOGICAL SURVEY METHODS

V.A. Kudryavtsev and K.A. Kondrat'eva
Department of Geology, Moscow State University, U.S.S.R.

The basic positions on procedures and methods in geocryological research have been formulated by the leading geocryological organizations: The Obruchev Permafrost Institute, Academy of Sciences of the U.S.S.R.; Moscow State University; Department of Geocryological Research, Industrial and Research Institute for Engineering Surveys in Construction, State Committee on Construction (Gosstroi SSSR); the Permafrost Institute, Siberian Division, Academy of Sciences of the U.S.S.R.; the All-Union Research Institute of Hydrogeology and Engineering Geology, Moscow, U.S.S.R., etc.

However, the extensive development of the permafrost region, which called for intensification of geocryological research that is now being carried out on various scales and for different purposes, necessitates further elaboration of the state of geocryological surveying and of the basis and implementation of both the permafrost research methods employed earlier and those which are again being implemented. Work on methodological questions in progress in the Department of Permafrost Studies, Faculty of Geology, Moscow State University is directed towards improving the quality, acceptance, and cost effectiveness of geocryological surveying, and towards rational use of its results in the development of agriculture, for protection of the environment and for scientific understanding of the permafrost region of our planet, with a view to controlling the cryogenic progresses.

Specialized research on the permafrost region can proceed in the form of geocryological surveying and as a statement of individual types of geocryological observations. In the latter case, this can be the accumulation of information on some individual characteristics of the

kriolithozone such as: the distribution of permafrost or temperatures of earth materials; the ice content and cryogenic textures of deposits, etc. Even when information on several characteristics is obtained, such research which records existing geocryological conditions cannot give a geocryological and geological engineering evaluation of the area, and serves rather to compile a forecast of change in geocryological conditions in connection with some construction project or with some other aspect of development.

If these questions are to be answered when studying a permafrost region, not only must the existing conditions be determined, but there must also be an explanation as to why these conditions exist, what determines their existence, which natural conditions and factors influence their formation, and how they will develop as a result of changes in the latter. Consequently, geocryological research must necessarily include a study of patterns of the formation of geocryological conditions, both because of the influence of each environmental factor and their local effect.

The quantitative analysis of this influence, together with qualitative analysis, which is carried out by computation methods and correlates the thermophysical and geological-geographical nature of seasonally and perennially frozen materials, is called factor analysis. Only when this type of methodological approach to geocryological surveying is employed can a forecast of change in permafrost conditions be worked out on the basis of its results; and this is the obligatory final stage of a survey, whatever the scale.

A geocryological survey is a combination of field and laboratory research projects having as their aim the study of individual and general patterns of formation and development of seasonally and perennially frozen materials, and their associated cryogenic processes and formations, from which an overall picture of the geocryological conditions of the terrain can be derived. Therefore, as a result of a geocryological survey, the following should be studied:

- 1) distribution patterns of seasonally and perennially frozen materials, and the sporadic nature of their spatial distribution, depending on changes in the geological and geographical environment;

2) bedding conditions and stages of permafrost throughout the section, depending on the dynamics of the climate, geological structure, neotectonics, and influence of surface and groundwaters;

3) characteristics of the composition and properties of frozen, freezing, and thawing materials and of geologic-genetic complexes and formations;

4) characteristics of the cryogenic structure of permafrost, and of the cryogenic structures, moisture and ice content of unconsolidated materials and the bedrock, depending on composition, genesis, age and neotectonic development, type of freezing, and the dynamics of development of the cryogenic process;

5) patterns of formation of the temperature regime of materials at the bottom of the layer of seasonal freezing and thawing and at the depth of zero annual amplitude, on the basis of the factor analysis of existing natural conditions and the dynamics of their development in time;

6) patterns of formation of depths of seasonal freezing and thawing of materials, and their dynamics, depending on changes in environmental factors;

7) characteristics of changes in depths of seasonally and perennially frozen materials in time, both in spatial distribution and within the section, due to the geocryological historical development of the region and the existing natural conditions;

8) characteristics of formation and development of various types of taliks, depending on the genesis, distribution and nature of their occurrences;

9) patterns of development and distribution of cryogenic and other geological processes and formations, depending on the combination of natural conditions;

10) characteristics of the interaction of permafrost and surface and groundwater depending on existing natural conditions and the history of the cryogenesis;

11) peculiarities of the geological engineering, and evaluation of seasonal and perennial freezing of materials, depending on the direction of agricultural development of the terrain:

12) construction experience and effects of other aspects of development, depending on the type of engineering projects and the dynamics of the cryogenic process;

13) history of permafrost development, depending on the dynamics of the climate and the geological history of the region.

Thus, the geocryological survey is the basic form of research into seasonally and perennially frozen materials, since it solves a wide range of scientific and industrial questions and includes as integral parts, all other lines of research into the geocryological conditions.

The formation and development of seasonally and perennially frozen materials is a concrete expression of the general laws of the development of matter as applicable to the geological forms of its progression, seen from the Marxist-Leninist position on the theory of knowledge. The basic positions of geocryological surveying are based on these laws which are formulated in the following way by V.A. Kudryavtsev in "Fundamentals of permafrost forecasting in engineering geology surveying".

1. In nature, there is a universal connection between phenomena and processes, which determines the interdependence of geocryological conditions and all environmental factors.

2. In nature, there is uninterrupted evolution in time and space of the components of which it is composed, in accordance with which, the formation and evolution of seasonally and perennially frozen materials take place.

3. In nature, all phenomena and processes are linked by cause, and therefore it is essential to study causes and conditions of the formation of geocryological conditions dependent on environmental factors and changes in combinations of these factors in time and space.

4. In nature, there is a constant transition from quantity to quality which, with respect to permafrost, is manifest in the transition of temperatures through 0°C and which determines the new characteristics of the frozen or rethawed materials.

5. In nature, matter is primordial; therefore, the material composition and the cryogenic structure of seasonally and perennially frozen materials characterized by these or other permafrost characteristics must be the fundamental object of research.

6. The study of natural conditions must be conducted from the position of unity of analysis and synthesis, i.e., the study of the patterns of formation and development of geocryological conditions has to be based on factor analysis; this allows the study of particular (bilateral) dependencies of each of the geocryological characteristics on each factor of the environment, and on the generalization, the synthesis of all particular dependencies manifest in the form of general patterns of landscape type.

7. The results and scientific generalizations of data from the geocryological survey in the form of geocryological maps of existing and forecast conditions, of a geocryological forecast, and of recommendations for the control of the cryogenic process are verified by subsequent, more detailed studies or field work, which are the criteria for truth.

Geocryological survey methods. The basis of the geocryological survey is the topographic key method. In essence, this consists of the optimum division of the required volume of research into individual small units "keys", in order to obtain the most reliable results for all areas being surveyed. Designated regions, typical both of the characteristic, widely distributed environmental conditions, and of the areas where they occur abnormally, can be used as keys. The selection of keys is conducted on

the basis of the study of previously collected factual material, the deciphering of aerial photographs, aerovisual research and topographical microregionalization, when the latter is done on the scale of a survey. When landscape microregionalization is conducted to scale, regions having identical geological and geographical conditions can be typified, and physical regions having uniform geocryological conditions can be identified. Key regions, depending on the purpose and the scale of the survey, can embrace one or more landscape types. For an average or detailed survey, research conducted in the key regions is 5-10 times more detailed than in the rest of the territory.

The basic type of research carried out in the key regions is the study of individual and general patterns of formation of geocryological conditions, with the aid of a wide combination of types of research and methods. Distribution of established patterns throughout an area is ascertained by microregionalization and the analysis of changes in combinations of natural conditions from one region to another. Such an approach determines the possibility of studying the dynamics of the geocryological conditions, both as a function of the natural environment and with regard to industrial development of the territory.

The special geocryological methods used in the remaining types of research in the key regions and corridors are:

1. Factor analysis, which is fundamental to the study of individual and general patterns of formation of mean annual temperatures of earth materials, depths of seasonal freezing and thawing, development of cryogenic processes and phenomena, etc.

2. Permafrost facies analysis which is used in the study of syngenetic permafrost in outcrops and mining excavations, when conditions of accumulation and freezing can be assessed from the type of cryogenic structure and by the relationship of the intercalations and ice streaks to the ice content of the materials. In this case, the cryogenic structure is the generic manifestation of permafrost.

3. Geological structural analysis, which reveals the essence of the interrelations of the composition, the condition and characteristics of the materials, the distribution patterns within the massive structure, depending on the historical development (especially recent development) commensurate with the cryogenic age of the permafrost.

4. Topographical-geomorphological analysis, used in the study of regional patterns of formation of geocryological conditions.

Special geocryological methods are used in combination with such methods as: 1) visual study of geological, geomorphological, geobotanical and other geological processes and formations in the key regions corridors, survey flights over the terrain; 2) in the deciphering of aerial photographs; 3) thermal radiation balance and thermal overturn of the ground; 4) borings and other mining excavations; 5) geophysical research methods: electrometric, radiowave, seismic, and complex carotase of boreholes; 6) thermometric study of the thermal regime; 7) approximate calculations and simulation by computer of the cryogenic processes of the temperature field of the permafrost, depending on changes in the combination of natural conditions; 8) experimental, permanent research of the condition and characteristics of the permafrost; 9) study of construction experience and other types of development, etc.

The scale of geocryological surveys and maps is determined by those problems which arise at various stages of expansion of the economy and development of the territory being studied. The main content of a survey on any scale is the study of individual and general patterns of formation of geocryological conditions, based on factor analysis. The amount of detail in such a study is determined by the scale of the survey.

The scales of the geological surveys, by analogy with the divisions accepted by the S.E.V. for engineering and geological surveys (1966) are as follows:

small scale	- 1 : 100,000	- 1 : 500,000
medium scale	- 1 : 25,000	- 1 : 50,000
large scale	- 1 : 10,000	- 1 : 5,000
detailed	- 1 : 2,000	and larger

Geocryological research at a scale 1 : 2,000 or greater is highly specialized, specific, and is aimed at a study of the geocryological and engineering characteristics used in the planning stages of the physical aspects of construction.

Geocryological research on the scale 1 : 1,000,000 or less is based on aerial photography, by the assembling and generalizing of materials from previous geocryological, geological engineering and other types of research, and their analysis by factor and computational analysis with a view to compiling geocryological maps. The territories surveyed are used as "key" regions and provinces.

The study and establishing of general and regional patterns during this process must draw on the knowledge of the regional geocryological background; research papers, geocryological maps of a smaller scale than that of the survey can serve in this capacity. The following should be used for regional background:

a) for average and large scale surveys - those geocryological conditions and patterns which are reflected on the small scale maps (1 : 200,000 - 1 : 500,000);

b) for small scale surveys and mapping - zonal-regional geocryological conditions and their corresponding patterns and formations, which, for the area under study, are reflected in the geocryological maps on the scale 1 : 1,000,000 - 1 : 5,000,000.

The Geocryological Map of the U.S.S.R. (1 : 2,500,000) would provide the most relevant information; this was compiled in the Department of Permafrost Studies, Moscow University, in conjunction with a number of other organizations. This map, which is based on factor analysis of the influence of the environment within isolated geological and geomorphological and landscape units, allows the basic phenomena of geocryological patterns to be worked out, and the combination of all the factors forming a permafrost region and their respective roles to be clarified, prior to field work. This sort of opportunity is extremely important for small scale geocryological

surveys as the presence of an assemblage of materials from aerial surveys (general planning, coloured, spectrozonal, space) and from infra-red surveys increases the role of preliminary laboratory work. This radically changes the structure and relationships of the stages of the survey.

Even in the case of regions for which no assemblage of aerial photographs has yet been established, and for which there is a limited amount of data on seasonal and perennial freezing of materials, average and small scale geological surveys can be conducted at an increased pace, as a result of the new approach. The latter is based on the compilation of preliminary geocryological support maps, which are subsequently tested and refined during field work. When this approach is used, research is directed towards a more detailed and well-grounded study of the natural factors and of their role in forming the geocryological conditions, and towards the study of the cryogenic processes and the role of changes observed in the environment when a region is developed. Such an approach contributes to the detailed soundness of the groundwork in the compilation of a regional geocryological forecast. In this case, the undertaking of a survey becomes more purposeful and scientifically more profound. Accordingly, the role of specialized key regions increases considerably. In these regions pragmatic aspects are solved by studying the individual and general patterns of formation of geocryological and geological engineering features of the earth materials, right up to the commencement of experimental and routine work.

Quality of Geocryological Surveys and Maps. Due mainly to the obligatory use of factor analysis to establish individual, general, and regional patterns of the formation both of seasonal and perennial freezing of materials and of the cryogenic processes and phenomena being studied by the landscape-key method, a high quality is achieved and specification standards for geocryological surveys are met - other conditions being equal. The above shows that a geocryological survey must be conducted at the current level of knowledge of geocryology. This includes the mastering of the most advanced current theoretical work in world geocryological thought; the mastering of up-to-date regional and thematic geocryological materials; a high degree of professionalism of the specialists conducting the survey; an ability to generalize the results obtained; knowledge and application of up-to-date methods and research techniques; and mandatory skill in factor analysis.

The up-to-date level of knowledge in the various disciplines presupposes the quality of all stages of research. In conformity with the study of the permafrost region, the quality of the geocryological surveys and maps is established in the following stages:

a) by compiling a program based on up-to-date methods guaranteeing the soundness and quality of the survey and mapping;

b) a preliminary period of study prior to field work; and a period of purposeful generalization of available geocryological, geomorphological, geological and other practical material and the working out of preliminary concepts as exactly as possible, for the understanding of individual general and regional patterns of the terrain. To this period belongs the compilation of preliminary maps, geocryological maps of a supportive nature, i.e., compiled in such a way that, both by the amount of detail and by the content, they meet the requirements of the maps being compiled as the final stage of the permafrost survey. The most vital condition for effective compilation is the obligatory aerovisual inspection of the terrain and the analysis of its natural features, drawing on black and white, coloured, spectrozonal and space aerophotographs.

c) during field work, refinement of individual and general patterns previously established during processing of factual material and compilation of preliminary (support) geocryological maps. As the geocryological conditions being studied in the field and those previously mapped coincide and are refined, it becomes considerably easier to isolate individual topics requiring detailed field study.

d) during the laboratory period of verification and development of those geocryological maps reflecting the natural conditions, compilation of general, regional and local forecasts and corresponding forecast maps.

The high quality of geocryological surveys is closely associated with their meeting the specifications, since this determines, not only the number of survey points (borings, pits, thermometric measurements, etc.), but also the reliability of the results of the research, from the position of

factor analysis. When a survey based on the landscape-key method is conducted without factor analysis, since only the correspondence between determined geocryological conditions and each local landscape type is established, patterns of formation and the role of each factor remain concealed, and the survey cannot be considered of high quality or up to standard.

Only when a survey is conducted on the basis of the landscape-key method and factor analysis of patterns of formation of geocryological conditions is it guaranteed to meet the required standard, and can it allow for the possibility of compiling well-grounded geocryological forecasts and forecasting maps, and can the scientific information on geocryological conditions and patterns of their development correspond to the present-day level of theoretical and regional achievements of geocryological knowledge.

Geocryological maps are the basic documents of the geocryological survey and are based on the principles of genetic classification of seasonally and perennially frozen materials. The content of these maps is determined by the approach to their compilations, onto which, a factor analysis of geocryological analysis is superimposed. Such an analysis is conducted in each landscape micro-regionalization unit with regard to climatic features, geobotanical, geomorphological and other geographical conditions of heat exchange on the earth's surface, and on geological, hydrogeological, geothermic and other conditions determining the character of heat exchange in the earth materials. All geocryological maps are compiled on geological and geomorphological bases and must show the composition, genesis, stratigraphical affiliation and conditions of bedding of seasonally and perennially frozen materials.

The basic method of indicating geocryological conditions on maps is the individual depiction of fundamental geocryological characteristics and conditions of the environment. Such an approach not only permits acquisition of information from the map on some parameter or other of permafrost and on their changes through the terrain, but also comprehension of the combination of factors which brought about these geocryological conditions in a given mapped region.

The accuracy of mapping combinations of natural factors fundamental to the landscape microregionalization is determined by the accuracy of the division of relief features isolated in accordance with landscape conditions on the topographical maps of the appropriate scale and on space and aerial photographs.

The accuracy of mapping geocryological characteristics is determined by studying the terrain with a view to establishing individual and general patterns of formation of the geocryological conditions, and by the reliability analysis based on the landscape units. It must be borne in mind that gradation of geocryological characteristics on a map of larger scale need not be less precise than those of the corresponding zonal-regional conditions on the "Geocryological Map of the U.S.S.R.", scale 1 : 2,500,000.

A geocryological map can be compiled in the form of two complementary maps: a map of seasonally and perennially frozen materials, reflecting the distribution patterns over the terrain manifesting the basic classification characteristics of these materials and of the conditions of heat exchange at the surface; and a permafrost map reflecting basic, geological, genetic types of permafrost formations and their geocryological characteristics. The intensity of mapping on a permafrost map is determined by the depth of the permafrost and the materials containing brine cooled to below 0°C, and by the conditions of heat exchange at this depth.

On detailed geocryological maps, the following must be indicated in accordance with the survey scale: 1) distribution of seasonal and perennial freezing, 2) distribution of geological-genetic complexes, 3) the composition, bedding and characteristics of frozen and thawed materials of the various genetic and stratigraphic affiliations, 4) mean annual temperature of the materials, 5) depth of seasonal and perennial freezing and their sporadic occurrence in the vertical due to the presence of deep, relic permafrost horizons, 6) materials with sub-zero brine (kriopegs), 7) cryogenic structure and ice content of permafrost throughout the section and its spatial distribution, 8) cryogenic processes and formations, 9) taliks, 10) cryogenetic type of permafrost throughout the section and their spatial distribution (syn-, epi-, and poly-genetic) and other out-of-scale characteristics of seasonally and perennially frozen materials.

Geocryological sections are appended to the maps; these indicate geological structure, composition and bedding conditions of the permafrost throughout the section, and their spatial distribution, the temperature regime, the moisture and ice content throughout the section, confined to the geological-genetic types and formations of the earth materials, the type of freezing, etc. Integral to the map are the graphics for computation. These consist of the mean annual temperatures of the materials and depths of seasonal freezing and thawing in accordance with basic reference data indicated on the map, and a table of the results of factor analysis, on which the map is based. On geocryological maps, the basic methods are used to depict the main characteristics of the geocryological conditions.

Compilation of geocryological maps begins with the compilation of a preliminary map prior to field work. This increases considerably the role of the forecasting factor analysis, i.e., that which is directed at forecasting patterns of formation of geocryological conditions, etc., for every region being mapped.

For this, factual material on the geology, geomorphology, hydrogeology, climatic and geocryological conditions, etc., are analysed from the standpoint of the formation of geocryological conditions, and on this basis, the map's legend is compiled tied in with the regional geocryological background. Calculations according to the most exact formulae and with constant comparison with available and somewhat numerous factual data on seasonally and perennially frozen materials allow the possibility of formulating an idea of the patterns of formation of the mean annual temperature, the depth of seasonal freezing and thawing, the depth of the permafrost, the development of the cryogenic processes, etc., throughout the terrain being researched.

The correctness, speed, and accuracy of mapping are considerably improved by the use of materials from an aerial survey, because these give the details and indications of the composition, state, and processes of the permafrost which is not usually given in preliminary direct mapping topography of even larger scales. A special role is played by space photographs at a scale 1 : 500,000 - 1 : 200,000 which, because of the low

resolution, can distinguish internal regional components of the Earth's crust and their associated geocryological and hydrogeocryological patterns.

Geocryological maps compiled for the survey period must contain initial data for the compilation both of forecast changes in geocryological conditions and of forecast maps. In this regard, special attention is paid to showing the distribution of permafrost and its temperature regime, since the mean annual temperatures of the materials revealing the total influence of the present-day environment through a large number of factors, variable in space and time, are easily calculated by accurate formulae both for existing conditions and those being forecast ("Fundamentals of Permafrost Forecasting...", 1974) or by the simulation of the heat exchange conditions in the annual cycle of an analog computer or by programming of a high speed computer.

Scientifically based and economically viable expedient recommendations for measures concerning control of the cryogenic process can only be formulated on the basis of the geocryological forecast. The distribution throughout the area of the results of the forecast is carried out with the help of geocryological forecast maps, which are compiled for such environmental (including geocryological) conditions as these are sustained in the area being researched during the forecasting period, as a result both of the natural evolution of the environment and of man's economic activity.

The compilation of geocryological forecast maps is accomplished on the basis of factor analysis, for in this case alone, there is analysis and determination of the influence not of those natural factors existing during the survey period, but of the changes sustained in the given area during the forecasting period. A table is appended to the forecasting maps; this indicates, for the whole region, measures which would assist in improving geocryological conditions and in averting the growth of unfavourable cryogenic processes.

In conclusion, it should be noted that forecast maps on a small scale reflect the orienting, regional, geocryological forecast for large areas; those on a large scale reflect the detailed forecast for local engineering projects.

ELECTRICAL STATE OF A PERMAFROST CROSS SECTION

V.I. Mel'nikov and B.I. Gennadinik
Permafrost Institute, Yakutsk, U.S.S.R.

The layer of seasonal temperature fluctuations in the permafrost is the layer in which the physico-chemical processes associated with energy exchange between the Earth and its surrounding space are the most intense. Transformations occurring within it, brought about by these processes during the annual cycle, are mainly assessed by change in their thermal state, using the methods of geothermy (Dostovalov, Kudryavtsev, 1967). However, the latter give too general a picture of the profile. Therefore, we have recently been more and more attracted by the methods of electrophysics, since the technical possibilities are greater than those of geothermy (variety of methods of excitation and recording of the electromagnetic field, range and amount of change of the parameters being studied, accuracy of measurement).

The object of electrophysical research of permafrost is the earth materials as a geological formation, from the point of view of electrical interaction.

The aim of the research is the study of the state of earth materials in permafrost conditions. A feature of electrophysics is that a geological section can be assessed by the state of the electromagnetic field.

This research deals with the characteristics of interaction between the electromagnetic field and the earth materials. A set of parameters of the electromagnetic field which reflect the state of the section under given conditions and at a specific point in time can be called the electrical state of the geological section. In other words, the subject

of research is the establishment of patterns of change of the electrical state of the geological cross section in time and space.

The structure of the subject of research is shown in Figure 1.

Figure 1

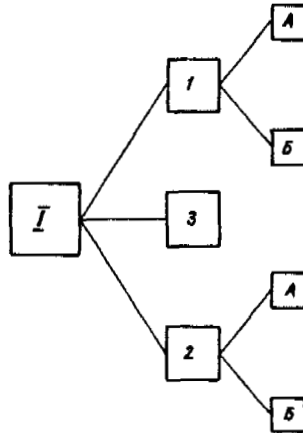

- Electrical state of the geological section:
- 1 - state of the geological object (A - internal parameters, B - external conditions);
 - 2 - state of the electromagnetic field (A - internal characteristics, B - external conditions);
 - 3 - physico-chemical processes.

Factors determining the internal state of the geological object (Figure 2):

1. Geological - determine the structure of the section and possible grounds for its change.
2. Physical - include the phase composition and the spatial relationships of the phases. The phase structure determines;
 - a) type, mobility and quantity of current carriers;
 - b) mechanism and nature of polarization without current;
 - c) possibilities of change in state of the materials with change in external conditions (liquid phase can be found in metastable state or can change into solid phase).

Figure 2

State of geological object.

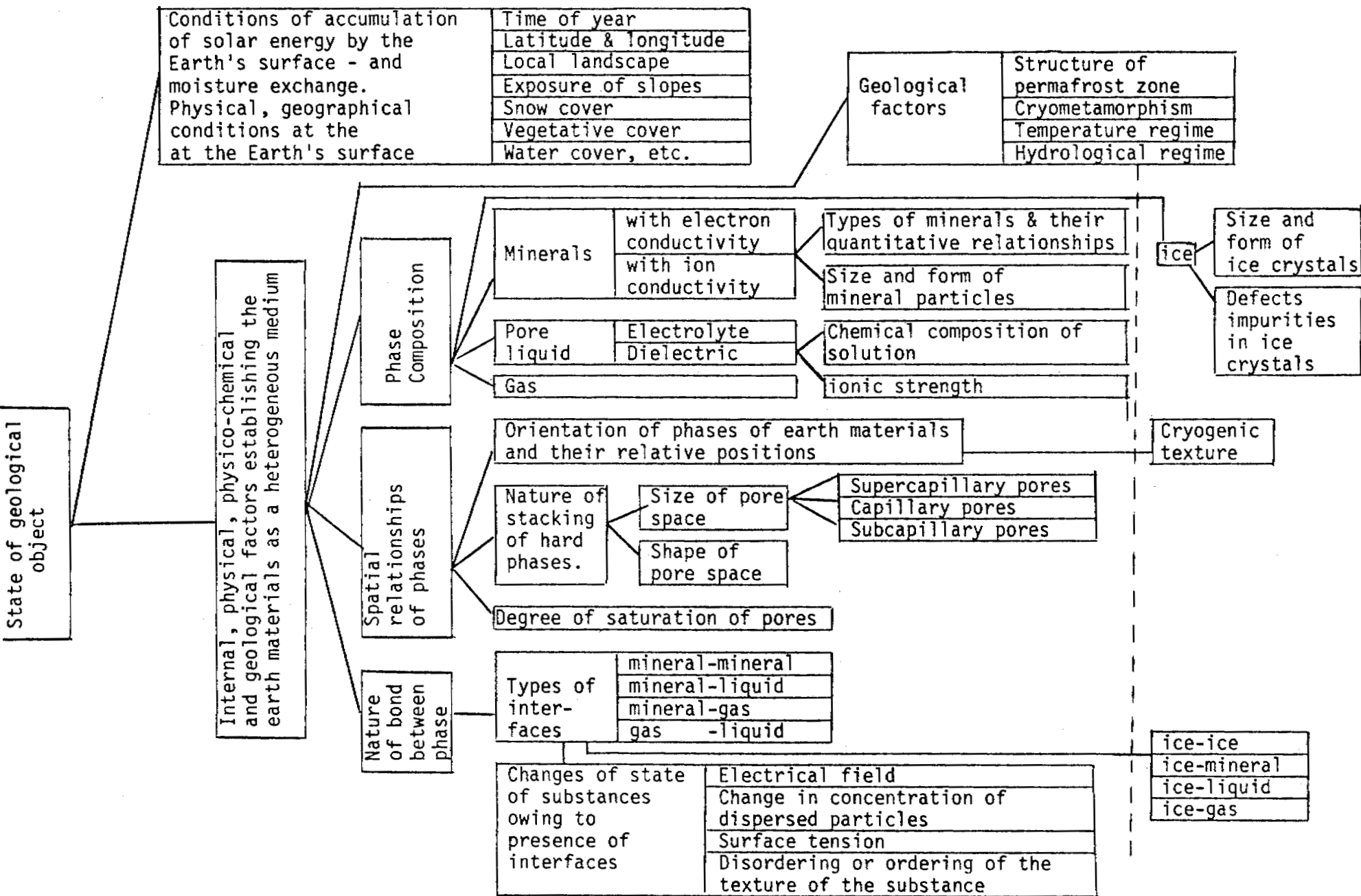

ice

- Size and form of ice crystals
- Defects impurities in ice crystals

Cryogenic texture

- ice-ice
- ice-mineral
- ice-liquid
- ice-gas

In permafrost, materials are found (permanently or temporarily) in conditions where water is manifest in three states: solid, liquid or gaseous.

The spatial relationship of these phases determines:

- a) distribution of the carriers in the materials and the possibilities of their unimpeded dislocation;
 - b) polarization of the materials as a heterogeneous medium.
3. Physico-chemical - includes the nature of the bond between the phases and determines:
- a) heterogeneity of the substance;
 - b) nature of distribution of carriers within them;
 - c) mechanism of phase transitions;
 - d) possibility of carriers crossing the boundary of the interface of phases.

Consideration of the physical and physico-chemical parameters (Mel'nikov, 1977) show that:

1. Semiconductors have the highest electrical conductivity but, being accessory minerals, they have little influence on the electrophysical parameters of the materials.
2. A solution of electrolyte, even when present in a small quantity in the materials, will, as a rule, determine their electrophysical properties, since it forms a complete system of current carrying channels and is characterized by a high permittivity and, when there is a change in conditions, is capable of changing the composition and nature of distribution within the materials.

3. The substance of the mineral-dielectrics determining the petrographic composition of the materials has little influence on their electrophysical parameters.

Therefore, the electrophysical parameters of the materials are determined by:

1. The size and structure of the pore space;
 - a) porosity;
 - b) penetrability and degree of tortuosity of the communicating pores;
 - c) specific surface and roughness of surface of the pores;
 - d) average size of pores and density of distribution of the pores throughout the section;
 - e) type of section and degree of consistency of the pores throughout the length;
 - f) frequency of intersection of pores of differing orientation.
2. Saturation of the materials.
3. Ionic strength of the solution filling the pore space.

The mineral composition and the composition of the solution influences the electrophysical parameters of the materials only to the extent that it determines the interaction of the solid and liquid phases.

Solid rock has the most stable characteristics; in unconsolidated materials, they are somewhat dependent on the moisture. The least stable are those of permafrost, since not only are they determined by the texture of the primary earth materials, but also by the textural characteristics of the ice cement.

When materials freeze, their porosity, average section and dispersion of pores in the section decrease; there is an increase in the tortuosity of the pores, their consistency throughout the length, specific

surface and concentration of electrolyte in the liquid filling the pores; while there is a simultaneous reduction in the overall quantity of the carriers. Heterogeneous, opposite surfaces appear in the pores, which leads to redistribution of the various types of carriers. In the microtextural sense, the materials become more homogeneous but the geological section becomes less homogeneous, due to the wide development of intercalations and ice inclusions, and their distribution becomes uneven (polygonal structures) and frequently even anisotropic (when there is a predominant orientation in their distribution, these are layered structures). Anisotropy of the section is also brought about by large gradients in moisture, temperature and concentration of soluble salts in the active layer.

In electrophysics, the parameters measured are those which characterize the state of the electromagnetic field (Figure 3). It is possible to divide it (conditionally) into natural and artificial, according to its origin.

A natural field can be connected with:

- a) processes occurring in the materials behaving as a heterogeneous medium in a state of equilibrium (jump of potential at the interface of phases, Dannon's potentials), in this case there are no macrocurrents, polarization can only be assessed when the equilibrium has been disturbed during measurement;
- b) processes occurring under steady conditions when currents are being maintained by invariable external conditions, leading to a constant separation of charges (fixed polarization-filtration, diffusion, and thermo-diffusion potentials) and to the presence of a steady current with no sources in the volume being investigated;
- c) directional change of state when a through current and a time varying polarization exists simultaneously, and their separation becomes conditional upon the degree of averaging of the medium.

Figure 3

State of electromagnetic field.

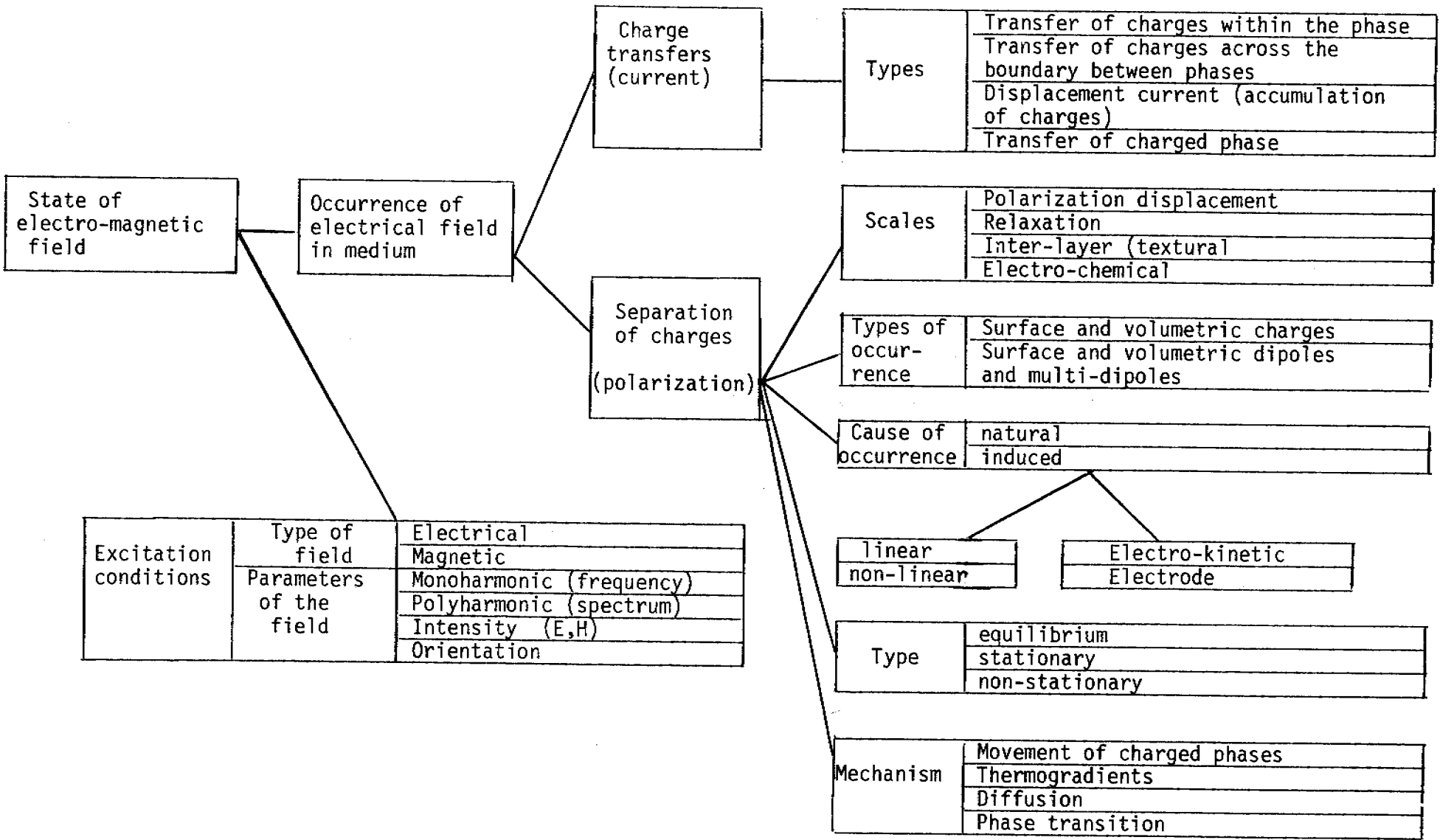

A special place is occupied by electrical polarization associated with phase transitions determined by the diverse capture of different types of ions from the solution, by the growing crystal lattice (Mel'nikov, 1969), by their redistribution both in the liquid phase of the pore space and at the interface of the phases (disturbance of the adsorption equilibrium during a change in the concentration of ions).

Induced electrical phenomena, studied by electrophysics, occur, as a rule, under the influence of the external electromagnetic field on the medium; the field is determined by the given conditions of excitation appearing in the form of:

1. Macroscopy electric current and its related polarization.
Its intensity and nature of distribution in the volume being studied are determined by;
 - a) the capacity of charged particles for dislocation within individual phases (by type, quantity and mobility of the carriers);
 - b) characteristics of the crossing over of carriers at the interface of phases;
 - c) by relaxation processes.

Polarization is conditioned by the following causes:

- a) in the region of the interface of phases having a different number (or different mobility) of carriers, their concentration varies, and this leads to the occurrence of a surface charge, away from which a local field evens out normal current densities towards the surface within the phases (capacitive polarization);
- b) in a region of sharp depletion of basic carriers or at the interface of phases with a different type of conductivity, there is a jump of potential corres-

ponding to the presence of a double electric layer (electrode polarization). In this case, the number of separate charges is 3 - 10 orders of magnitude greater than in the case of capacitive polarization (Gennadinik et al., 1976);

- c) if even in only one of the interface phases a transfer is realized by two or more carriers, and the transport number of these carriers also changes, then an electrically neutral region of change in carrier concentration arises near the surface (diffusion region in the electrolyte solution, a quasineutral region in the extrinsic semiconductors, a region of joining of current - conducting channels with different transport numbers); change in concentration of carriers leads to their diffusion and, in the presence of uneven diffusion currents of various types of particles, separation of charges and electrical polarization associated with the electrokinetic processes occurs.

- 2. Polarization without current, determined by polarizations of dislocation (relaxation and textural) (Parkhomenko, 1965).

The state of the electromagnetic field is determined by the physico-chemical processes occurring in the materials (Figure 4), and reflects the state of the geological section (Gennadinik et al., 1976; Mel'nikov, 1977).

These processes can be basically divided into thermal conductivity, mass transfer and variation of bonds between the components of the system. Heat transfer plays an important role in the consideration of electrical phenomena.

Figure 4

Physico-chemical processes occurring in earth materials.

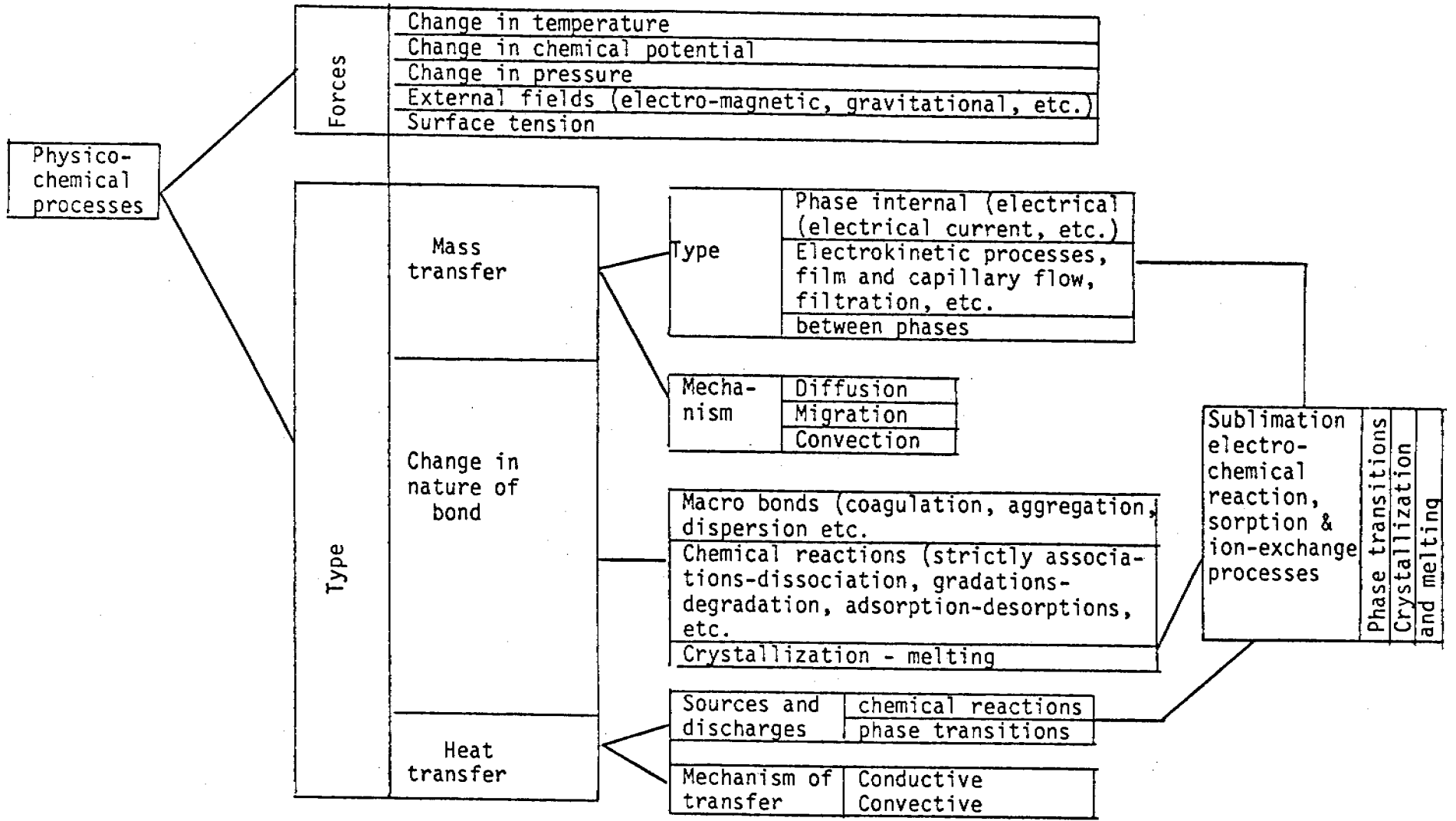

Mass transfer consists of:

- a) intraphase movement of components, induced by heterogeneity of distribution, differing mobilities and also of their migration due to the action of external forces;
- b) movements across the interface of phases - a result of heterogenous reactions;
- c) movements with phase.

Currents determining mass transfer, beyond the interfaces of phases comprise diffusion, migration and convective currents. Ions and molecules, electrons and vacancies are attracted into the currents; the currents can be volumetric and surface. The total current of charged particles with respect to the dislocation current determines the full electrical current.

A change in the bonds between the components of the system can occur at different levels: atomic (chemical interaction; formation and recombination of pairs; electron-vacancy, $\text{OH}^- - \text{H}_3\text{O}^+$; chemisorption, dissociation-association of molecules), molecular (phase transitions, formation of pairs L -, D - defects; change in texture of the substance: hydration; physical adsorption) and at the level of more structured material, (coagulation-dispersion, sedimentation, etc.) (Savel'ev, 1971; Fletcher, 1970). A change in the bonds is described by equations of chemical kinetics in which the speed of the reaction is determined in accordance with the law of moving masses and is dependent on the concentration of the reacting components, the energy of activation and changes of the electric potential of components in the reaction.

Equations of currents and equations of chemical kinetics are linked by equations of continuum, which at the interface of phases connect the electrical currents with the currents of the reaction and with the change of structure of double electric layers.

Equations of mass transfer and changes of bonds are supplemented with equations of the electromagnetic field in the heterogeneous medium (Mel'nikov et al., 1974; Gennadinik et al., 1976).

Research methods are determined by the characteristics of the subject of the research, that is:

- a) by the parameters of the electromagnetic field being studied (cf. Figure 3) (type of field, frequency spectrum, intensity, orientation, limits of change and sensitivity to changes in conditions);
- b) the processes with which the field is connected (mechanism, scale, relaxation times);
- c) texture of the object of research determining the geometry of the distribution region of the field and the occurrence of the process (structure of the section, texture of the materials or of the phase components of the materials);
- d) influence of the external conditions on the nature of the occurrence of the physico-chemical processes and on the parameters of the texture of the object on which the processes determining the field are dependent.

Experimental research includes laboratory research on artificially produced models, and field research on geological sections in conditions of natural bedding. All electrophysical methods can be used in the laboratory (Savel'ev, 1971; Eizenberg, Kautsman, 1975); all methods of electrometry (a branch of geophysics concerned with the measurement of electromagnetic fields for the purpose of studying the structure of the geological cross-section (Akimov, Klishes, 1976)) can be used in field research.

Methods for studying low frequency polarization and distribution of current provide the most information on the state of the section. In

earth materials, both are connected primarily with electrochemical processes, therefore it is natural for the parameters describing the bond between the field and the state of the object to take up the electrochemical activity of the materials which unite the following:

1. Natural electrochemical activity indirectly reflecting the processes taking place in the materials and conforming to the "electrochemical activity" accepted in geophysics (Kobranova, 1962). Under the conditions of permafrost zone, it must be supplemented by the capacity of the materials to create a field upon freezing. In exploratory geophysics it is acceptable to consider that the natural electrochemical activity reflects the state of equilibrium of the section or the steady-state processes occurring within it, as applied to the active layer it varies with time in accordance with the cycle change of the external conditions.
2. The specific conductivity of the materials of the geologic section or the effective conductivity of the section being studied when its geometrization is made difficult (in the active layer). Study of its spatial distribution allows the geological section to be broken down into objects. A change in conductivity with time reflects the state of the object (Figure 5).
3. The induced electrochemical activity connected with electrokinetic and electrode processes artificially induced in the materials. Its occurrence is determined by the nature of excitement and registration of the field, therefore, the parameters describing it are widely divergent (Gennadnik et al., 1976). The study of induced electrochemical activity is associated with considerable technical difficulties, since secondary signals are more than an order of magnitude weaker than primary ones. Therefore, at

the present time, it is only their linear characteristics, as a rule, that reflect the textural characteristics of current-carrying channels in the earth materials being studied.

The limits of change of apparent contradictions and polarizations (one of the parameters of induced activity) in the annual cycle is shown in Figures 5 and 6. It indicates a large range and a regular change with time in the parameters under investigation.

Figure 5

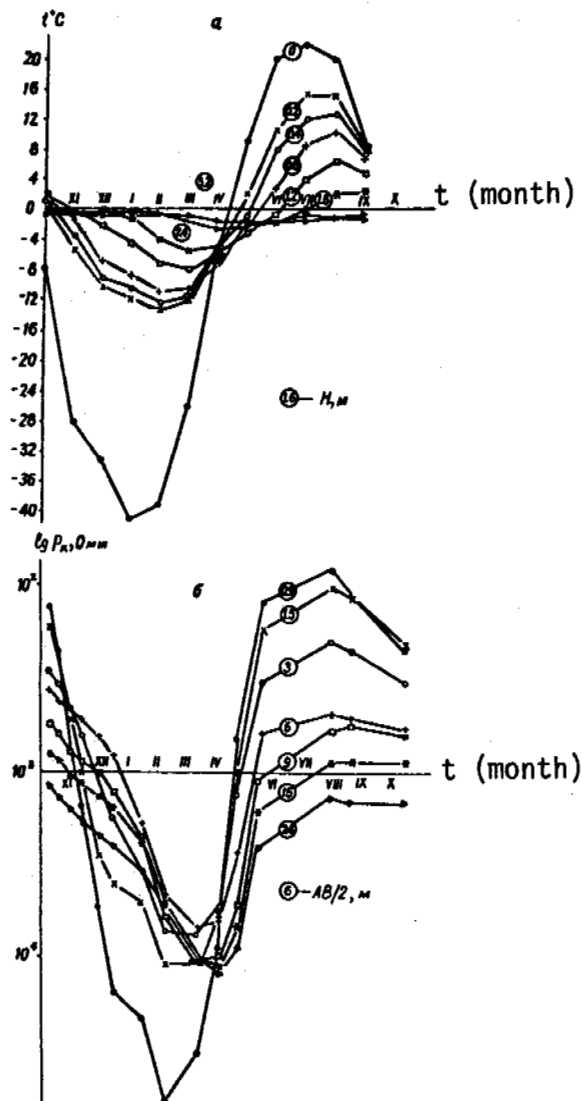

Temperature change and ρ_b , measured by the Vanner arrangement, in the yearly cycle (base, town of Yakutsk).

Figure 6

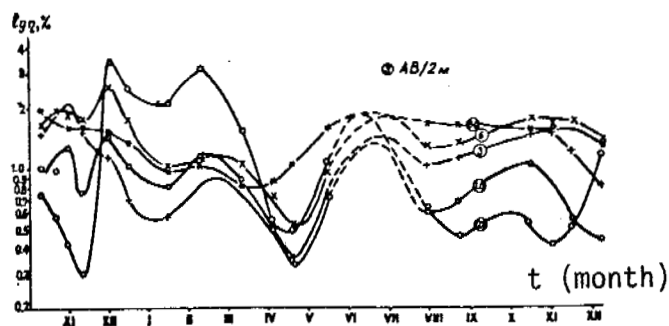

Change in apparent polarization in the annual cycle
(base, town of Yakutsk).

A theoretical description of the electrochemical activity is based on a model of the earth materials. Models are selected on the basis of research problems, taking into account the characteristics of the mechanism of the processes occurring in the materials. The most common are models for neutralizing a field; these are based on investigation of currents and distribution of charges in the heterogeneous medium (Mel'nikov et al., 1974), which allow a qualitative picture of the phenomenon to be obtained. A quantitative description of the electrochemical activity is based on the establishment of a link between electrochemical polarization and the physicochemical processes in elementary electrolyte nuclei. In the volume of averaging of the electromagnetic field, the quantity of this type of nucleus is measured in millions. Therefore, only the mean parameters of the nuclei and the limits of their change and likewise their relative distribution in the presence of such a pattern, are of significance.

When describing electrochemical processes which determine the electrochemical activity of materials with ionic conductivity, a capillary model is used (Gennadinik et al., 1976). Elements of this model, as applied to frozen materials are presented in Figure 7. Their variety determines the wide range of change in electrochemical activity of permafrost and changes occurring during freeze-thaw. The presence of unstable elements and of elements with widely divergent properties (double electric layers of various types) requires consideration of the changeability of the model with time, and likewise changes in membranous potentials when there is a flow of current (the latter may lead to an occurrence of polarization of the reverse type).

Figure 7

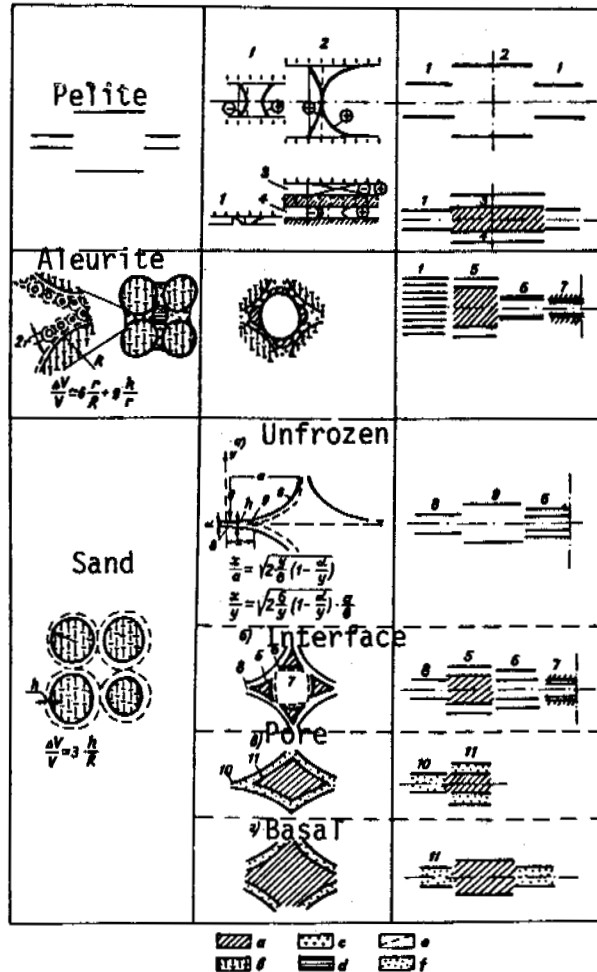

Component of earth materials and changes experienced upon freezing depending upon dispersion, sorting and water saturation. a - ice; b - dielectric; c - clay; d - liquid; e - boundary gas-liquid film; f - concentrated electrolyte solution).

1-11 - types of liquid films (according to structures); $\Delta V/V$ relationship of volume of unfrozen film to volume of granules of the dielectric in unsorted and sorted materials. In the capillaries (1-3) deflection of the concentration of colloidal ions and counter ions from equilibrium in the diffuse part of the double electric layer are represented schematically.

We must give the model describing the flow of current in materials with basal ice cement separate considerations. The capillary model in this case is unacceptable, since the presence of elements of the current carrying channels having sharply differing conductivities (ice and concentrated solution) requires consideration of their relative spatial distribution,

i.e., fixation of grains of the dielectric that have specific dimensions and form, and are perpetually surrounded by a thin film of finite conductivity, in a surface polarized medium of high resistance such as ice-cement (Gennadinik et al., 1971). Surface polarization is associated with the impediment of current flow through the surface of the ice crystal - the surface is surmountable by H and OH⁻ ions, while in the concentrated solution of the film enveloping the grain of the dielectric electrolyte ions are the main current carriers, and in ice crystals L - and D - are defects.

REFERENCES

1. AKIMOV A.T. and KLISHES T.M. Vozmozhnosti distantsionnykh metody proizvodstva izyskaniy v raionakh vechnoi merzloty. (Potentials of distant reading methods in conducting surveys in the Permafrost region). In the book: Geofizicheskie metody issledovaniya merzlykh tolshch. (Geophysical methods in permafrost research). Yakutsk, pp. 151-160, 1976.
2. GENNADINIK B.I., LEMETS V.I. and NABOKO Yu.S. Teoreticheskie otsenki vliyaniya razlichnykh faktorov na polyarizuemost' sred, soderszhashchikh rasseyannye elektroprovodyashchie vklyucheniya. (Theoretical evaluation of the influence of various factors on the polarizability of media containing electron conducting inclusions). Alma-Ata, 99 pages, 1971.
3. GENNADINIK B.I., MEL'NIKOV V.P. and GENNADINIK G.V. Teoriya vyzvannoi elektrokhimicheskoi aktivnosti gornyykh porod. (Theory of induced electrochemical activity of earth materials). Yakutsk, 160 pages, 1976.
4. DOSTOVALOV B.N. and KUDRYAVTSEV V.A. Obshchee merzlotovedenie. (General permafrost studies). Izd-vo MGU, 403 pages, 1967.
5. KOBRANOVA V.N. Fizicheskie svoystva gornyykh porod. (Physical properties of earth materials). M., Gostoptekhizdat, 490 pages, 1962.
6. MEL'NIKOV V.P. Elektrofizicheskie issledovaniya merzlykh porod. (Metodologiya i praktika). (Electrophysical permafrost research (Methods and practice)). Novosibirsk, "Nauka", 1977.
7. MEL'NIKOV V.P. and GENNADINIK B.I. et al., Osnovy amplitudnofazovykh izmereniy vyzvannoi polyarizatsii. (Principles of gain phase measurement of induced polarization). Yakutsk, 222 pages, 1974.
8. MEL'NIKOVA A.M. Razdelenie zaryadov pri kristallizatsii. (Separation of charges during crystallization). "Kristallografiya", Vol. 14, No. 3, pp. 548-563, 1969.

9. PARKHOMENKO E.I. Elektricheskie svoistva gornykh porod. (Electrical properties of earth materials). M., "Nauka", 164 pages, 1965.
10. SAVEL'EV B.A. Fizika, khimiya i stroenie prirodnykh l'dov i merzlykh gornykh porod. (Physics, chemistry and structure of naturally occurring ice and permafrost). Izd-vo MGU, 507 pages, 1971.
11. EIZENBERG D. and KAUTSMAN V. Struktura i svoistva vody. (Structure and properties of water). L., Gidrometeoizdat, 280 pages, 1975.
12. FLETCHER N.H. The chemical physics of ice. Cambridge University Press, 271 pages, 1970.

THERMAL INTERACTION OF PIPELINES WITH THE GROUND

L.S. Garagulya, S.Yu. Parmuzin, V.V. Spiridonov and A.S. Tsurikov
All-Union Research Institute for Pipeline Construction
Moscow, U.S.S.R.

Construction and operation of pipelines in the permafrost region present many problems. To a large extent this is due to the fact that thermal interaction of pipelines with the ground, as well as the effect of construction on the environmental conditions bring about considerable changes in the temperature, composition, texture and properties of the ground. A change in its temperature regime results not only in an abrupt change in the bearing strength of the subgrade but also in a rapid development of various processes in the ground which exert a mechanical effect on the pipe. Therefore the choice of construction method, strength of the pipe and design solutions must be based on correctly estimated changes in the ground temperature regime under given conditions which may occur during construction and operation of the pipeline.

There are vast differences in the way perennially and seasonally frozen ground is affected by construction and subsequent operation of the pipeline. During construction the temperature regime at the ground surface is disturbed due to the removal of vegetation, site preparation, construction of auxiliary roads, placing fill for embankments, excavation of cuts, etc. This results in a single change in conditions at the ground surface and does not produce any additional sources of heat. If this is not followed by a progressive development of thermokarst, thermal erosion, etc., a temperature field, which will be different from the initial field and will change in accordance with the climate, will be established after a certain period of time beyond the zone of the thermal effect of the pipeline.

An estimate of possible changes in the temperature regime of the ground resulting from construction is required to determine the thermal state of the ground to be used as an initial condition in the calculation of the interaction of the pipeline with the ground during the operational period. It is also required to predict the possible occurrence of various frozen ground phenomena along the route.

The subgrade will be subjected to the thermal effect of the pipeline once the latter is in operation. In some cases the pipe is a constant source of heat throughout the operational period. In other cases, it has hardly any effect on the thermal regime of the ground formed during the construction period.

An estimate of changes in permafrost conditions during the operational period is essential for determining initial data on the thermal state of the ground, when forecasting permafrost processes and phenomena; for calculations of the depth of seasonal and perennial areas of freezing and thawing of the ground around the pipelines, and of the amount of ice forming on offshore pipelines; for determining changes in the temperature of heat carriers, for the length of the pipeline, and for calculation of the pipeline capacity. A forecast of change in the ground temperature regime when affected by the pipeline is obtained for the given construction method, the design solution selected, and for the technological conditions for transporting the product.

Pipelines are linear constructions which cross various types of terrain that are characterized by one or more features and determine the design and operational conditions. Therefore, when planning pipelines, it is essential to choose a method of forecasting changes in permafrost and geological engineering conditions which would allow a quantitative estimate of changes in environmental conditions to be obtained on the basis of the data of surveys within each type of terrain. This means that a two way dependence between the environmental factors and parameters of construction on the one hand, and the characteristics of the ground temperature regime on the other, must be established quantitatively. Only with the help of such data is it possible to work out effective measures for controlled modification of permafrost conditions.

The requirements of detail in forecasting the thermal interaction of pipelines with the ground differ at various planning stages. During preliminary surveys, optimum control of right-of-way route, construction method, and operational technology are selected. Therefore, when forecasting, the main focus at this stage is on estimating the likelihood of changes in the ground temperature regime, and the consequences for work on construction and transformation of the surrounding milieu; depending on the nature of technogenic action within the limits of the basic landscape types. Fundamental to the forecast is the map of preliminary regionalization of future routing corridors, compiled on the basis of reconnaissance research, with wide use of the literature and allocated materials. Calculations of the temperature regime and thaw areas takes place for various types of pipeline construction methods (surface, buried, above-ground), and with several variants of the temperature regime of the heat carrier (above-zero and below-zero mean annual temperature of the gas).

On the basis of experience in forecasting at the Department of Petroleum Energy (TEO), basic initial data for calculation of the interaction between pipelines and the ground are: the given temperature regime of the heat carrier; the climatic characteristics of the region; composition and properties of the ground, and its mean annual temperature under natural conditions. In this case, the possible limits of changes in environmental conditions in each microregion are selected. A forecast is produced for the mean values of the selected characteristics and for the least favourable combinations of the latter. Preliminary forecasting allows evaluation of the degree of complexity of the conditions of interaction between pipeline and ground, under different construction methods and operational systems, optimum control of routes; and selection of the most reliable and economical construction solutions.

The basic problems in forecasting the thermal interaction between pipelines and ground during the stages of technical planning and preparation of working drawings are the calculation of changes in the temperature regime in the construction area and in the zone affected by the pipeline for the construction method and the technical operating conditions selected. At this stage, initial data on environmental conditions used for forecasting, are the

characteristics obtained during the permafrost survey and the route survey. When forecasting changes in the environmental conditions of the construction area, the following are taken into account:

- a) mean annual temperature of the ground at the surface, deep within the layer of seasonal thawing (freezing), and at the depth of zero annual amplitude;
- b) temperature amplitude at the surface of the earth materials and deep in the layer of seasonal thawing (freezing);
- c) thickness of the layer of annual temperature fluctuation;
- d) thickness of layer of seasonal and potential thawing (freezing) of the ground;
- e) change in temperatures of the ground at different depths, with time;
- f) time of freezing of layer of seasonal thawing, and temperature of the ground at the moment of complete freezing;
- g) temperature gradients in frozen and thawed materials.

In the zone of thermal interaction between the pipeline and the ground, for the given design solutions and gas temperature regime the following are taken into account:

- a) temperature regime at the surface of the pipe and change in temperature of the casing, for the length of the pipeline;
- b) thickness of seasonal and perennial areas of thawing and freezing of the ground beneath the pipeline.

In permafrost regions, depending on the temperature regime of the product being transported, the problem of formation of areas of thawing and freezing can include:

1. Determination of depths of seasonal thawing of the ground beneath the pipeline in which the temperature of the product they contain varies in accordance with $t_{\Pi} < 0^{\circ}\text{C}$, $A_{\Pi} > |t_{\Pi}|$ (t_{Π} - mean annual temperature of the product; A_{Π} - physical amplitude of annual fluctuation of the temperature of the product);
2. determination of the depth of seasonal freezing of the ground in the thaw basin forming beneath the pipelines in which the temperature of the product varies in accordance with $t_{\Pi} > 0^{\circ}\text{C}$ and $A_{\Pi} > t_{\Pi}$;
3. determination of the depth of perennial thawing of the ground beneath pipelines, the temperature of the product they contain varies periodically when $t_{\Pi} > 0^{\circ}\text{C}$;
4. determination of the areas of perennial thawing, when there is a constant above zero temperature of the product, beneath underground and ground surface pipelines;
5. determination of the depth of seasonal freezing of the ground beneath the pipelines in which the temperature of the product periodically varies in accordance with $t_{\Pi} > 0^{\circ}\text{C}$, $A_{\Pi} > t_{\Pi}$;
6. determination of the depth of seasonal thawing of the ground in the area where permafrost is forming beneath the pipelines in which the temperature of the product periodically varies in accordance with $t_{\Pi} < 0^{\circ}\text{C}$, $A_{\Pi} > |t_{\Pi}|$;

7. determination of the depth of permafrost under the pipelines in which the temperature of the product varies when $t_{II} < 0^{\circ}\text{C}$;
8. determination of the areas of perennial freezing of the ground under the pipelines, when the temperature of the product is constantly below zero.

Changes in the environmental conditions during construction of pipelines are virtually no different than those disturbances that take place during other types of construction: railway, industrial, civil. This permits use of existing methods for solving problems concerning the formation of the ground temperature regime, depending on the effect of such factors as the thermal radiation balance at the Earth's surface, snow and vegetation covers, swampiness, composition and moisture content of the ground, etc. (Balobaev, 1963; Melamed, 1966; Pavlov, 1975; Porxaev, 1970, 1973, etc.). In our opinion, the most complex are the methods worked out in the Department of Permafrost Studies of Moscow University, under the direction of V.A. Kudryavtsev (Dostovalov, Kudryavtsev, 1969; Kudryavtsev et al., 1974). This method is based on calculation of the ground temperature regime by means of subsequent summation of the effect of individual factors. The advantage of this method is in its simplicity, and in the fact that the initial data for the calculation can be obtained easily during a permafrost survey (research). Implementation of this method allows successful analysis of the pattern of formation of the ground temperature regime and of the depths of seasonal thawing and freezing, which is essential for control of the permafrost processes as a whole.

Thermal interaction of pipelines with the surrounding milieu can be studied by long term field observations of routes or experimental areas, with the help of physical simulation under laboratory conditions or on analog machines (Hydro - and electro integrators) and by mathematical methods. Since indirect observations and physical simulation necessitate a significant waste of time and, moreover, are not always able to characterize possible or proposed changes in the technological parameters of the pipeline systems or to take into account the changeability of the factors of the environmental

conditions, the most widely used in planning are the mathematical methods for studying the thermal interaction of pipelines with the ground.

As a result of the complexity of the physical processes of heat distribution in freezing and thawing ground, it is very difficult to conduct analytical research into the dynamics of the temperature field in perennially frozen ground around buried and surface pipelines. The process of heat transfer in ground is not steady; it is brought about by the phase transitions of water in the freezing process, by the alternation of periods of freezing and thawing with some mobile surfaces at the interface of phases, the laws of which were hitherto unknown.

The problem of heat distribution around the pipeline is three dimensional and is formally described by a system of differential equations of thermal conductivity for frozen and thawed ground, snow cover and the heat carrier, with the Stefan nonlinear boundary condition on the mobile boundary between the phases. It is not possible to solve this type of problem analytically: a problem of disequilibrium of thermal exchange between pipelines and the ground, with boundary conditions which fully correspond to the actual process of heat-exchange in the ground. A solution to the problem has only been found for individual cases when a simplification in the formulation of the problem has been permissible. If it is accepted that the temperature of the product in the pipeline does not depend on the coordinates, and is only a function of time, then the problem becomes a two dimensional Stefan type problem for the complex doubly connected region with several fronts of freezing and thawing. Use of a computer opens considerably possibilities for solving this type of problem. However, even here the presence of a horizontal upper ground surface and its horizontally layered non-uniformity create special problems in developing a solution, because of the impossibility of using cylindrical coordinates. Therefore, even when significant allowances are made during formulation of the problem, research into the dynamics of the temperature field in the ground around the pipeline must be conducted in a rectangle with a semicircle removed.

An analog computer (AVM) is used for research into the pattern of formation of areas of thawing; this allows a solution to be obtained for the

two dimensional type of Stefan problem. One of the most widely used devices is the hydrointegrator of V.S. Luk'anov's system (1957).

When analog and digital computers were used to solve the two dimensional problem of calculating thawing and freezing around buried pipelines, and beneath surface pipelines, the results showed that, in a number of cases, the two dimensional problems could be reduced to one dimensional and available analytical solutions of one dimensional problems could be used successfully for engineering calculations that are necessary when planning a pipeline. In particular, I.A. Charnii's well known equation (1940) for calculating perennial areas of thawing or freezing of ground beneath pipelines can be used. Smoothing used in the derivation of the equation leads to exaggerated results. In order to obtain more accurate results, we have worked out a method for determining the initial theoretical values of temperature at the pipeline surface and period of thawing and freezing of the ground; these values take into consideration the disequilibrium of the process and the periodicity of the change in temperature of the product being transported. Correction factors that take into consideration the depth of bedding of the pipeline are obtained in a similar way. For speed and simplicity of computations, nomograms are composed.

For cases when it is not permissible to disregard heat losses for the thermal capacity of the ground, an analytical solution to the problem similar to that of I.A. Charnii is proposed. The formulas for evaluating the effect of heat insulation on the process of thawing (freezing) of the ground was obtained in an analogous way.

Analysis of various materials showed that for calculating seasonal areas of freezing of ground beneath pipelines (depending on the temperature regime of the product being transported, the temperature regime, composition and moisture content of the ground), it is expedient to use the method of V.A. Kudryavtsev et al., (1973), taking into account their recommendations for determining calculated values of the temperature of the pipeline surface; these are presented below.

As in the permafrost region, so it is in the regions with seasonal freezing of ground: the most complex case is when seasonal areas of freezing (thawing) form against a background of perennial thawing (freezing). In these cases, the seasonal and perennial processes of thawing and freezing take place under conditions where the temperature regime of the ground has not become established, i.e., as the front of perennial thawing (or freezing) advances, a measurement of the mean annual temperature of the ground within the perennial area of thawing is taken. Existing engineering methods for calculating seasonal areas of thawing (freezing) of the ground do not allow the disequilibrium of the temperature field of the ground in the perennial cycle to be taken into consideration. Possible combinations of the temperatures of ground and pipeline during seasonal interaction of pipelines with freezing and thawing ground can be reduced to four basic cases.

1. In permafrost regions, when there are subzero mean annual temperatures at the pipe surface and there are periodic fluctuations in temperature of the heat carrier with an amplitude greater than the absolute value of the mean annual temperature of the pipe, seasonal areas of thawing of the ground will form. In this case, during the first year of operation, the maximum thickness of seasonal thawing of ground beneath the pipe will be observed when the mean annual temperature of the pipe surface is lower than the mean annual temperature of the ground. In subsequent years, the thickness of the seasonal areas of thawing of the ground beneath the pipe will decrease. If the mean annual temperature of the casing of the pipeline exceeds the mean annual temperature of the ground, then in the first year of operation areas of thawing of ground will be of minimum thickness. As the mean annual temperature of the ground rises, as a result of the effect of the pipeline, the thickness of the areas of thawing of the ground will increase; it will attain maximum values when a stable regime becomes established in the ground: when the temperature is close to the mean annual temperature of the pipeline.

2. In regions of thawed earth materials, when there are above zero mean annual temperatures at the surface of the pipeline, and there are periodic fluctuations in the temperature with an amplitude exceeding the value of the mean annual temperature of the pipe, every year, at the coldest

time of the year, areas of freezing will form beneath the pipes. In this case, the maximum thickness of the areas of freezing of the ground will be attained during the first year of operation, whenever the mean annual temperature of the surface of the pipeline exceeds the mean annual temperature of the ground. In consequent years, as a stable regime becomes established and the temperature of the ground in the zone affected by the pipeline rises, the areas of seasonal freezing will decrease. In this case, when the mean annual temperature of the surface of the pipeline is below that of the ground, minimum seasonal freezing of the ground beneath the pipeline will be observed during the first year of operation.

Later, as the temperature of the ground becomes lower and it approaches the mean annual temperature of the pipeline, an increase in the depth of seasonal areas of freezing will be observed.

3. In the case where a pipeline with temperatures above zero is laid in permafrost, perennial thawing of the ground will take place. In this case, in the coldest part of the year, when the temperature at the surface of the pipeline is below zero, there will be seasonal freezing of the ground. Maximum thickness of seasonal freezing will take place during the first year of operation when the ground temperatures will be close to 0°C . In subsequent years, due to the influence of the pipeline, the mean annual temperature of the ground in the area of perennial thawing will rise and there will be a corresponding decrease in the areas of freezing of ground beneath the pipelines.

4. If a pipeline with a subzero temperature is laid in thawed ground, perennial areas of freezing will form around it. When there are periodic fluctuations in temperature at the surface of the pipeline with an amplitude above the absolute value of the mean annual temperature of the pipeline, against a background of perennial freezing, seasonal areas of thawing of the ground will form in the summer months. As in the above case, the maximum thickness of seasonal thawing will be recorded in the first year of operation, when the ground temperatures are close to 0°C . In subsequent years, the thickness of the seasonally thawed ground around the pipeline will decrease.

When planning pipelines, the very worst conditions of interacting of pipe and thawing and freezing ground should be taken into consideration. Therefore, it is expedient to consider the maximum areas of freezing and thawing of ground beneath pipelines.

The processes of convective heat exchange, caused by heat and moisture transfer in the ground, can substantially raise the mean annual temperature of the ground and can lead to an increase in areas of thawing ground beneath pipelines. Calculation systems taking into account the convective component of heat exchange in the ground are very complex and can only be solved with the aid of a computer. Moreover, for the initial parameters, special observations during surveying are required for their solution. As a first approximation, an increase in the thickness of seasonal areas of thawing beneath pipelines, due to the effect of infiltrating atmospheric settlements and the warming action of suprapermafrost water, can be evaluated by means of the introduction of a correction factor. Calculation of the thickness of the areas of thawing of the ground is multiplied by the coefficient n , the value of which depends on the composition, the properties of the ground, the time the horizon of suprapermafrost water has been in existence, and the quantity of summer rainfall (Table).

Thermal interaction of a pipeline with the surrounding milieu leads to a change in the temperature of the product being transported. Determination of heat loss by the pipeline is necessary not only for correct forecasting of changes in permafrost conditions, but also for determining the temperatures of deformation of pipes, and the capacity of the system. As research has shown, calculation of the change in the temperature of the product must take into account the technological and design peculiarities of the pipeline, and the change with time of the coefficient of heat transfer from the pipe to the surrounding milieu. The value of the heat transfer coefficient depends on the formation and growth of the areas of thawing and freezing of the ground around the pipeline, therefore it changes substantially during the operational period. In order to determine this value, along with the numerical solutions to the problem obtained by computer, approximation equations can also be used.

TABLE

Values of the correction factor 'n' which takes into consideration the effect of convective heat exchange on the dimensions of the areas of thawing earth materials.

Earth materials	Coefficient of Infiltration of materials, m/day	Period of existence of horizon of suprapermafrost water.	Summer rainfall		n
			mm		
Suglinok with thin layers of supes and sand	0.3 - 0.5	Occurs periodically*	<200		1.05
		Constant occurrence	>200		1.1
		Occurs periodically*	>200		1.1
Supes and fine sand	0.5 - 5.0	Constant occurrence	<200		1.3
		Temporary occurrence**	>200		1.2
		Constant occurrence	>200		1.5
Sand and coarse detrital materials with sandy-supes fill.	5 - 10	Occurs periodically*	<200		1.3
		Constant occurrence	<200		2.0
		Temporary occurrence**	>200		1.5
		Constant occurrence	>200		>2.0
Coarse detrital materials with sand or a small amount of supes fill	10 - 30	Occurs periodically*	<200		1.5
		Constant occurrence	<200	2.5 - 3.0	
		Temporary occurrence**	>200		2.0
		Constant occurrence	>200		>3.0

* Horizon of suprapermafrost water occurs when it rains and there is intense thawing of ice saturated earth materials. Quick action, over in a few days.

** Feeding of horizon suprapermafrost water is due to surface flow, infiltration of atmospheric settlements, and thawing of ice saturated materials. Exists for about half the summer.

In conclusion, it should be noted that the method of studying the thermal interaction of pipelines with the ground cannot be reduced to thermotechnical calculations alone. The forecast of change in permafrost conditions, resulting from construction and operation must include a comprehensive study of the patterns of formation and the dynamics of the development of seasonally and perennially frozen ground.

REFERENCES

- BALOBAEV, V.T. Protaiwanie merzlykh gornykh porod pri vzaimodeistvii s atmosferoi. (Thawing of permafrost as a result of interaction with the atmosphere). In the book: Teplo- i massoobmen v merzlykh tolshchakh zemnoi kory. (Heat and mass exchange in the permafrost of the Earth's crust). M., Izd-vo AN SSSR, pp. 105-116, 1963.
- DOSTOVALOV, B.N. and KUDRYAVTSEV, V.A. Obshchee merzltovedenie. (General permafrost studies). Izd-vo MGU. 402 pages, 1969.
- KUDRYAVTSEV, V.A., GARAGULYA, L.S., KONDRAT'EVA, K.A. and MELAMED, V.G. Osnovy merzlotnogo prognoza pri inzhenerno-geologicheskikh issledovaniyakh v oblasti mnogoletnemerzlykh porod. (Basics of permafrost forecasting for geological engineering research in permafrost zones). Izd-vo MGU, 431 pages, 1974.
- KUDRYAVTSEV, V.A., MELAMED, V.G., KONDRAT'EVA, V.G. and MEDVEDEV, A.V. Nomogrammy dlya rascheta glubin sezonnogo ottaivaniya (protaivaniya) gruntov vokrug zagublennogo truboprovoda s uchetom izmeneniya ego temperatunogo rezhima po dline truby. (Nomograms for calculating depths of seasonal thawing (freezing) of the ground around buried pipelines with regard to changes in the temperature regime along the pipe). In the book: Merzlotnye issledovaniya. (Permafrost Research), No. 13, Izd-vo MGU, pp. 142-148, 1973.
- LUK'YANOV, V.S. and GOLOVKO, M.D. Raschet glubiny promerzaniya gruntov. (Calculation of depth of freezing earth materials). M., Transzheldorizdat, 163 pages, 1957.
- MELAMED, V.G. Promerzanie poristykh tel s uchetom krivoi nezamerzshei vody v avtomodel'nom slucai (klassicheskaya zadacha Stefana). (Freezing of porous bodies with respect to the curve of the nonfrozen water in the self-modelling cases (Classic Stefan problem)). In the book: Merzlotnye issledovaniya. (Permafrost Research), No. 5, Izd-vo MGU, pp. 19-25, 1966.
- PAVLOV, A.V. Teploobmen pochvy s atmosferoi v severnykh i umerennykh shirotakh territorii SSSR. (Heat exchange between soils and the atmosphere in northern and temperate latitudes of the U.S.S.R.). Yakutsk, 304 pages, 1975.

PORKHAEV, G.V. Teplovoe vzaimodeistvie zdani i sooruzhenii s vechnomerzlymi gruntami. (Thermal interaction of buildings and structures with the permafrost). M., "Nauka", 208 pages, 1970.

FEL'DMAN, G.M. Metody rascheta temperaturnogo rezhima merzlykh gruntov. (Methods of calculating the temperature regime of permafrost). M., "Nauka", 208 pages, 1973.

CHARNYI, I.A. Raschet skorosti zamorazhivaniya gruntov. (Calculations of the rate of freezing of earth materials). "Sovetskii metropoliten", No. 4, pp. 29-34, 1940.

PRESENT STATE OF RESEARCH ON THE FREEZING OF ROCKS AND
CONSTRUCTION MATERIALS

Jaime Aguirre-Puente

Laboratoire d'Aérothermique du Centre National de la Recherche Scientifique

1. Introduction

Two major groups of researchers dealing with problems related to the freezing of rocks were gathered at that international conference*:

- a) geomorphologists, geologists and geographers, who, both at high latitudes and in now temperate regions, must study the existence of frost at high latitudes, in mountainous areas or elsewhere formed during past periods of glaciation;
- b) engineers, who must control seasonal frost action and its effects on natural stone and ceramic and concrete construction materials.

In view of the great variety of elementary physical phenomena involved in the freezing of scattered materials, other fields of research were also represented: thermal engineers, physical chemists, specialists of porous materials, highway engineers, experts on the freezing of biological tissue^{37,39)}, mathematicians and metallurgists³⁶⁾.

* The sixth international conference of the Fondation française d'études nordiques, under the theme "Problems raised by frost-shattering. Pure and applied research (rocks and artificial construction materials), held in Le Havre, April 23-25, 1975⁴⁶⁾". The conference was organized in co-operation with the Laboratoire d'aérothermique of the CNRS (Meudon) and the Commission de géographie polaire of the Comité national de géographie (Paris).
Chairman: Jaime Aguirre-Puente.

The subjects dealt with during the conference cannot be analyzed within the scope of the present paper: the full text of the 45 papers delivered at the conference (cf. references) may be found, together with the discussions and conclusions, in reference 46. A more detailed account of the conference may be found in references 47 and 49.

The following is a survey of a few of the general conclusions, with suggestions as to some research goals which would increase our knowledge of the freezing of rocks.

2. General aspects

The freezing of soils, rocks and artificial materials such as concrete and ceramic tiles and bricks is a matter of heat transfer and mass transfer in porous materials containing some water.

In terms of structure, there are two types of porous materials:

- a) porous materials showing little or no consolidation, e.g., soils and certain chalks;
- b) consolidated porous materials such as natural rocks, concrete and most ceramics.

As for the first type, it is assumed that the porous matrix is formed of solid particles that are more or less in contact depending on the confining pressures. With respect to the second type, the porous matrix may be considered as a continuous solid with a more or less regular network of voids and cracks in which water and air may accumulate.

Research on the freezing of soils during the last few decades has led to solutions for certain urgent problems raised by highway engineering^{3,13,17}). Basic research has played a major role in the acquisition of this knowledge, providing, in particular, physical models for phenomena verified by experimental research^{1,34,49,53}).

Thus, a coherent and fairly complete outline is now available to explain cryogenic phenomena, from microscopic pores to macroscopic bodies encountered in road construction or certain areas of permafrost.

This does not hold true for rocks and artificial stones, the mechanical behaviour of which is a serious obstacle to the establishment of general laws applicable to geomorphological studies or construction engineering.

Moreover, since research on frost-shattering is relatively recent, there has been no special effort to unify the bits of information acquired by specialists of the various disciplines concerned.

Most of the information concerning the frost resistance of rocks has been gathered empirically. Geologists and geomorphologists have made a significant contribution by observing events in cold regions or at high latitudes, and by raising questions about the origin of rock fragments left behind by past glaciations in now temperate regions. The geological time under consideration covers thousands or millions of years, and is a factor in the fatigue or progressive fracture of rock fragments during millions of freeze-thaw cycles.

The frost action in natural and artificial construction materials has been studied by construction engineers concerned with safety and the preservation of structures and surface coverings (bridges, dams, buildings, etc.). There the time span covers several generations, and may reach a few hundred years in extreme cases.

The meeting point between these two groups of researchers is the cooling rate of rock, which is the same for natural rocks of a given area and stones used in a high building in the same area.

Several major parameters of frost-shattering have been reported, but practical problems are far from resolved.

It is essential that geophysicists and engineers know the frost resistance of rocks during freezing. Tests have been designed to classify materials according to their frost susceptibility, but these efforts have been carried out independently by geographers, concrete engineers, ceramics experts and engineers using natural stone.

Since the methods, parameters and tests used are very different, it is difficult to make comparisons. It is therefore essential that the problem be tackled on a basic level. Physical analysis will lead more efficiently to a better understanding of the phenomenon and to a more universal formulation.

3. Observations and experiments

3.1. Freezing of soils not entirely confined

The various research results presented at the conference on soil freezing^{3,13,29,34,44}) were based on observations made in the laboratory or in the field^{6,52,54,59}). The following is a brief outline of the frost behaviour of soils. In unconfined soil tests, the material in the experimental cell is open to axial deformation since the plate used to cool one of the specimen faces is not fixed.

During freezing of a fine soil specimen that is sufficiently damp, or provided with an external water supply, there is a significant increase in volume of the frozen zone with respect to the initial volume. The structure of the porous material is completely changed as ice lenses appear, varying in thickness, occurring periodically and usually oriented parallel to the isotherms⁵²).

The heaving observed greatly exceeds that which would result from a variation in the specific volume of the water during the change of state.

In the case of specimens supplied with water, measurements confirm that heaving is equivalent to the amount of water provided by the external source. This water is transformed into ice at the freezing front after passing through the unfrozen zone of the specimen⁵²).

Cryogenic suction, from which this phenomenon originates, was observed directly by measuring the interstitial pressure of the water with tensiometers located along the specimen and influenced by the freezing front^{52,59}).

The thickness of various layers of the specimen increases as the freezing front passes through them from top to bottom. These layers are then pushed upward as a result of the deformation of lower layers. Average heaving per unit length increases as the rate of the freezing front decreases. In certain conditions, a stationary system is established, whereby a single layer of ice swells, separated from the porous material.

3.2 Freezing of confined soils

In other soil freezing experiments, heaving was prevented, and strong confining pressures were measured with sensors^{58,60}).

Resistance to heave is common to all consolidated porous materials where the porous matrix must bear the internal pressures resulting from the transformation of water into ice in the pores.

3.3 Freezing of rocks

The debris left in nature by past cold climates in a given region, or the present state of debris in regions of high altitude or high latitude, are very diversified. Moreover, the arrangement of various types of frost-shattered blocks holds precious geological information. However, the proper interpretation of these morphological features can obviously not be done scientifically unless some attempt is made to understand the complete mechanism of frost-shattering. This problem, reported over the years by geographers, geomorphologists and geologists, is illustrated by the landforms of Greenland, where the types of debris and their natural classification have been well studied³²), bearing witness to the passage of many climates through the ages, which specialists must now decipher.

High altitude observations in mountainous regions more accessible than the Arctic have made it possible to observe systematically the action of frost on rocks. Modern recording methods using photography and aerial stereophotogrammetry in the blue and near ultraviolet range are providing fast and efficient results over considerable areas¹⁹⁾.

Experiments on the freezing of rocks have been carried out by a number of organizations^{7,8,14,15,22,26,33,35)}.

A study of debris after tens or hundreds of freeze-thaw cycles accounts for the three types of frost-shattered blocks: powder, chips and large fragments with their three dimensions of the same order of magnitude.

The very large number of experiments has revealed important aspects of frost-shattering, and has helped formulate working hypotheses about the frost behaviour of porous materials: the evaporation or sublimation of ice, the extrusion of ice, the circulation of water in rock, and the significance of the three-dimensional thermal regime. Moreover, unidimensional experiments have confirmed the importance of cryogenic suction at the surface, producing water circulation in the rock. Very promising measurement techniques have been used in the laboratory or in the field: propagation of ultrasonic waves^{18,22,30,33)}, microscopic observation and physiochemical analyses^{25,26,27)}, dilatometry^{7,22,33)}, thermal, density and grain-size analyses^{14,15,26,28,33,35,43)}, etc.

On the other hand, statistical studies have uncovered predominant parameters in very specific cases, either in nature¹¹⁾ or in the laboratory^{15,23,31)}.

Some studies have led to criteria for the classification of rocks on the basis of their frost susceptibility, others have suggested important parameters which have yet to be studied. Each discipline strives for optimal use of experimental data, but methods of application are generally considered provisional.

4. Analysis

4.1. Microscopic process^{2,53)}

4.1.1. Capillary phenomena

The transition layer between the solid substrate and the water or ice is involved in the process of solidification. Its role is more important as the specific area of the matrix increases. In fact, molecular excitation in free water is characterized by a definite structure and a given molecular order^{57, vol.1)}. Since water molecules are polarized, their excitation is noticeably modified by dissolved ions and those at the boundary. This influence is more pronounced as the size of the cavities decreases and the curvature of the pore walls increases^{57, vol.5)}.

Water molecules in contact with the pore wall line up against it according to the nature of the solid surface. Thus, there is a transition zone from one order (that of the molecules at the wall) to another order (that of the free water). This transition zone consists of so-called "adsorbed water" or "bound water". At each point in the layer of adsorbed water, there is a set of properties or characteristics which differ from those of free water and vary continuously up to the solid substrate. Researchers who have studied this question estimate the thickness of the adsorbed water layer to be 10-100nm^{56,57)}.

As for the ice, its structure is hexagonal within the temperature range of interest to us. The "free" water-ice equilibrium temperature is by definition zero Celsius. Experience shows that this structure is incompatible, as a rule, with that of the substrates encountered in scattered materials, which means that the water-ice equilibrium temperature in the adsorbed water layer decreases with the distance from the substrate^{2,53)}.

The transition from substrate to ice occurs through a generally very thin layer of adsorbed water. The ice/adsorbed water/substrate system may be considered as a three-component interphase that may itself be replaced by a discontinuity surface representing an interface^{55, chap.XX)}. In this new

interface, the "water" component has superficial mobility, and is characterized by a chemical potential. The concept of compatibility between ice structure and substrate structure is very significant: where a substrate is incompatible with the ice, nucleation of the latter occurs at the centre of the pores away from the substrate.

In considering the problem of freezing, two types of phenomena must be dealt with: simple capillary phenomena and adsorption phenomena. The former are those which can be explained and quantified on the basis of thermodynamic interface relations - superficial surface tension, free surface energy, Laplace formula, Thomson formula, Clapeyron-Clausius equation

The second type corresponds to the result of variations in the properties of the water as a function of distance from the substrate within the layer of adsorbed water. In this case, cryoscopic decrease, pressure, mobility, etc., are variables which, unfortunately, cannot be formally evaluated at present.

In cases where simple capillary phenomena are predominant, there continues to be a layer of adsorbed water between the ice and substrate. The molecular order imposed on the water by the substrate follows a direction perpendicular to the pore wall, but nothing prevents the water molecules from moving parallel to the wall (mobility of the "water" component).

4.1.2. Capillary model

The model proposed in references 1, 2, 47, 48, 49, 53 makes it possible to understand the physical process involved in secondary phenomena accompanying the displacement of the freezing front in a porous material. We will only recall here the conclusion of the thermodynamic study of a microscopic element consisting of two pores linked by a small channel, containing water and frozen: in the case where cryogenic phenomena at the pore level are the result of the behaviour of the simple ice-water interface, as in the case where the complex interphase ice/adsorbed water/substrate is predominant, the heat transfer, the behaviour of interphases and the mass transfer represent elementary coupled phenomena.

4.2. Macroscopic analysis^{2,50,51)}

The macroscopic study of the freezing of soils or rocks requires first of all that the conclusions of the microscopic study be transposed to the freezing of water in a porous material. Then, for rocks, it is necessary to consider the mechanical effects of stresses due to the ice when the porous material allows no deformation.

4.2.1. Isothermal system

Let us consider a water-saturated porous material at a constant temperature lower than 0°C . Applying the Thomson formula and the concepts of adsorbed water, we conclude that ice must form in the pore spaces of the material, but that a certain amount of water will remain liquid.

At the macroscopic level, the amount of liquid water and ice depends on the temperature as well as on pore size and distribution.

The concept of adsorbed water suggests that the amount of liquid water and ice also depends on the nature of the porous matrix and on the magnitude of the layer of bound water in relation to pore size.

These conclusions have been confirmed experimentally^{21,61,62)}.

4.2.2. Non-isothermal system

Thermal stresses which cause interstitial water to change into ice produce a thermal gradient in the porous body. On the one hand, the amount of unfrozen water below 0°C is known to depend on the temperature; on the other, the material is known to consist of pores having a great variety of forms and sizes. The freezing penetration through the material is therefore different at each point, so that the freezing front is distorted and follows a fringe of the material where temperatures are close to zero^{50,51)}. Each ice-containing pore is thus a system that behaves like the microscopic model, but the macroscopic systems are the result of all these elementary microscopic effects taking place in the phase change zone.

As the porous material freezes, the phase change zone moves, leaving behind, mainly in the case of soils, ice segregation zones and a modified structure of the porous matrix. As in the case of the microscopic capillary model, the significance of the cryogenic phenomena depends on the coupling of elementary phenomena: heat transfer, interface phenomena and mass transfer. In order to formulate the problem theoretically, however, it is necessary to choose global variables and to establish behaviour laws corresponding to those three elementary phenomena.

4.2.2.1. The suction created by the presence of ice in the freezing zone varies from one point to another; at the macroscopic level, however, the resulting suction per unit area involves the integral of the elementary forces and the porosity of the material. Two problems are raised: evaluating the elementary suction forces and integrating them.

The knowledge acquired does not yet make it possible to determine the elementary suction forces on the basis of chemical potentials and characteristics of the bound water. In some cases, however, the mean diameter of the particles well exceeds the thickness of the bound water. This leads to the hypothesis that the water-ice meniscus is the predominant factor in the creation of this suction; the main function of the adsorbed water is to establish circulation channels between the substrate and the ice, essential to frost heaving. This hypothesis thus simplifies the problem by using the Laplace law for calculations of the pressure drop in the interstitial water of a capillary element in the porous material, assuming that the radius of curvature of the meniscus equals the radius of the pore.

Integrating the suction forces then requires a knowledge of the porosity and pore size distribution of the material.

4.2.2.2. In considering the thermal factor^{16,24,46)} in the study of the freezing of a saturated soil, the pore water temperature is considered to be that of the porous matrix, since the observed slowness of the process suggests a low rate of water circulation. As a result, the behaviour law used is the Fourier law for conducting solids^{40,41,42,46)}.

4.2.2.3. The mass transfer involved in the freezing of soils is the transfer of water produced by cryogenic suction. This process comes under fluid mechanics of porous bodies. Given the pore size, the interstitial pressures involved, and the low rate of flow, Darcy's law can be used as a law of behaviour.

Mathematical models have been established on the basis of these concepts. Numerical solutions are now providing answers to many problems raised by geothermal highway engineering¹³⁾ and to certain other problems encountered in practice or in permafrost zones⁵¹⁾.

4.2.2.4. In the case of a consolidated porous material, the configuration of the network of pores can vary greatly depending on the nature and origin of the substrate. In one and the same material, cracks and pore spaces vary greatly in terms of form, size and pattern, and really determine the total mechanical resistance to external stresses. One particular effect of even minute cracks is to give the rock preferential fracture surfaces.

The capillary model and experiments on confined soils have shown that, in materials that exclude the macroscopic deformation needed for ice segregation, the change of state of the water in the pores produces stresses in the ice, and therefore in the solid matrix. These are in fact mechanical stresses exerted within the material itself⁵⁾. They result from the interface behaviour in each pore, and therefore depend, at the microscopic level, on the type and size of the pores. Their values are very different from one point to another, and though their integration may indicate a total effective value lower than the macroscopic mechanical resistance, there may be local values higher than the critical failure value, as well as variations in structure at the microscopic level.

The present state of our knowledge makes it difficult to use this new aspect in the study of the coupling of elementary processes.

On the basis of the phenomena summarized above, the process was considered at a macroscopic level so as to determine the parameters to be studied and the most appropriate avenues of research.

4.3. Physical process of frost-shattering²⁾

In studying this problem it was found essential to describe the porous matrix, assumed to be completely saturated initially, so as to apply the concepts of the basic study carried out on a microscopic scale.

The designed model makes it possible to explain the occurrence of ice lenses at the surface, fed with water from the rock, and the different types of fracture observed in the field^{28,32,43)} and in the laboratory²⁶⁾.

The flow of water induced by cryogenic suction involves pore size distribution and permeability above and below 0°C. The pressure of the interstitial water and the flow pressure losses in small-diameter capillaries are dependent variables, the value of which is a function mainly of the rate of propagation of the freezing front.

A mild freezing regime will tend to produce ice lenses parallel to the surface of the block and result in stresses that tend to expand the cavities. In fact, in certain rocks, this results in chipping during the first freeze, or progressively during repeated freezing.

On the other hand, the freezing process may be strong and rapid:

- either because the surface temperature drops very low and very fast;
- or because the network of small capillaries has a very low permeability;

it invariably leads to high interstitial water pressures, directly proportional to specimen size. Shattering is frequent in such cases; of course, the number and shape of the fragments depend on the actual pattern of cracks, which provides preferential fracture surfaces.

Fatigue plays a major role in repeated freeze-thaw processes, either by enlarging the cavities progressively and irreversibly during ice

segregation, or through cumulated microscopic changes in the solid structure when critical breaking limits are exceeded locally.

5. Problems raised by frost-shattering and possible avenues for research

5.1. Theoretical research and basic experiments

The preceding qualitative explanation is far from complete, but it does point to the basic mechanism of frost-shattering and some avenues of research for a better understanding of the process.

A first area where a better approach is needed is the description of the porous matrix, which can only be done reasonably through studies of rock structure. Pore size measurements are essential, but they must be controlled by in-depth studies of rock structure through modern monitoring techniques (statistical image analysis, γ rays, X-rays, ultrasonics, infrared radiation) covering each moment of thermal processes.

Another promising area is the experimental and theoretical study of the water permeability of partly frozen matrixes. Models will have to be designed for the study of bound water, either in terms of hydrodynamics (micropolar fluids¹⁾, etc.), or of thermodynamics.

In studying the thermodynamics of cryoscopic lowering and coupling with the interstitial water pressure, the size of the specimen is an important parameter of frost-shattering.

There is a need for more studies of the difficult problem of determining the range of stresses produced in a rock by increased interstitial pressure⁵⁾. The existence of porous systems or crack systems must be considered in mechanical theory³⁸⁾, if only through artificial equivalent networks using geometrical models.

The problem of freezing front propagation (the "Stefan problem") is well known in the absence of secondary phenomena and for unidimensional thermal regimes. In real cases^{4,12)}, complex computation programs are needed

to solve the Stefan problem, since difficulties are compounded as soon as multidimensional geometry is involved and boundary conditions reflect natural conditions more exactly. Moreover, the variable temperature of the front should be considered in terms of the water pressure in the unfrozen zone.

Further physical and mathematical modelling⁵⁾ is needed so that the mechanical resistance of rocks may be considered on the same grounds as other elementary phenomena.

The fluid mechanics of porous materials must be further developed in the case of incompletely saturated bodies and those where pores partly filled with ice lead to variable permeability.

5.2. Systematic experiments

With respect to the determination of the frost susceptibility of rocks, there is a need for more detailed interpretations in the light of the physical mechanics of frost-shattering.

Closer co-operation between geomorphologists and construction engineers would be very useful⁴⁶⁾ through some synthesis of their results. Research on the influence of specimen size and methods of wetting them throughout repeated freeze-thaw tests would be very helpful. Unidimensional tests and stress and strain measurements should continue.

5.3. Direct field observations

Direct field observations and measurements would allow permanent comparisons with theoretical studies.

These observations must be scrupulously systematic, and programmed in terms of the precise aspects under study. Particular attention should be given to observations of rock masses conducted in conjunction with meteorological observations^{20,46)} (changes in surface temperature¹⁷⁾, effects of the wind on the thermal regime and on the rate of water evaporation and ice sublimation¹⁰⁾).

Finally, the effects of the cold on the ice itself⁹⁾, and, in particular, the influence of water solidification in ice cracks³⁸⁾, also deserve further study.

REFERENCES

Papers and proceedings of the 6th international conference of the Fondation française d'études nordiques.

- [1] M. ALDER-VIGNES. Modèle destiné à la simulation du gel dans les milieux poreux. Application au cas réel (rapport 301).
- [2] J. AGUIRRE-PUENTE. Contribution à l'étude du mécanisme physique du gel des roches (rapport 302).
- [3] C. APOSTOLOPOULOS, W. SCHNEIDER. Practical Trials of Insulants Made from Plastics for Frost-protection in Road and Railroad Construction : Comparison of Theory and Practice (rapport 404).
- [4] J.J. BERNARD. Refroidissement par rayonnement des couches de cailloux (rapport 412).
- [5] H. BERTOUILLE. Gélifraction des roches humides (rapport 306).
- [6] M. BIERMANS, K.M. DIJKEMA. Ice Growth at a Porous Plate and at a Single Capillary (rapport 303).
- [7] J.R. BLACHERE. Les essais cycliques de gel et dégel et les théories de la gélivité (rapport 201).
- [8] J.R. BLACHERE. Le gel de l'eau dans les matériaux poreux (rapport 101).
- [9] M. BROCHU. Observations sur la gélifraction par fissures sur la glace du glacier GILMAN (Ile d'Ellesmere, Canada) (Rapport 101).
- [10] M. BROCHU. L'action du vent dans les processus de gélifraction (rapport 401).
- [11] T. BROSSARD. Essai d'application de l'analyse factorielle des correspondances à l'étude des sols structurés en milieu polaire (rapport 102).
- [12] J.P. CALTAGIRONE. Simulation numérique d'une couche poreuse horizontale chauffée par le dessous (rapport 408).
- [13] L. CANIARD, A. DUPAS, M. FREMOND, M. LEVY. Comportement thermique d'une structure routière soumise à un cycle de gel-dégel. Simulations expérimentale et numérique (rapport 308).
- [14] G. FAGERLUND. Studies of the Destruction Mechanism at Freezing of Porous Materials (rapport 202).
- [15] T. FONTAINE. Relation entre la tenue au gel d'un tessou de terre cuite et ses caractéristiques mécaniques et porométriques (rapport 203).
- [16] P.E. FRIVIK, J.H. JOHANSEN, R. SIGURDSEN. Thermal Properties of Soil and Building Materials. Measuring Equipment and Results (rapport 402).
- [17] P.E. FRIVIK, J.M. PEDERSEN. Thermal Regime in Road Constructions. Measurements and Simulation (rapport 409).
- [18] M. FUKUDA. Some Observations about Rock Weathering by Frost upon the Wall Carving (rapport 103).
- [19] G. GALIBERT. Détection de la gélifraction en haute montagne au moyen de la photographie dans le spectre du bleu et du proche ultraviolet (rapport 104).
- [20] R.S. HEIERSTED. Climatic Regime on Roads (rapport 410).
- [21] J.M. HAYNES, D.A. WYATT. Freezing and Melt in Small Pores (communication-intervention).
- [22] A. HOUIOU. Etude de la gélivité des bétons (rapport 205).
- [23] P.P. HUDEC. Correlation of Rock Weathering Parameters (rapport 111).
- [24] J.H. JOHANSEN. Thermal Conductivity of Soils (rapport 403).
- [25] V.N. KONISHCHEV, V.V. ROGOV, G.N. SHCHURINA. The Influence of Cryogenic Processes on Clay Minerals (rapport 105).
- [26] J.P. LAUTRIDOU. Les recherches de gélifraction expérimentale du Centre de Géomorphologie du CNRS (rapport 106).
- [27] J.P. LAUTRIDOU, L. MAZO, J.C. OZOUF, J.P. BENOIST. Etude des Mécanismes du gel dans la pierre de Caen (rapport 309).
- [28] H. LAVILLE. Aspects et nature de la gélifraction dans les abris sous roche au cours du Pleistocène (rapport 107).
- [29] R.W. MacGAW. A Proposed Clay Classification for the Texture of Frozen Earth Materials (rapport 311).
- [30] M. MASSON. Utilisation des ondes ultrasonores pour le suivi de la propagation du front de gel dans les roches carbonatées (rapport 310).
- [31] M. MAINGUET. Densité, coefficient d'usure, charge de rupture et cryoclastie dans les grès quartzites de l'Europe de l'Ouest (rapport 110).
- [32] J. MALAURIE. Eboulis superposés et changements climatiques dans le Nord-Ouest du Groenland (rapport 108).
- [33] M. MAMILLAN. Méthodes d'essais au gel de pierres (rapport 206).
- [34] M.D. MIKHAILOV. Exact Solution for Freezing of Humid Porous Half-Space (rapport 305).
- [35] M. MURESAN. Recherches expérimentales sur la gélifraction des tuiles de céramique (rapport 207).
- [36] G. MURRY. Les aciers de construction métallique utilisables aux basses températures (Exposé d'Intérêt Général).
- [37] A.D. NENNA. Utilisation du froid en médecine (Exposé d'Intérêt Général).
- [38] R. PRUD'HOMME. Influence de flux normaux sur le mouvement convectif d'interface (rapport 312).

- [39] R. ROSSET. Congélation des denrées alimentaires (Exposé d'Intérêt Général).
- [40] K.K. SRIVASTAVA, R.N. PANDEY. Heating of Moist Bodies (rapport 405).
- [41] K.K. SRIVASTAVA, R.N. PANDEY. Integral Balance Approach for Calculation of Heat Transfer Potential in Porous Bodies under Different Types of Boundary Conditions (rapport 406)
- [42] K.K. SRIVASTAVA, R.N. PANDEY. Heating of Solids of Simple Geometry when the Surrounding Temperature is a Harmonic Fonction of Time (rapport 407).
- [43] B. VALADAS. Quelques résultats d'observations de terrain en matière de gélifraction actuelle dans le Massif Central Français (rapport 109).
- [44] L.L. VASILIEV, S.V. KONIEV. Heat Pipes as Applied to Thermal Control of Frozen Ground (rapport 411).
- [45] M. VENUAT. Que savons-nous du gel du béton? (rapport 210).
- [46] Comptes rendus du VIème CONGRES INTERNATIONAL DE LA FONDATION FRANCAISE D'ETUDES NORDIQUES. Le Havre 23-25 Avril 1975. Actes et documents N° 6, Vol. 1 et 2, F.F.E.N., Paris.
- AUTRES PUBLICATIONS
- [47] J. AGUIRRE-PUENTE. Congélation des milieux poreux et problèmes posés par la gélifraction. Intenord, n° 15 (1977) Paris.
- [48] J. AGUIRRE-PUENTE, M.A. AZOUNI. Modèle théorique du passage de la glace à travers un capillaire et étude expérimentale sur membrane Réunion Commission B1 de l'I.I.F., Zürich (Suisse) 27-29 Septembre 1973. Bull. Inst. Intern. Froid Annexe 1973-4, pp. 101-113.
- [49] J. AGUIRRE-PUENTE, J.J. BERNARD. Comportement au gel des Matériaux de Construction. Séminaire sur le comportement thermique des matériaux dans la construction. Collège International des Sciences de la Construction. Saint-Rémy-les Chevreuse, 18-20 Janvier 1977 (à paraître).
- [50] J. AGUIRRE-PUENTE, M. FREMOND, G. GOMINI. Etude Physique et Mathématique du gel des Sols. Réunion Commission B1 de l'I.I.F., Washington, D.C. 14-16 Septembre 1976.
- [51] J. AGUIRRE-PUENTE, M. FREMOND, J.M. MENOT. Coupled Stefan Problem with Variable Permeability and Water Flow in Frozen Zone. International Symposium on Frost Action in Soils. Feb. 16-18, 1977 at the University of Luleå, Sweden.
- [52] J. AGUIRRE-PUENTE, B. KHASTOU, M. CHALHOUB. Etude du gonflement et de l'aspiration d'eau engendrés par le gel lors de la congélation des sols fins et humides. C.R. XIIIème Congrès International du Froid, Washington, D.C. 1971, I.I.F./I.I.R., vol.1, pp. 759-764.
- [53] J. AGUIRRE-PUENTE, M. VIGNES, P. VIAUD. Issledovanies Strukturnychizmenenij v gruntach pri promeranii (Etude fondamentale des modifications de structure observées dans les sols soumis au gel). II. Meždunarodnaja konferencija po Merzlotovedeniju. Jakutsk, SSSR 1973, Vyp. 4 : Fizika, Fizico-chimija u Mechnika Gornych Porod i L'da. str. 161-175.
- [54] CENTRE DE GEOMORPHOLOGIE DE CAEN (C.N.R.S.) Recherches de gélifraction expérimentale au Centre de Géomorphologie. Bulletins trimestriels n° 5,6,9,10,19 (1970 à 1974).
- [55] R. DEFAY, I. PRIGOGINE, A. BELLEMANS, D.H. EVERETT. Surface Tension and Adsorption. Longmans, 1966.
- [56] B.V. DERYAGIN and L.M. SHCHERBAKOV. Effect of Surface Forces on Phase Equilibria of Polymolecular Layers and on Contact Angle. Translated form Kolloidnyi Zhurnal, vol. 23, n° 1, pp. 40-52, Janvier-Février 1961.
- [57] F. FRANKS, ed.: Water. A Comprehensive Treatise, vol.1 and 5 Plenum Press, New York and London, 1975.
- [58] P. HOEKSTRA and R. KEUNE. Freezing Pressures of Clay Soils. Technical Note (informal memorandum). U.S. Army CRREL. Septembre 1966.
- [59] A. ONALP. The Mechanisms of Frost Heave in Soils with Particular Reference to Chemical Stabilisation. Ph.D. Thesis, University of Newcastle upon Tyne, Faculty of Applied Science. August 1970.
- [60] E. PENNER. Pressures Developed During the Unidirectional Freezing of Water-saturated Porous Materials. Experiment and Theory. Conference on Physics of Snow and Ice. Aug. 14-19, 1966, Sapporo, Japan, pp. 1401-1412.
- [61] T. SZANTO, J. AGUIRRE-PUENTE. Etude des caractéristiques thermiques des milieux poreux humides lors de leur congélation. C.R. XIIIe Congrès International du Froid, Washington I.I.F./I.I.R., vol. 1, pp. 751-757.
- [62] P.J. WILLIAMS. Specific Heat and Unfrozen Water Contents of Frozen Solids. Tech. Memo. 76, Assoc. Committee Soil and Snow Mechs. N.R.C. Canada, 1963, pp. 109-126.

ICE RICH SOILS AS BASES FOR STRUCTURES

V.V. Dokuchaev, A.P. Artemov and D.R. Sheinkman

Leningrad Scientific Research Institute of Experimental Design U.S.S.R.

INTRODUCTION

The strength of ice rich soils depends on their composition as well as on their temperature. This distinction is observed when the relative volume of ice which is contained in the soil in the form of inclusions π_B does not exceed a certain value, which is customarily taken to be equal to $\pi_B = 0.2$. As the ice content increases the effect of the composition of the mineral fraction of the soil on its mechanical properties decreases. For this reason the design resistances to normal pressure R , when $0.2 < \pi_B \leq 0.4$, within foundation design norms were unified. These resistances were viewed as the limits of the long term strength of soils, i.e., as the greatest stresses under which their deformations still attenuate. For ice rich soils ($\pi_B > 0.4$) this limit decreases and, as $\pi_B \rightarrow 1$, it is close to zero, for which reason the above-mentioned concept R loses practical meaning with respect to such soils. The calculated resistance for these soils should be established as the highest stress under which the deformation of the soil, during the period for which the structure is designed to be in service, will not go beyond the bounds of the stabilized flow; progressive flow is seen as an uncontrolled process which is dangerous to a foundation. Restriction of stresses to this value R is necessary but insufficient inasmuch as the constant settlement of the foundation can exceed permissible limits. For this reason it became necessary to study the deformation of ice rich soils in the presence of creep.

EXPERIMENTAL RESEARCH

The research was carried out in underground chambers which have a constant temperature regime and which are located at a depth such that

seasonal variations in air temperature have no effect. The chambers were kept at constant temperature of -1, -2, -3 and -4°C, and the humidity of the air was also kept at a high level in order to prevent the samples from losing moisture.

In order to establish the effects of ice content and texture, which is distinguished by both the size of the ice inclusions and by their distribution in the ground (uniform, layered, or in the form of a network), a large number of experiments were carried out with artificially prepared samples of soil. Data obtained in this way were supplemented by research on natural samples.

Silty sands, sandy loams ($W_L = 0.25$; $W_p = 0.18$), loams ($W_L = 0.31$; $W_p = 0.19$) and ice were studied. The techniques for preparing samples with natural and with man-made texture were developed on the basis of special experiments (Vyalov et al. 1976). The experimental research included uniaxial compressive and tensile testing of cylindrical samples ($h = 100$ mm, $d = 50$ mm), penetration of non-embedded rods ($d = 60$ mm), and also compression ($h = 30$ mm, $d = 70$ mm). The average testing times were approximately 40 days for uniaxial compression, 150 days for rod penetration, 30 days for compression testing, and a few minutes for tensile testing. The experiments were carried out both at constant loads and in incremental stages. There were no noticeable differences in the results for ice rich soils within the range of stresses tested.

The first question to which the experiments were to provide an answer was that of the magnitude of deformability of soil prior to the appearance of stabilized creep, and whether it is the deciding factor in the settlement of a foundation.

The experiments revealed that the values of the arbitrary modulus of deformation E are determined quite well by means of uniaxial compression, inasmuch as they are quite close to those obtained by means of the penetration tests; the compression tests however, despite the fact that they only reflect compaction of the soil, gave E values which were too low (this was especially noticeable for sands). High E values were obtained for all three textures.

studied and $0.4 < \Pi_B \leq 0.8$; even at a temperature of -1°C they exceeded 40 MPa. Loams with a salt content of 0.2% were an exception. Their E values were 21.6 MPa at the same temperature. It became evident from these experiments that a foundation can be allowed to carry a load under which soil creep has a non-attenuating nature.

Studies of creep were carried out on the basis of the results of uniaxial compression, in which flow at a constant rate was quite stable in time and became established after 3-4 days. Examples of creep curves for samples with $\Pi_B = 0.4$ and $\Pi_B = 0.8$ are shown in Figure 1; at $\Pi_B = 0.6$ all curves occupy an intermediate position. The established rate of deformation $\dot{\epsilon}$ as a function of the stress σ was analyzed with the aid of rheological curves, typical examples of which are given in Figure 2. It was found, for all sample types, that the initial segments of these curves are good approximations of straight lines. Similar conclusions for ice rich soils can also be drawn on the basis of the experiments of other researchers (Pekarskaya, 1961; Grechishchev, 1963). These curve segments are characterized by three parameters which are called the limit of attenuating creep σ_3 , the limit of linear creep σ_{II} , and the coefficient of linear creep $\kappa = \dot{\epsilon}/(\sigma_{II} - \sigma_3)$. The experiments confirmed that the composition of the soil does not have a significant effect on the values of σ_3 and σ_{II} . When the ice content is the same they are not significantly affected by the soil texture, the dimensions of the ice inclusions, or the method by which the sample was prepared (from a monolith or from a soil paste). The controlling factors are the temperature and the salt content of the soil. In order to confirm this, control experiments were carried out at $\theta = -4^{\circ}\text{C}$ using fine sand of basal texture ($\Pi_B = 0.4$), with a natural ice content of $Z = 0.065\%$. At a stress $\sigma = 0.05$ MPa the sand deformed at a constant rate $\dot{\epsilon} = 1.8 \times 10^{-4}$ 1/day, and no tendency toward an attenuation of the rate was observed during the course of the experiment. After desalination this same sand was found to have a value of $\sigma_3 = 0.2$ MPa.

Averaged values for the creep limits of non-salinized soils when $0.4 < \Pi_B \leq 0.6$ were found to be as follows:

Temperature, °C	-1	-2	-3	-4
σ_3 , MPa	0.05	0.10	0.15	0.15
σ_{II} , MPa	0.15	0.25	0.30	0.40

Figure 1

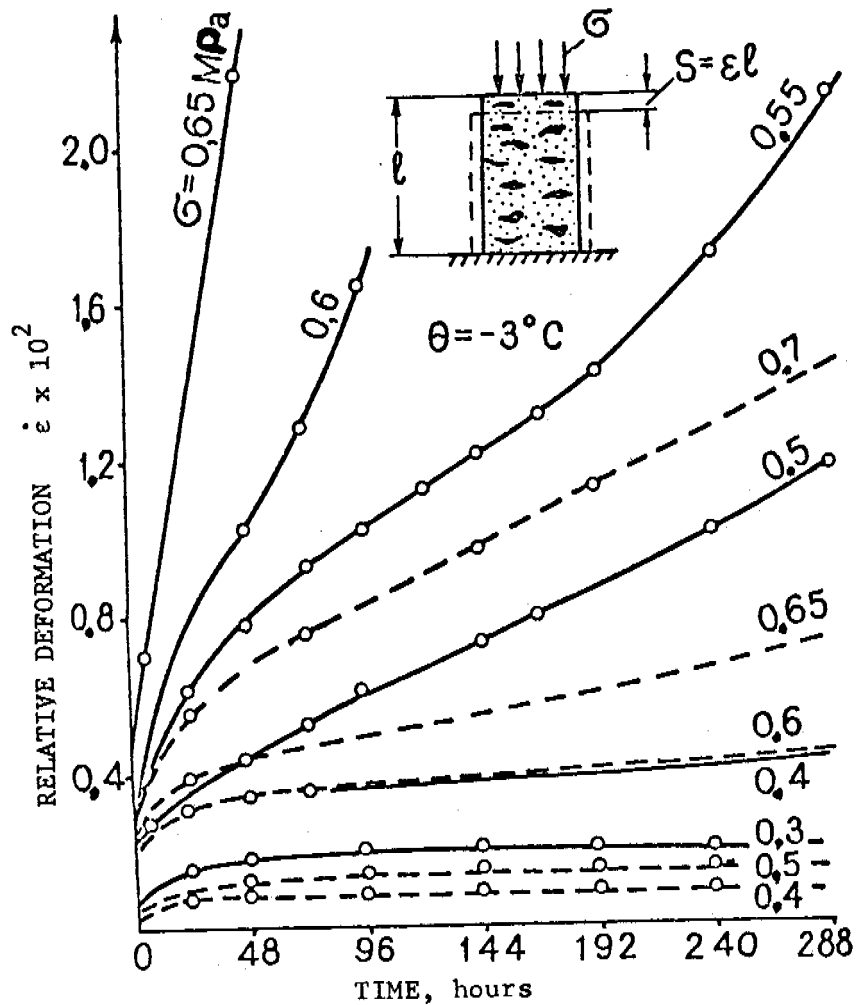

Creep curves of sandy loam with a basal texture with an ice content of $\Pi_B = 0.8$ and $\Pi_B = 0.4$ (hatched line) at various stresses.

At $\Pi_B = 0.8$ the value of σ_3 is half of that when $\Pi_B = 0.4 - 0.6$, while at $\Pi_B = 1$ it becomes practically equal to zero; the values of σ_{II} , on the other hand, change little, being quite significant and of practical interest when $\Pi_B = 1$. The relation σ_{II}/σ_3 increases with increasing temperature and ice

Figure 2

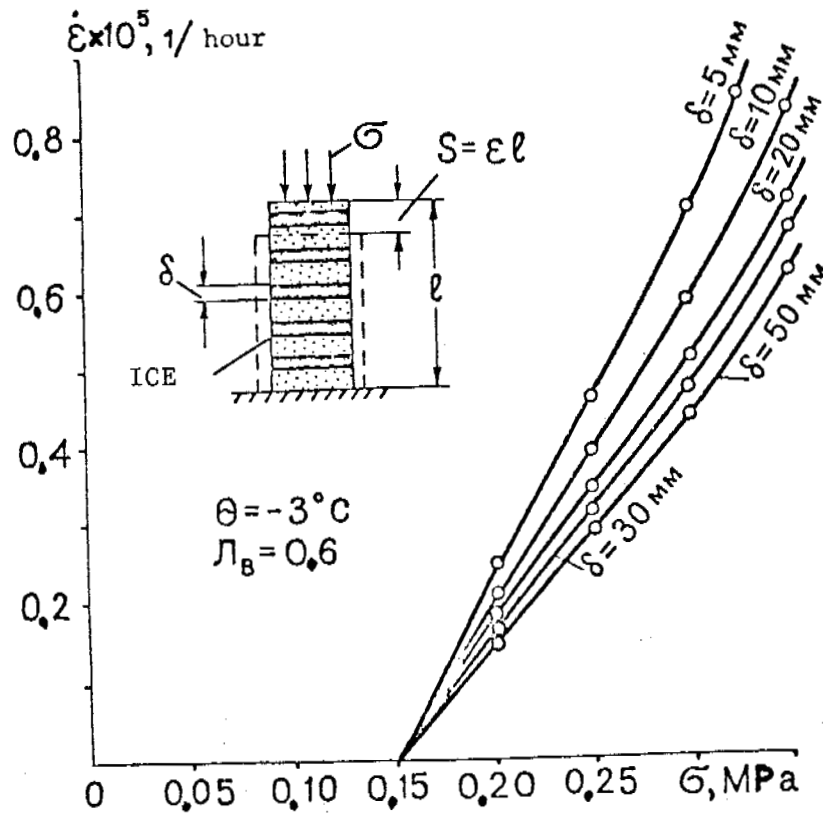

Rheological curves for loams with a layered texture.

content of the soil, i.e., when the σ values are low, and it is expedient to exceed them when deciding upon the dimensions of the base of a foundation; for example when $\theta = -1^\circ\text{C}$ and $\Pi_B = 0.8$, $\sigma_{II}/\sigma_3 > 3$.

Comparison of the σ_{II} values with the values of the calculated resistances to the normal pressure of soils with $\Pi_B = 0.2 - 0.4$ makes it possible to extend the latter to soils with an ice content of up to $\Pi_B = 1$, if the base is calculated on the basis of deformations. In this case deformation of the soils will proceed at a rate which is linearly dependent on the stress. Calculation of long term strength, with the load acting for 50 years, on the basis of experimental results also shows that conditions for the stability of a foundation are satisfied if the stresses do not exceed σ_{II} .

In contrast to σ_3 and σ_{II} , the value κ is appreciably dependent on the dimensions of the ice inclusions, the texture, and the composition of the

soil. The value κ increases somewhat as the thickness of the ice inclusions decreases, which is in agreement with earlier research. Interpretation of the results of experiments within the coordinates $\ln 1/\kappa - \ln (1 + |\theta|)$ reveals that, for ice rich soils, the coefficient of linear creep is adequately described by the known relation

$$\kappa = K/(1 + \theta)^q,$$

where K and q are parameters determined in the experiment and θ is the temperature, $^{\circ}\text{C}$.

Textural features, ice content, and salt content affect only parameter K , while parameter q depends only on the composition of the soil.

The above-mentioned principles of deformation are also observed in the case of penetrometer experiments; the initial segments of the curves \dot{S} - P (Figure 3) are of a linear nature and show the load which corresponds to σ_3

Figure 3

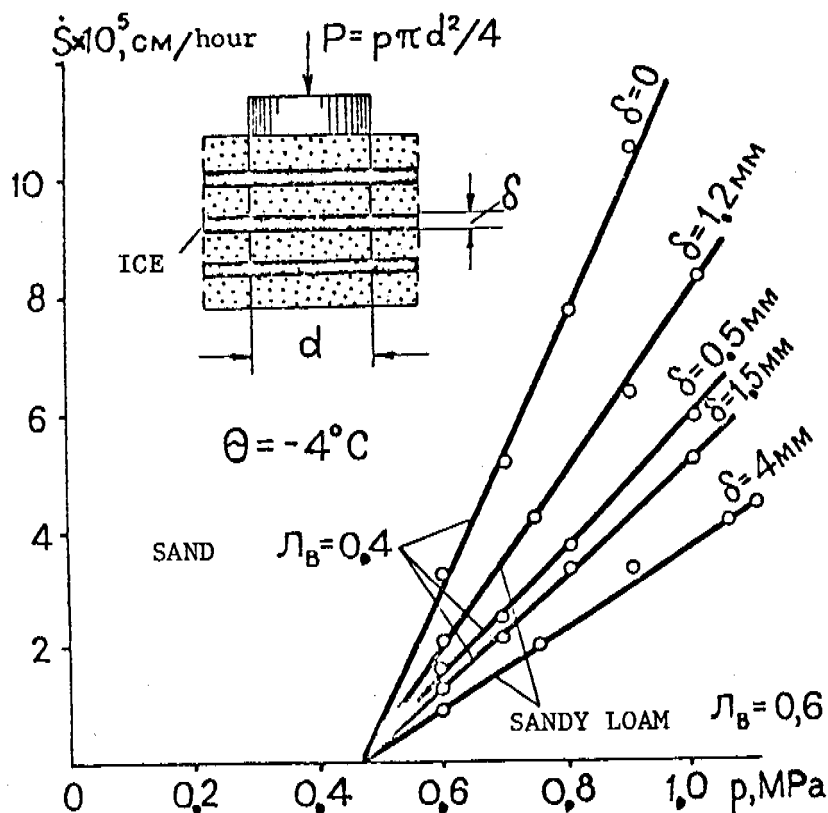

Stabilized rates of rod penetration \dot{S} as a function of the average load P

quite well. It is difficult to establish the upper limit of linear creep in these experiments because violation of the linear relation $\dot{\epsilon} - \sigma$ first occurs in a thin layer and has little effect on the overall penetration of the rod.

Tensile testing was carried out by means of the rapid application of a load and was intended to disclose the weak link in the ice-soil conglomerate. Despite differences in texture and ice content all samples, both those prepared from pastes and those from natural monoliths, broke down under the same pressure, breakdown occurring via the ice. Earlier experiments (Pekarskaya, 1961), however, showed the weak area to be the contact zone between the soil and the ice.

PENETRATION OF A ROD THROUGH A HOMOGENEOUS BASE

Calculation of the penetration of a rod which is pushed into ice rich soil can be carried out by two methods. In the first method the entire process of deformation with time is arbitrarily viewed as developing at a decreasing rate which is described by a non-linear equation of hereditary creep and which included four parameters. The reader should satisfy himself that the functions of the effect of stress, temperature and time are independent and are separated in accordance with this equation. Processing the results of the experiments which were carried out revealed that the method used to determine these parameters is also applicable to ice rich soils. Another method which has been developed further is based on the fact that the extent of penetration is most strongly affected by the creep of soil at a stabilized rate which is linearly dependent on the stress within the range $\sigma_3 < \sigma \leq \sigma_{II}$. This makes it possible to obtain an engineering solution to the problem by making use of characteristics of the soil which are determined by means of very simple experiments (e.g., by uniaxial compression). The rate of change of the angle of displacement in a simple stressed condition is

$$\dot{\gamma} = (r_{\max} - r_3) / \eta,$$

where r_{\max} , r_3 are the tangential stresses (maximum, and equal to the limit of attenuating creep); η - is the coefficient of viscosity, equal to the reciprocal value κ with an accuracy up to that of the constant factor; for uniaxial compression $\eta = 1/3\kappa$.

In the case of a complex stressed state, the condition of Roche-Huber-Mises is used, which in this case signifies that the limiting condition at the base point and in a uniaxially compressed sample occurs at the same octahedral tangential stress value.

The assumption of linear dependence between $\dot{\epsilon}$ and σ makes it possible to apply the principle of superposition in the form

$$D_{\dot{\epsilon}} = D_{\dot{\epsilon}_1} - D_{\dot{\epsilon}_2} = (D_{\sigma_1} - D_{\sigma_2})/2n,$$

where $D_{\dot{\epsilon}}$ and D_{σ} are the deviators of the rates of deformations and stresses, index 1 denoting those values of them which are the result of load applied to the boundary of the half-space, and index 2 denoting the same in an arbitrary stresses state which corresponds to the limit of attenuating creep.

The first component, on the basis of Hencky's relation, is

$$\dot{\epsilon}_{1z} - \dot{\epsilon}_{1cp} = (\sigma_{1z} - \sigma_{1cp})/2n,$$

where $\dot{\epsilon}_{1z}$ and $\dot{\epsilon}_{1cp}$ are the rate of deformation along the z axis and the rate of volumetric deformation; σ_{1z} and σ_{1cp} are the normal to the z axis and the mean stress.

The mean deformation depends on Poisson's ratio, whose value in the stage of creep at a stabilized rate is close to 0.5 (Tsytoovich, 1973; Vyalov et al. 1967). For this reason it may be assumed that compaction of the soil is completed during the stage of non-stabilized creep, while for the stage under discussion $\epsilon_{cp} = 0$.

With these premises the rate of deformation of the foundation is

$$\dot{\epsilon}_z = (\sigma_z - \sigma_{cp} - R_3)/2n,$$

where R_3 is the limit of attenuating creep for the base, whose value with an accuracy up to that of the constant factor is equal to the analogous limit established on the basis of laboratory testing of the soil, for example by uniaxial compression (in this case $R_3 = 2\sigma_3/3$).

The rate of settlement of a layer of foundation $z_2 - z_1$ in thickness is

$$\dot{S} = \int_{z_1}^{z_2} [(\sigma_z - \sigma_{cp} - R_3)/2\eta] dz.$$

The ordinates of the boundaries of the z_1 and z_2 layer are found by virtue of the trinomial in the round brackets being equal to zero. Secondary integration of this expression with respect to time gives the desired value for the settlement of the layer.

In the case of a homogeneous foundation and constant soil temperature the rate of penetration of a rod of diameter b and an average pressure p at its base is

$$\dot{S} = [pb(\omega_2 - \omega_1) - 0.5R_3(z_2 - z_1)]/\eta,$$

where

$$\omega_2 = 0.5 \int_0^{\bar{z}_2} \frac{\sigma_z - \sigma_{cp}}{p} dz; \quad \omega_1 = 0.5 \int_0^{\bar{z}_1} \frac{\sigma_z - \sigma_{cp}}{p} dz; \quad \bar{z} = z/b.$$

The values of z_1 , z_2 , ω_1 , ω_2 may be found from the monogram (Figure 4), on which arrows are used to show an example of how the values are to be determined.

Settlement of a foundation is affected by the shape of its base, and also by non-homogeneity. These factors were studied as per the example of a non-embedded rod pushed into ice (Vyalov et al. 1976). It was established that when ice is deformed under conditions of linear creep foundations which are square and round in plan exhibit practically the same settlement. Depending on the thickness of the deforming layer, the relation of established rates of settlement of foundations, calculated on the basis of an elastic and a rigid rod scheme, are within the limits of 1.4 (when $\bar{z}_1 = 0$; $\bar{z}_2 = 2$) to 1.3 (when $\bar{z}_1 = 0$; $\bar{z}_2 = 6$) for a round foundation and, correspondingly, 1.25 to 1.15 for a rectangular foundation.

For layered foundations, represented by ice rich soils and ice, the relation of the moduli of deformability E_{rp}/E_{II} is reduced to the relation of

Figure 4

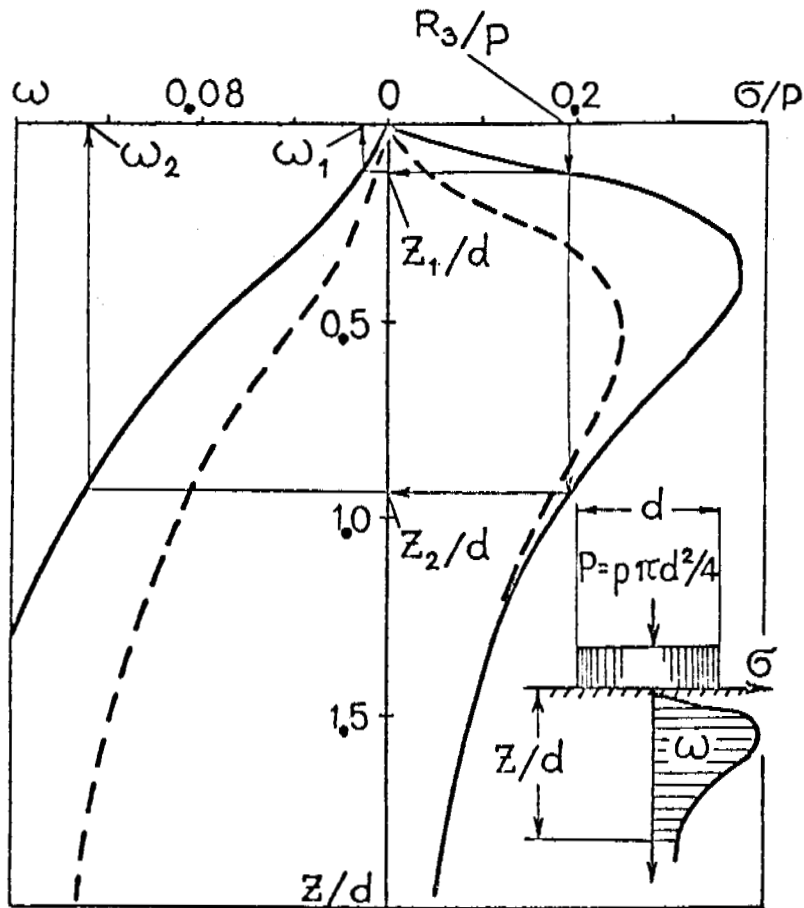

Nomogram for determining z_1 , z_2 and ω_1 , ω_2 for round elastic and rigid (hatched line) rods.

their coefficients of viscosity. It was established that non-homogeneity of the foundation significantly affects the extent of settlement. For example, when the thickness of the soil layer is $0.5b$ and the thickness of the underlying layer of ice is $5.5b$ the change in the relation E_{rp}/E_{II} from 1 to 20 results in a corresponding decrease in the magnitude of the settlement of viscous flow by approximately 2 times. When $E_{rp}/E_{II} > 1$, however, there arise in the soil significant horizontal tensile stresses which it cannot absorb, for which reason increased rigidity of the upper layer should not be taken into account in practical calculations. The presence of a rigid layer which underlies the ice layer does not have a noticeable effect on settlement if the thickness of the ice layer exceeds the width of the rod by two-three times.

Comparison of the values of stabilized rod penetration rates as recorded in experiments \dot{S}_0 and as obtained through calculations \dot{S}_p (using

creep characteristics determined by uniaxial compression experiments) shows satisfactory agreement, as may be seen from the table, which gives their values for soils with an identical ice content $\Pi_B = 0.6$, but with different thicknesses of the interlayers δ .

Soil	P, MPa	$\dot{S} \times 10^5$, cm/hour	
		\dot{S}_0	\dot{S}_p
Sand, $\delta = 0.5$ mm	0.7	2.5	2.7
	0.8	3.8	4.1
Sand, $\delta = 1.5$ mm	0.7	2.1	2.6
	0.8	3.4	3.9
Sandy loam, $\delta = 1.2$ mm	0.9	6.25	6.3
	1.05	8.3	8.6
Sandy loam, $\delta = 4$ mm	0.9	3.2	2.9
	1.05	4.1	3.9

A PRACTICAL METHOD OF CALCULATING THE SETTLEMENT OF A FOUNDATION

A practical method of calculating the settlement of the base of a columnar foundation can be reduced to the determination of the rate of settlement per year, which is determined as the sum of the monthly rates of settlement v_j . To calculate v_j the method of summing the rates of settlement of layers of thickness h_i is used. The base is subdivided into such layers in order to make it possible to calculate, with little error, the soil temperature constant in each layer at the given instant; this is equivalent to averaging the creep parameters η_i , R_{3i} over the thickness of the i -th layer (Figure 5).

The monthly rate of settlement in this case is

$$V_j = \sum_{i=1}^n V_i = \sum_{i=1}^n (\sigma_i - R_{3i}) h_i / 2\eta_i,$$

where

$$\sigma_i = \sigma_{zi} - \sigma_{cpi} = \alpha_i p$$

Figure 5

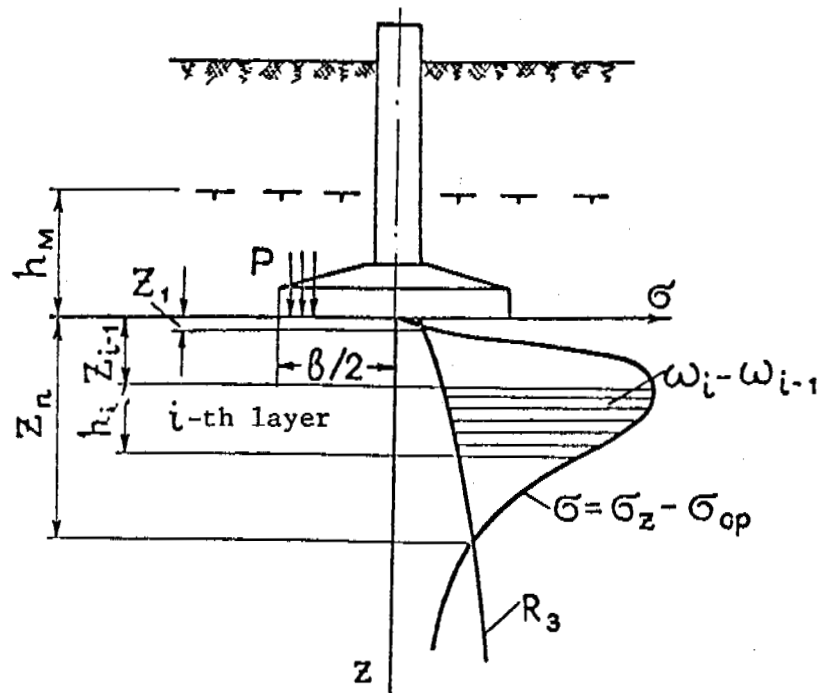

Schematic diagram for computing the base.

The coefficient α_j is obtained from a table in another paper (Vyalov et al. 1976), while p is determined as the pressure on the base of the foundation, transmitted by the structure, minus the pressure created by the soil. The thickness of the i -th layer can usually be taken to be $h_i \leq 0.4$.

Instead of averaging the stresses σ_j by layers it is possible to use the areas under their curves. In this case

$$V_j = \sum_{i=1}^n [pb(\omega_i - \omega_{i-1}) - R_{3i}h_i/2] \eta_i.$$

The coefficients are obtained from a graph (Figure 6); similar graphs have been compiled for loads which are distributed in a different manner, as well as for points along the perimeter of a base. This form becomes particularly convenient in the case of ice since $R_{3i} = 0$.

Figure 6

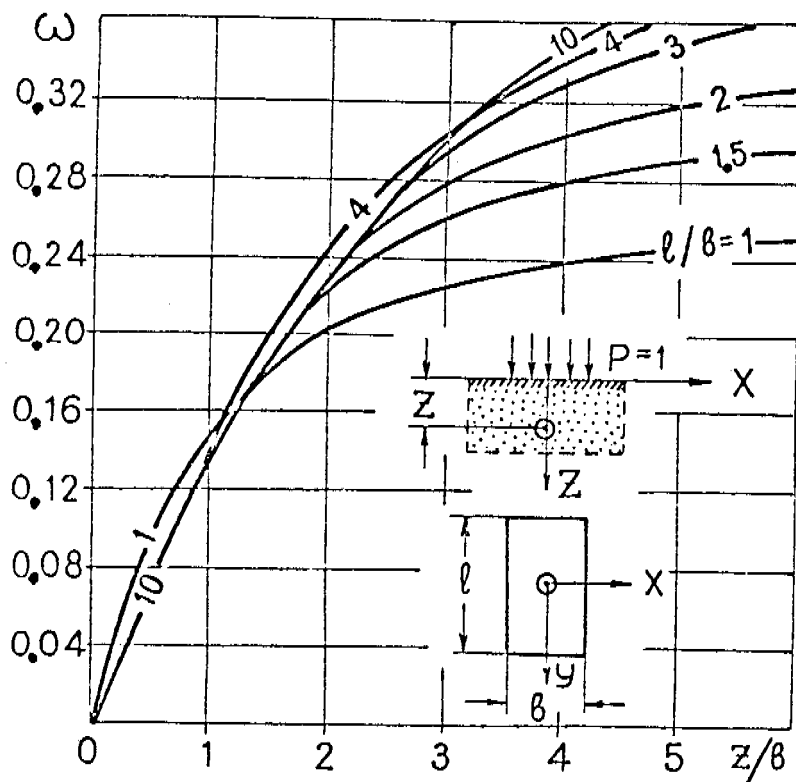

Graph for determining the ω coefficients.

In order to determine n_i and R_{3i} the mean monthly temperatures we have

$$\theta_{ji} = \alpha_{ji} K_{\theta} \theta_0,$$

where α_{ji} is a dimensionless coefficient determined for the j -th month and the i -th layer, the middle of which is at a depth $h_m + z$ from the upper surface of the permafrost; K_{θ} is the coefficient of the thermal effect of the structure on the mean annual temperature of the permafrost θ_0 , as determined in the usual manner. The coefficient α_{ji} depends on the thermophysical properties of the soils, although for ice rich soils these properties do not differ much from the mean values, which makes it possible to represent the coefficient α_{ji} as a function of only the given depth and the time of year.

Limitation of the pressure on the base is reduced to compliance with the condition $\sigma_i < 2R_{II}/3\kappa_H$, where R_{II} is established on the basis of uniaxial compression testing and κ_H is the coefficient of reliability, which may be assumed to have a value of 1.

Figure 7

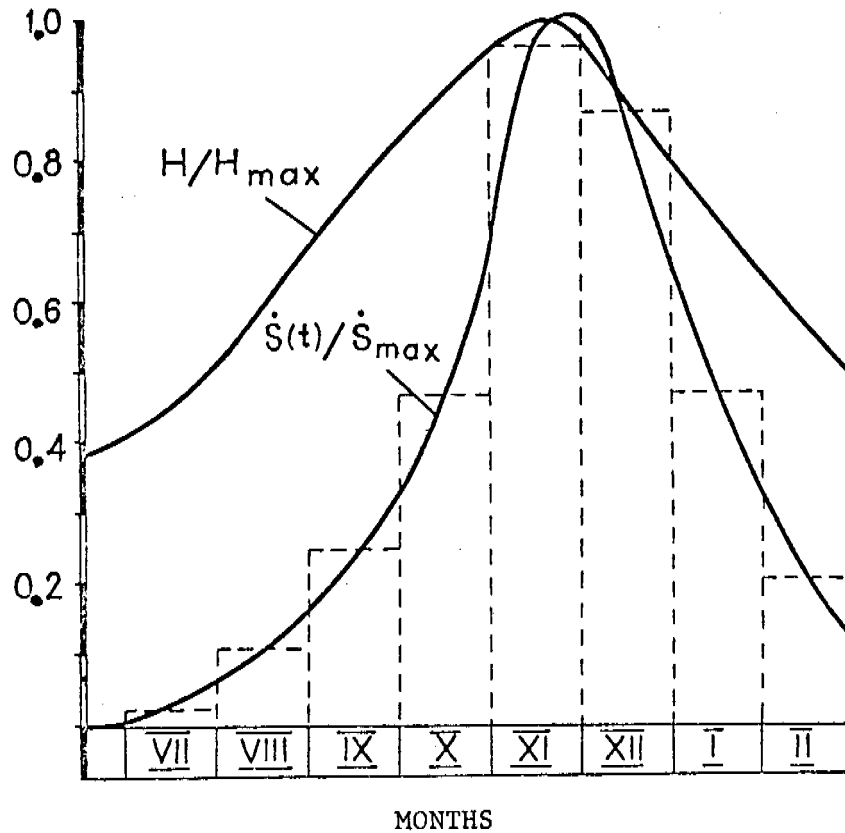

Relative values of foundation settlement rates $\dot{S}(t)/\dot{S}_{max}$ and of the thickness of the deforming layer H/H_{max} .

Calculations show that deformations of ice rich soils attenuate at very shallow depths, inasmuch as σ rapidly diminishes with depth, while n and σ increase. The accumulation of settlement during the course of a year (Figure 7) proceeds unevenly and it is sufficient in calculations to consider only a few months during the course of which seasonally thawed layers exist. When complete use is made of the calculated resistance of soils, settlement of the base can approach and even exceed the settlement limit. In order to bring the expected and limiting settlement into agreement it is advisable to install soil pads beneath foundation bases.

CONCLUSIONS

Calculations of expected deformations, as well as actual experience with buildings built on sites having ice rich soils or ground ice reveal that these can serve as reliable foundations. This conclusion can be extended to pile foundations also, for which the method of calculating settlement is in the development stage. Meanwhile, pile foundations are designed using estimated resistance values which are known to guarantee low rates of deformation, which results in settlements significantly below the limits for buildings of all design types.

REFERENCES

- VYALOV S.S., DOKUCHAEV V.V. and SHEINKMAN D.R. Ground ice and ice rich soils as foundations for structures. Leningrad, "Stroiizdat", Pub. 168 pages, 1976.
- VYALOV S.S., GORODETSKII S.E. and others A method for establishing the creep, long term strength and compressibility characteristics of permafrost. Moscow, "Nauka" Pub. 132 pages, 1966.
- VYALOV S.S., SHUSHERINA E.P. and GORODETSKII S.E. Principles of the deformation of permafrost in the simple and complex stressed states. In the book: Permafrost Research and Problems of Construction. Syktyvkar, KOMI KIZ, pp. 61-69, 1967.
- GRECHISHCHEV S.E. The creep of permafrost under complex stress. Pub. of the Siberian Branch of the Academy of Sciences U.S.S.R., pp. 55-124, 1963.
- PEKARSKAYA N.K. Resistance to displacement of permafrost with various textures and ice content. In the book: Research into the Physics and Mechanics of Permafrost. Pub. of the Academy of Sciences U.S.S.R., No. 4, pp. 166-186, 1961.
- TSYTOVICH N.A. The mechanics of permafrost. Moscow, "Vysshaya Shkola" Pub. 448 pages, 1973.

PROBLEMS AND POSSIBILITIES OF STUDYING THE PROCESSES OF
DYNAMIC RELAXATION IN FROZEN EARTH MATERIALS

A.D. Frolov

Moscow Geological Survey Institute, U.S.S.R.

The expanding assimilation of territories with severe climatic conditions brings to the fore, among the most important scientific problems, an intensive development of the physics of frozen earth materials as a basis for the resolution of numerous applied technical and engineering-geological tasks in the prospecting, planning, construction and exploitation of various kinds of structures. It is necessary to develop such specializations during the development of which it would be possible to obtain the greatest amount of comprehensive information on the nature of the formation of the physical properties of frozen earth materials and of the mechanisms of the course of the physical and physico-chemical processes in these materials. Optimal in this plan would be studies in various physical fields in which the processes of the excitation of the object, the reception of the signals from it and the decoding of these signals would be unified and at the same time would be most effective for obtaining information on the internal processes in such complex media as frozen earth formations.

In view of the fact that a characteristic feature of frozen earth and many polycrystalline ice formations is their heterogeneity and multiphased nature, one of the optimal specializations in the physics of these media, in our opinion, is the comprehensive study of relaxation processes. Data attained in the course of such investigations of this type, characterizing the kinetics of the internal changes in the studied material, associated with responses to external influences or with a transition into a quasi-equilibrium state, often provide unique information on the internal structure and composition of the studied material and on the patterns and mechanisms of the physico-chemical transformations occurring within it.

In the physics of various condensed media (Mikhailov et al., 1964; Bartenev, 1972; Postnikov, 1974) the fruitfulness and effectiveness of this direction of study have already been fairly convincingly demonstrated.

In order to reveal some of the prospects for the development of the physics of relaxation phenomena in frozen earth materials and, especially, for investigations of dynamic relaxation, we will briefly consider the characteristic features of frozen earth materials as condensed media, the fundamentals of the physics of relaxation processes and some results of the study of these in cryogenic formations.

CHARACTERISTIC FEATURES OF FROZEN EARTH MATERIALS AS CONDENSED MEDIA

We will consider in a generalized way some of the characteristic features of frozen earth materials on the basis of information attained in permafrost studies (Dostovalov and Kudryavtsev, 1967; Savel'ev, 1971; Tsytovich, 1973; Vyalov, 1973; Kudryavtsev et al., 1974; Mel'nikov et al., 1974) and physico-chemical mechanics (Rebinder and Shchukin, 1972).

Frozen earth materials and polycrystalline ice of various composition are, in the general case, heterogeneous multiphased and multicomponent macrosystems. A characteristic feature of these is the formation of a new cryogenic coagulation-crystallization spatial structure (Votyakov, 1975; Frolov, 1976). The principal elements of this spatial structure are: a) granules (sometimes also streaks) of ice; b) granules of the mineral skeleton; c) intergranular boundary zones, including cells (films) of unfrozen water and gas (with incomplete water saturation of the pores), admixtures and transitional layers of ice granules. The interaction (contacts) between the particles of this type of structure may be of two basic types (Rebinder, 1966):

Coagulation contacts, dependent on fairly long-range forces, generally effected through the thin equilibrium layer of the liquid phase. These may be re-established after breakdown (thixotropy), their bonding energy is approximately equal to $\sim kT$, while their bonding force is approximately equal to $\sim 10^{-5} - 10^{-7}$ dynes. The consolidation and desiccation

of such structures is accompanied by a displacement of the liquid from the contact zone and the appearance of point ("atomic") contacts between granules of the solid phase.

At temperatures close to the melting point of the material of the solid component (in our case - ice) the processes of volumetric and surface diffusion are intensified, as a result of which the contact surface of the particles may become expanded into a "phase area", considerably larger than the cross-section of an elementary cell of a crystal.

Phase contacts, dependent on short-range forces within considerable areas of the separation of the phases. These are broken down irreversibly; the bonding energy is much greater than $\gg kT$, while the bonding force is approximately equal to $\sim 10^{-4} - 10^{-3}$ dynes. Dispersed structures with phase contacts possess considerably greater strength and stability, and approximate polycrystals in their properties. The adhesion of particles in aqueous media depends on the composition and concentration of the electrolyte, and on the charge of the ions. Initially an increase in the concentration of the electrolyte, with a filling up of the adsorption layer, leads to a decrease of the adhesion forces but, subsequently, as a result of the degradation of the diffusion part of the double layers, adhesion increases. It is assumed that electrolytes and surface-active substances (SAS) affect the adhesion of the particles to the extent that they change the distance between contacting surfaces and the degree of order of the boundary layer. Disorienting SAS allow adhesion to be increased, since these substances depress the shielding effect of the liquid boundary layer, while SAS which facilitate the formation of ordered boundary layers decrease the adhesion between solid particles.

Crystallization structures. These types of structures are formed during the crystallization of a new phase in the gaps between the dispersed particles of the medium. In frozen earth materials the new phase is ice and crystalline hydrates of salts. Crystallization phase contacts are formed as a result of the accretion of crystals with random orientation and are characterized by a non-equilibrium state, i.e., changes in the properties of such a structure with time are possible. In particular, there is noted a

decrease in the strength, associated with the recrystallization and dissolution of uneven and small formations of the new phase. The interaction of the particles of the dispersed phase is dependent also on the state of their surface and on the degree of their activation, i.e., there is possibly a considerable residual effect of the mechano-chemical factors which take part in the process of the formation of the particles of the soil skeleton. The effect of the adsorption layers of liquid ("unfrozen water") is twofold. On the one hand, these impede the development of phase contacts, i.e., they depress the cohesion of the material, while, on the other hand, at a certain thickness of the layers the SAS condition an increase in the cohesion of the spatial structure on account of the plasticity of the adsorbed layer.

According to the type of structure of the heterogeneous medium the frozen earth materials may contain both almost isolated inclusions of components and also an interpenetrating distribution of these, i.e., they typically have complex combined types of structures and a distribution of bonds between the particles associated with their energies. Therefore, the theoretical models of granular and capillary media, that are known in the literature, are inadequate for frozen earth materials and it is difficult to represent these as a model.

The component composition of frozen earth materials may be schematically represented by means of a three-dimensional diagram (Figure 1) with the following coordinates: volume of earth material - V , total moisture content - W_v , and temperature - t , $^{\circ}\text{C}$. Changes in the composition may be characterized by Kedzi's indices:

$$V_{sk} + V_i + V_{uw} + V_g = 1, \quad (1)$$

where V_{sk} , V_i , V_{uw} and V_g - respectively, are the volumes of the skeleton, ice, unfrozen water and gas in a unit volume of the earth material, which latter should be chosen sufficiently large to ensure good representation of the indices, taking into account the non-homogeneity of the given cryogenic texture and structure.

As follows from the diagram, a change in Kedzi's indices for frozen earth materials with a given composition of the skeleton and a certain

initial porosity (in Figure 1 this is taken to be 40%) may occur in two ways:
 a) with $V_{sk} = \text{constant} \neq 0$ - partial moisture saturation, constant porosity;
 b) with $V_g = 0$ - complete moisture saturation, variable porosity.

Figure 1

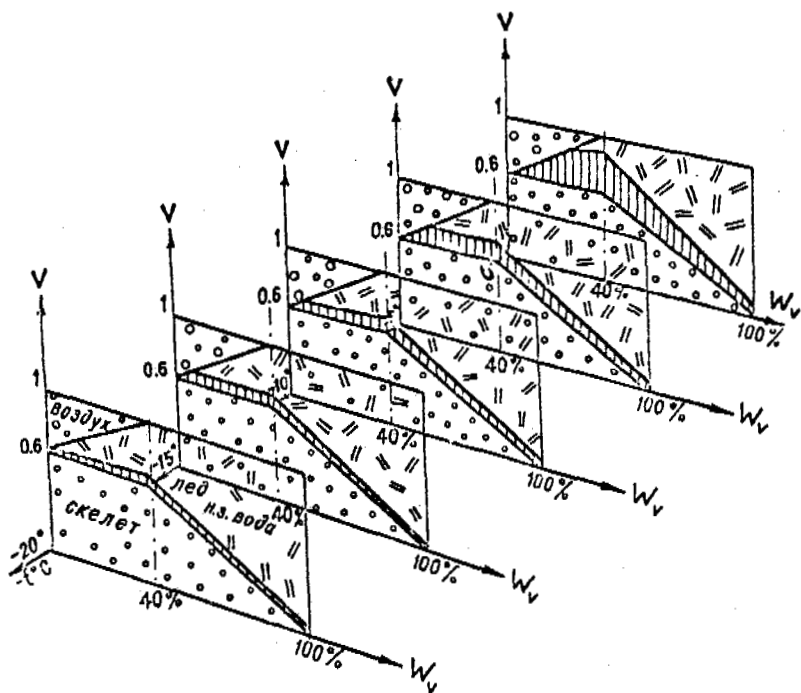

Schematic diagram of the component composition of frozen earth materials.

In the first case the frozen earth material is a four-component macrosystem in which, as the ice content increases, there also occurs an increase in the content of unfrozen water. In the second case this is practically a three-component system in which, with an increase in the total volumetric moisture content W_v and, consequently, also in V_f , there occurs a decrease in V_{sk} and V_{uw} , attaining minimal values in the limiting state, corresponding to polycrystalline ice. Variations in the composition of the frozen earth materials should lead to particular changes in its physical properties. At the same time there are grounds for assuming that a change in the phase composition of H_2O will manifest the greatest effect on the electrical and the mechanical properties and also on the course of the mixed mechano-electrical phenomena.

It should also be kept in mind that a change in the volumetric content of the components also leads to a particular change in their properties, especially of the unfrozen water and, in part, of the ice. For example, in step with the freezing out of the liquid phase the concentration of the non-crystallizing pore solution increases, its structure changes, and the growing boundary layers of ice, apparently, will contain larger admixtures. The patterns of these changes are still unknown and are not easily accessible to experimental studies, though there is no doubt that they lead to changes in the physical properties of the earth materials. For frozen earth materials, therefore, there are scarcely applicable the various types of models which are based on the additive properties of the components and which take into consideration only the variations in the composition of the mixture, the packing of the particles, etc.

Of course, the diagram presented here does not reflect the peculiarities of the spatial distribution of the ice and of the unfrozen water, nor of the occurring cryogenic system of pores, capillaries and other elements of the supramolecular and supracrystallite macrostructure. Meanwhile, not infrequently it is namely these elements (and not the material composition of the earth), their structure, distribution in space, composition and interrelationship which determine the formation and change of the physical (especially of the electrical and of the mechanical) properties of the frozen earth materials as composite materials. Of very important significance, therefore, is the consideration of the processes of formation and specific evolution of the spatial cryogenic structure of crystallization and coagulation (Frolov, 1976a). Because of the fact that the "active" surface of the granules of the solid phase is non-homogeneous, in the formation of this spatial structure the non-compensated charges and other defects are not evenly distributed, there occurs an insular character of adsorption of water and ions of the pore solution, and, consequently, a non-homogeneity of the structure of the liquid phase in the double layers. In the process of adsorption there also occur distortions of the crystalline lattice of the near-surface layer of the granules of the solid phase, which in turn create additional non-homogeneities in the field of the adhesion forces of the granules. Therefore, there should occur a distribution of the intergranular contacts and boundary zones of the frozen earth materials

according to the size of their strength, which leads to concepts of a sequential (commencing from the least strong) breaking of the contacts in the field of mechanical stresses. Under certain conditions such a mechanism may cause a partial relaxation of the stresses and, consequently, an attenuation (stabilization) of fracture-formation and a certain strengthening, which is corroborated by special studies on frozen earth materials (Vyalov, 1959, 1973). Destruction of such a medium will occur only when the average load per contact will prove to be equal to the average strength of the undisturbed contacts. The elasticity of frozen earth materials is also determined by the properties of the spatial cryogenic texture and should increase with an increase in the rigidity of the latter, i.e., with the hardening of the liquid phase with a drop in temperature. Thus, in the process of the evolution of the spatial structure and of the change in the component composition during the freezing or the thawing of the frozen earth materials, there should occur a characteristic interrelated change in the mechanical and electrical properties. For example, with a drop in the temperature of frozen sandy-clay earth materials (i.e., with the decrease of the volume of the unfrozen water, of the mobility of the admixtures and defects, of the dimensions of the mobile defects and, as a whole, of the plasticity of the boundary zones and ice granules) there should occur an increase in: the elasticity, the strength, the relaxation time, the electrical resistivity, etc., and there should also occur a decrease in: the dielectric constant, the polarization capacity, the plasticity of the earth materials, the intensity of the mechano-electrical and electro-kinetic phenomena, etc.

FUNDAMENTALS OF THE PHYSICS OF RELAXATION PROCESSES

In a first approximation any process of relaxation in a macrosystem may be represented as occurring in two stages: 1) the establishment of quasiequilibria in small parts of the system (rapid processes), and 2) the balancing of the parameters of the state in all parts of the system (slow processes). The latter is associated with a large number of interactions and transformations of the parts of the macrosystem, and the time of relaxation is proportional to the dimensions of the macrosystem.

Mechanical, electrical, magnetic and thermal relaxation are distinguished and it is considered that these are accompanied by

characteristic changes of the corresponding physical properties, which view is to some degree arbitrary, since, strictly speaking, with any external effect there occurs a relaxation of almost all of the physical and physico-chemical parameters of the system. The aims of investigations are to study in detail the patterns of variation of the parameters of the physical properties and their integration, i.e., to establish the relationships with the internal transformations occurring in the macrosystem. More promising are comprehensive studies of the relaxation in two or several force fields, and also studies of the variations of different physical and physico-chemical parameters under the influence of a field of one type.

The course of the relaxation processes essentially depends on the character of the changes of the effective field in time and in space. The simplest (and at the same time most important from the practical aspect) cases of change of the field in time are the pulsed ("static") and periodical ("dynamic") relaxation, while in space the simplest case is plane relaxation. With static relaxation there occur in the medium processes of hysteresis and a regular relaxation of the force characteristics of the field (stresses, tension, etc.). With dynamic relaxation, generally considered in harmonic fields, there occurs a characteristic dispersion of the parameters of the properties of the medium and an absorption of the energy of the effective field. The study of the patterns of the corresponding relaxation processes allows one to determine the properties of materials, that are needed for practical purposes, and helps one to gain an understanding of the nature of their formation with variations in the composition and state of the studied medium. The theory of various kinds of relaxation of macrosystems has attained considerable development (Mikhailov et al., 1964; Postnikov, 1974).

In the study of the properties of frozen earth materials investigations of a change in the effective field in a pulsed or pulsed-like regime have become widespread. Thus, the widely known studies of the mechanical (N.A. Tsytoovich, S.S. Vyalov, K.F. Voitkovskii and others), electrical (V.P. Mel'nikov, E.S. Fridrikhsberg, M.P. Sidorova and others) and thermal (I.N. Votyakov, S.E. Grechishchev, E.P. Shusherina and others) hysteresis and relaxation of the force characteristics of fields and also of the corresponding deformations in the medium have expanded our knowledge of

the patterns of the formation of the properties and processes of the physico-chemical transformations in frozen earth materials. However, in the studies of slow relaxation processes the obtained values of the parameters of the physical properties represent an integral effect of many mechanisms and are essentially dependent on the scale factor (the volume of the studied sample, monolith, etc.), which is often not possible to take into account. Therefore there arises the question of the representative nature of the determined "static" characteristics as parameters of the corresponding physical properties (elasticity, permeability, etc.) (Bogorodskii et al., 1971; Frolov, 1976b).

Meanwhile, there exists the possibility for determining the parameters of the physical properties of frozen earth materials in a "purer" form. This consists of the measurement of the dynamic properties in periodically changing fields, i.e., the study of the processes of dynamic relaxation. In this case there are extensive possibilities for varying the intensity and frequency of the effective fields, which favours the separation of the effect of individual mechanisms on the studied properties. In the study of dynamic relaxation it is easier to accomplish comprehensive investigations with the simultaneous effect of several different force fields, or of fields of one type but of varying intensity, frequency of polarization, etc. The values of the dynamic parameters of the physical properties obtained in situ and for samples are found to be more comparable. Showing promise in the investigation of frozen earth materials is the combined study of dynamic electrical and mechanical relaxation, since it is namely the parameters of the electrical and mechanical properties that are found to be most sensitive to changes in the phase composition (Frolov, 1976a).

An analysis of the phenomenological theory of mechanical and electrical relaxation shows that from the aspect of the cause-effect relationship the form of the laws, determining the reaction of the medium to the mechanical and to the electrical effect, is completely the same. Thus, for "instantaneously" responding (ideal) media these laws are represented by the linear equations:

$$D_i = \epsilon_{ij} \cdot E \quad i, j = 1, 2, 3 \quad (2)$$

$$\epsilon_{ljm}^M = S_{iklm} \cdot \sigma_{ik}; \quad i, k, l, m = 1, 2, 3 \quad (3)$$

$$\sigma_{ik} = C_{iklm} \cdot \epsilon_{lm} \quad (4)$$

These are known laws establishing the relationship between the characteristics of the electrical, D , and the mechanical, ϵ^M , disturbance (response of medium) and the force characteristics of the effective fields: the tension E and the mechanical stress σ . The difference consists only in the rank of the tensors of the parameters of the properties: the dielectric constant ϵ_{ij} and the coefficient of mechanical compliance S_{iklm} (or the modulus of elasticity C_{iklm}), which leads only to a difference in the number of terms in the linear equations. Thus, for quasi-isotropic ideal media equations (2 - 4) take on the form:

$$D = \epsilon \cdot E \quad (2')$$

$$\epsilon_{lm}^M = \frac{1}{2} S^* \sigma_K + \left(\frac{1}{9} S - \frac{1}{6} S^* \right) \sigma_{ll} \cdot \delta_{ik} \quad (3')$$

$$\sigma_{ik} = K \epsilon_{ll}^M \cdot \delta_{ik} + 2G \left(\epsilon_{ik}^M - \frac{1}{3} \epsilon_{ll}^M \delta_{ik} \right) \quad (4')$$

where K and G - moduli of all-round compression and shear, $S = 1/k$, $S^* = 1/g$, δ_{ik} - Kroneker's symbol. From equations (2' - 4') there is evident the similar role of the parameters of the dielectric constant ϵ and the mechanical compliance (shear S and volumetric S^*) are evident. Therefore, for example, with a change in the composition or state of the material they should change in a similar fashion. The patterns of the corresponding changes of the moduli of elasticity should, on the whole, be reversed. In most cases, however, frozen earth materials do not approximate ideal (elastic or polarizing) media, i.e., they are not characterized by an instantaneous reaction to an effect. This means that in a force field there will occur processes with certain finite times of relaxation. Then the considered laws (2') - (4') should be presented in the form of the integral expressions:

$$D(t) = \int_{-\infty}^t \epsilon(t, \tau) \frac{dE(\tau)}{d\tau} d\tau \quad (5)$$

$$\epsilon_{ik}^M(t) = \int_{-\infty}^t S_{iklm}(t, \tau) \frac{d\sigma_{lm}(\tau)}{d\tau} d\tau \quad (6)$$

$$\sigma_{ik}(t) = \int_{-\infty}^t C_{iklm}(t, \tau) \frac{d\epsilon_{lm}^M(\tau)}{d\tau} d\tau \quad (7)$$

which are easily reduced to the linear equations (2' - 4') by inserting in place of the parameters of ϵ , S and C operators of the form $\int_{-\infty}^t \epsilon(t, \theta) d\theta = \epsilon$ and correspondingly for S and C .

For the case of dynamic relaxation in harmonic fields the integration of equations (5 - 7) and the transition from a time-dependent to a frequency-dependent relationship leads to equations for complex parameters (permeability, moduli of elasticity and compliance), expressed by means of distribution functions of the probability density of the times of (electrical or mechanical) relaxation. Moreover, for the complex $\tilde{\epsilon}(\omega, \theta)$, $\tilde{S}^*(\omega, \theta)$, $S(\omega, \theta)$ there are obtained quite similar expressions of the form:

$$\tilde{a}(\omega, \theta) = a_1 - ja_2 = a_\infty + \int_0^\infty \frac{F(\theta) d(\theta)}{1 + j\omega\theta} \quad (8)$$

while for the moduli of elasticity - as the reverse values:

$$\tilde{b}(\omega, \theta) = b_1 - jb_2 = b_0 + \int_0^\infty \frac{F(\theta) j\omega\theta}{1 + j\omega\theta} \quad (9)$$

The distribution function of the probability density $F(\theta)$ may, in the general case, be independent for each of the parameters. The real parts of the parameters characterize the polarization capacity and elasticity of the medium, while the imaginary parts characterize the absorption of the energy of the force field because of the non-ideal nature of the medium.

From expressions (8 - 9) it follows that in a non-ideal medium there should be a frequency dispersion of the parameters of its mechanical and electrical properties, conditioned by the presence of finite relaxation times of the corresponding processes. The character of this dispersion will depend on the type of distribution of the relaxation times. In the literature the patterns of mechanical and electrical relaxation are generally considered separately on the basis of particular models of the mechanisms of polarization and deformation. The consideration presented above graphically demonstrates the similarity of these processes and the advantage of studying them in combination. Furthermore, there are indications that for several materials, in particular for ice, there has been established a close similarity of the effective times of mechanical and electrical relaxation,

which indicates the presence of profound interrelationships between the mechanisms of these processes. In the simplest cases, when the relaxation process in the material may be described by one relaxation time, equations (8) are transformed into the well-known equations of Debye, while equations (9) are transformed into the equations obtained in the calculation of the viscosity, the thermal conductivity of the medium or the Knezer effect, etc. In the presence of several relaxation mechanisms, i.e., a distribution of the relaxation time, for some typical particular cases (symmetrical and asymmetrical distribution) there are obtained equations of the interrelationship of the real and imaginary parts of the complex parameters of the media and the functions of the distribution of the probability density or of the probability distribution, by means of which the corresponding calculations can be carried out. On the basis of experimentally studied spectra of the parameters of the electrical and mechanical properties in a sufficiently wide range of frequencies it is possible to determine the characteristics of the relaxation properties in a material: the effective times and the distribution of the relaxation times, and, thereby, it is possible to obtain information on the distinctive features of the progress of these processes and, consequently, also on the structure and composition of the studied materials. For expanding the experimental possibilities there are employed thermal-frequency studies of dynamic relaxation. There has been elaborated a theory and methodology of reduced variables which permits one, under certain conditions, to supplement mutually the frequency relationships by means of the thermal relationships and vice versa (Mikhailov et al., 1964). Furthermore, from the form of equations (8) - (9) it follows that the argument in these is the product $\omega\theta_{ef}$, i.e., if in relation to the temperature there occurs a change in the effective relaxation time θ_{ef} , then there is possibly a "parametric" dispersion of the electrical and mechanical properties of heterogeneous media, conditioned by a change in their composition or structure, which is especially promising in the studies of frozen earth materials (Frolov, 1976a).

Thus, the theory of dynamic relaxation processes permits one to carry out a complex analysis and interpretation of experimental data on the frequency-thermal dispersion of the parameters of the electrical and mechanical properties of frozen earth materials in order to expand and deepen our knowledge of the internal processes occurring within these materials.

STATE OF EXPERIMENTAL STUDIES OF DYNAMIC RELATIONS
IN FROZEN EARTH MATERIALS

Up to the present time some experimental data have been accumulated on the study of the frequency-temperature dispersion of the mechanical and electrical properties, which may be generalized, to a considerable degree, for polycrystalline ice (Bogorodskii, 1970; Bogorodskii et al., 1971; Pounder, 1967) and for frozen earth materials (Frolov, 1976a). In these and other studies there have been described the patterns of the frequency and temperature dependency of the parameters of the electrical properties of frozen sandy-clay earth materials and ice; there have been considered some mechanisms of the polarization capacity and electrical conductivity, and there have been obtained values for the activation energy, as well as data on the relaxation characteristics of frozen earth materials. In these studies there have also been presented the temperature dependencies of the moduli of elasticity of frozen earth materials of various composition and, in individual cases, of the parameters of the viscosity and energy absorption of elastic waves. The frequency relationships of the viscoelastic properties for frozen earth and saline ice have not yet been obtained. It is very important to establish the relationships between the different mechanical properties and also between the dynamic parameters of the electrical and the mechanical properties, since these provide the basis for the development of the corresponding physical methods for monitoring the state of frozen earth materials. In Figure 2 there are presented some examples of such interrelationships. It should be noted that the combined interpretation of the data on mechanical and electrical relaxation has allowed us (Frolov, 1976a) to show that the effective times of electrical and mechanical dynamic relaxation of frozen earth materials are approximately the same and consistent in their changes with temperature. In Figure 3 there are presented the coefficients of dynamic viscosity, η , and decay of elastic waves, α , for ice and certain frozen earth materials, calculated on the basis of the values of the effective times of the electrical relaxation and the moduli of elasticity at certain temperatures. The values obtained by these means are in good agreement with discrete data from special measurements, that are available in the literature. These results corroborate the hypothesis concerning the common nature of the formation and change of the electrical and the mechanical properties of frozen earth materials.

Figure 2

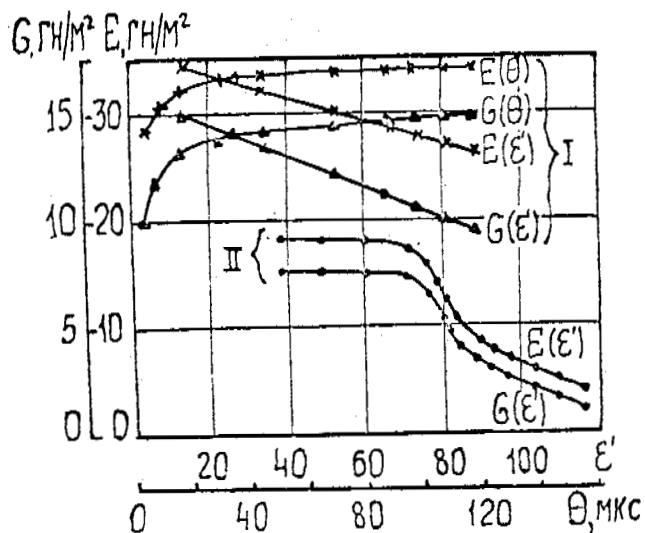

Interrelationship of the electrical characteristics ϵ and θ and the moduli of elasticity E and G .
I - sand; II - kaolin

Figure 3

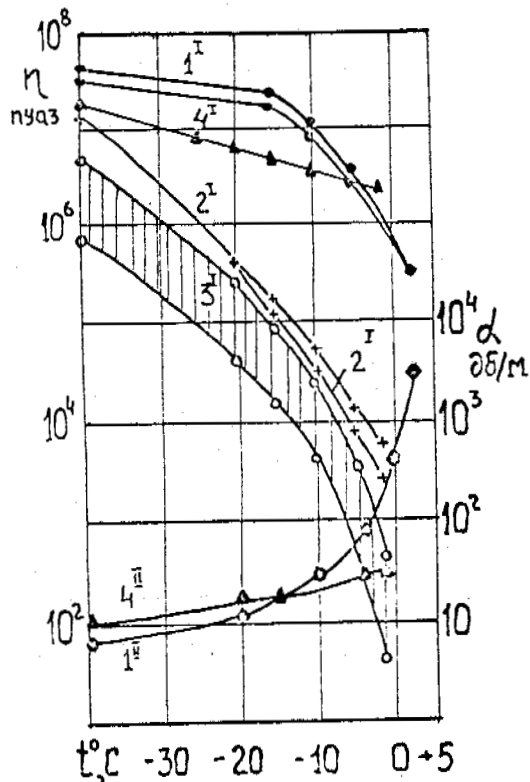

Temperature dependency of the coefficients of the dynamic effective viscosity (I) and the decay of elastic waves (II) of frozen earth materials.
1 - sand ($q = 0.5 - 1.0$); 2 - kaolin ($W = 25 - 125\%$);
3 - suglinok ($q = 0.35 - 0.92$); 4 - ice.

The study of the interrelationships of the mechanical properties has allowed us to predict some distinctive features of the thermal relationship of the tensile strength of frozen earth materials, which should have its maximal value at a particular content of the liquid phase (Frolov, 1976a).

In Figure 4 there is shown the interrelationship of Young's modulus and the tensile strength of some frozen earth materials (based on the results of studies by several authors), which illustrates the possible experimental character of a change in the latter.

Figure 4

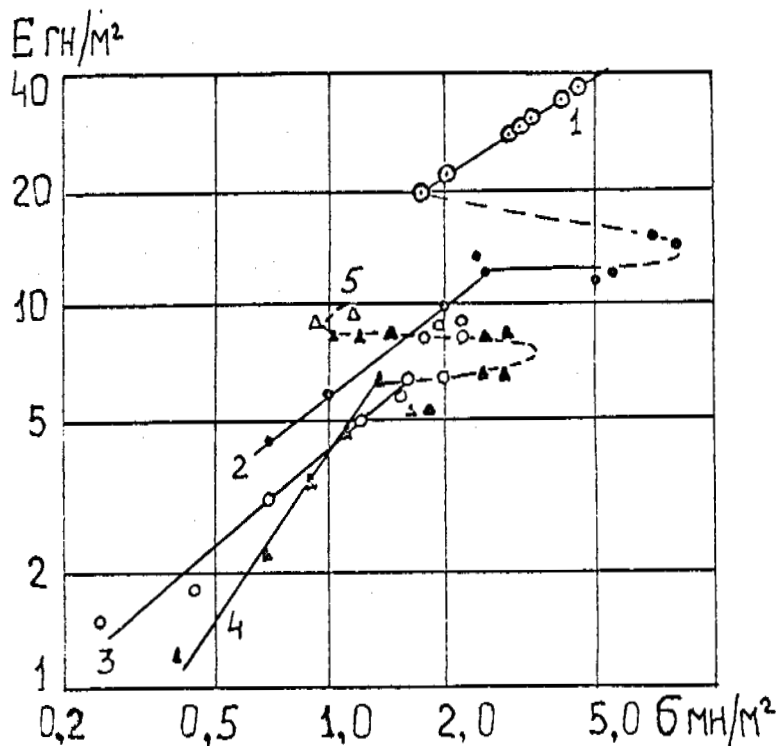

Interrelationship of Young's modulus and the limit of the tensile strength of frozen earth materials:
1 - sand; 2 - suglinok; 3 - saline ice;
4 - sea ice; 5 - fresh-water ice.

The presence of extreme values of the temperature dependency of the tensile strength for frozen sandy clay soils has been corroborated experimentally (E.P. Shusherina, Moscow State University). On the basis of the established patterns, obtained during the course of studies of dynamic

relaxation processes in frozen earth materials, there have been worked out the physical principles of several new electrometric and acoustical methods for evaluating the phase composition and the kinetics of its change in frozen earth materials, and also methods for evaluating their strength properties. During the course of these studies there have been revealed many characteristic features of the distribution of elastic and electromagnetic waves, which are of importance from the practical aspect. Finally, closely related to the studies of dynamic relaxation are the studies of various kinds of mechano-electrical phenomena and, especially, of the contact, seismoelectrical and piezoelectrical effects in frozen earth materials. These studies are only just starting but the initial data indicate that they have interesting prospects in geocryology, since they provide a source of information on the processes of the energy transformation in frozen earth materials and, consequently, they allow us to obtain information on the composition, structure and mechanisms of transformation occurring in these frozen earth materials.

CONCLUSION

Thus, at the present time there has taken shape a promising specialization in the physics of frozen earth materials, and dynamic spectroscopy in various force fields, which permits us to obtain unique information on the mechanisms of the internal processes, composition, structure and properties of frozen soil and ice. The development of study methods, based on the application of the described phenomena and the consideration of the obtained patterns of formation and change of properties, allow us to increase the efficiency of engineering-geocryological surveys right up to the creation of automated remote systems for monitoring changes in the state of frozen earth materials in detailed studies of cryological phenomena for the planning, construction and exploitation of various works, for carrying out technical procedures for land reclamation, for resolving problems of environmental protection, etc.

Studies of the processes of dynamic relaxation permit us to evaluate the parameters determining the conditions and patterns of distribution of waves in frozen earth materials and also have definite

prospects in the elaboration of methods for a directed action aimed at shaping predetermined properties. However, there often arise practical questions associated with the evaluation of slow changes in frozen earth materials when these are supporting foundations or elements of various kinds of structures, aerodromes, roads, pipelines, etc. For the resolution of questions of this type of knowledge of the dynamic parameters, determining the corresponding physical properties (elasticity, polarization capacity, electrical conductivity, viscosity, etc.), is necessary though not always sufficient, since often we do not know the mechanisms, interrelationship of sequence of many of the transformations in frozen soil and ice. There is no doubt, therefore, that it is important to continue and further perfect the studies on static relaxation in frozen earth materials (under laboratory and natural conditions) in order to obtain the parameters which integrally reflect the many slow relaxation processes of cryogenic transformations. A new level of such studies would be the combination of these with the described methods of relaxation spectroscopy, since this would allow us to substantially increase the level of the extraction of useful information in the carrying out of prolonged and laborious experiments in the study of various frozen earth materials in a wide range of negative temperatures. It is especially important to accomplish such a combination in the case of detailed investigations of the cryogenic transformations in the range from 0°C to the temperatures of the discontinuation of intensive phase transitions in frozen earth materials of a particular composition, and also of the transformations occurring with the action of stationary fields of mechanical stress on the frozen earth materials. The elaboration of complex apparatus is needed to provide for such investigations.

The further development of methods of dynamic and static relaxation spectroscopy is one of the most important ways for expanding our knowledge of these complicated subjects, which would allow us to obtain the information needed to proceed with the solution of many practical problems.

REFERENCES

- BARTENEV G.M. and ZELENEN Yu.V. (ed.) Relaksatsionnye yavleniya v polimerakh. (Relaxation phenomena in polymers). Leningrad, Publ. "Khimiya", 520 pages, 1972.
- BOGORODSKII V.V. (Ed.) Trudy AANII, T. 295 (Physics of ice. - Transactions of the Arctic and Antarctic Scientific Research Institute, Vol. 295) Leningrad, Publ. "Gidrometeoizdat", 180 pages, 1970.
- BOGORODSKII V.V., GUSEV A.V. and KHOKHLOV G.P. Fizika presnovodnogo l'da. (Physics of fresh-water ice). Leningrad, Publ. "Gidrometeoizdat", 226 pages, 1971.
- VOTYAKOV I.N. Fiziko-mekhanicheskie svoistva merzlykh i ottaivayushchikh gruntov Yakutii. (Physico-mechanical properties of frozen and thawing soils of Yakutia). Novosibirsk, Publ. "Nauka", 210 pages, 1975.
- VYALOV S.S. Reologicheskie svoistva i nesushchaya sposobnost' merzlykh gruntov. (Rheological properties and load-carrying capacity of frozen soils). Moscow, Izd-vo AN SSSR (Publ. Academy of Sciences of the U.S.S.R.) 257 pages, 1959.
- VYALOV S.S. Dlitel'noe razrushenie merzlogo grunta kak termoaktivatsionnyi protsess. (Long-term rupture of frozen soil as a thermally activated process). II Mezhdunarodnaya konferentsiya po merzloto-vedeniyu. Doklady i soobshcheniya, vyp. 4 (Second International Conference on Permafrost. Papers and reports, part 4). Yakutsk, pp. 16-25, 1973.
- DOSTOVALOV B.N. and KUDRYAVTSEV V.A. Obshchee merzlotovedenie. (General permafrost studies). Izd-vo MGU (Publ. Moscow State University) 403 pages, 1967.
- KUDRYAVTSEV V.A. (Ed.) Osnovy merzlotnogo prognoza pri inzhenerno-geologicheskikh issledovaniyakh. (Principles of permafrost forecasting in engineering-geological studies). Izd-vo MGU, 431 pages, 1974.
- MEL'NIKOV P.I., TOLSTIKHIN N.I. and NEKRASOV I.A. et al. Obshchee merzlotovedenie. (General permafrost studies). Novosibirsk, Publ. "Nauka", 291 pages, 1974.
- MIKHAILOV I.G., SOLOV'EV V.A. and SYRNIKOV Yu.P. Osnovy molekulyarnoi akustiki. (Principles of molecular acoustics). Moscow, Publ. "Nauka", 514 pages, 1964.
- PAUNDER E. (POUNDER E.R.). Fizika l'da. (The physics of ice). Moscow, Publ. "Mir", 189 pages, 1967.
- POSTNIKOV V.S. (Ed.) Mekhanizm relaksatsionnykh yavlenii v tverdykh telakh. (The mechanism of relaxation phenomena in solid bodies). Kaunas, 270 pages, 1974.

- REBINDER P.A. Fiziko-khimicheskaya mekhanika dispersnykh struktur. (Physico-chemical mechanics of fine-grained structures). In the book: Fiziko-khimicheskaya mekhanika pochv, gruntov, glin i stroimaterialov. (The physico-chemical mechanics of soils, sub-soils, clays and construction materials). Tashkent, pp. 3-27, 1966.
- REBINDER P.A. and SHCHUKIN E.D. Poverkhnostnye yavleniya v tverdykh telakh v protsesse ikh deformatsii i razrusheniya. (Surface phenomena in solid bodies during the process of their deformation and rupture). - Uspekhi fizicheskikh nauk (Progress of Physical Sciences), Vol. 108, pp. 3-42, 1972.
- SAVEL'EV B.A. Fizika, khimiya i stroenie prirodnykh l'dov i merzlykh gornyykh porod. (The physics, chemistry and structure of natural ice and frozen earth materials). Izd-vo MGU (Publ. Moscow State University), 506 pages, 1971.
- FROLOV A.D. Elektricheskie i uprugie svoistva kriogennykh porod (Electrical and elastic properties of frozen earth materials). Moscow, Publ. "Nedra", 254 pages, 1976a.
- FROLOV A.D. O predstavitel'nosti dinamicheskikh s staticheskikh modulei uprugosti merzlykh porod. (The representative nature of the dynamic and static moduli of elasticity of frozen earth materials). - "Izvestiya Vysshikh Uchebnykh Zavedenii. Geologiya i razvedka" ("Proceedings of Higher Educational Institutions. Geology and Prospecting"), No. 6, pp. 117-121, 1976b.
- TSYTOVICH N.A. Mekhanika merzlykh gruntov. (Mechanics of frozen soils). Moscow, Publ. "Vysshaya shkola", 445 pages, 1973.

ON THE ROLE OF THE COMPONENTS OF FROZEN CLAY SOILS IN
THE DEVELOPMENT OF STRENGTH AT DIFFERENT TEMPERATURES

R.V. Maksimyak, E.P. Shusherina, V.V. Rogov and M.I. Zabolotskaya
Research Institute of Foundations and Underground Structures,
Moscow State University, U.S.S.R.

It is well known that the strength of the ground is determined by the strength of its individual components and by the strength of the bonds between the structural elements. In non-uniform ground, including frozen soils, the strength is also governed in large measure by the number and size of the individual components, the proportional relation between them and their relative positioning, i.e., by the textural and structural characteristics of the system.

The rupture strength of frozen soils will vary according to the specific conditions obtaining (the duration of loading, the temperature, etc.). The effect of the temperature θ on the strength characteristics of frozen soils has been studied for the most part within a relatively narrow range of temperatures (to -20°C).

The fact that the use of frozen soils in engineering practice extends over a wider range of negative temperatures has resulted in research being done on the mechanical properties of these soils to temperatures of -60°C and below (Shusherina, 1968; Zikov, 1969; Shusherina et al, 1974 and others). This has made it possible to identify a number of new and interesting mechanisms.

Until recently it was assumed that in the vast majority of cases frozen clay soils have an appreciably lower strength (in particular, the compressive strength) than does young ice. Indeed, within the temperature

range that has been most studied (to -20°C), this dependence was noted by the majority of the authors (Pekarskaya, 1961; Tsytovich, 1957, 1973 and others). Latterly a number of studies have been published which attest to the fact that this principle does not at all times hold true (Zykov, 1969; Pekarskaya and Shloido, 1970; Shusherina, 1974; Shusherina et al, 1968, 1976 and others).

Data obtained by the Department of Permafrost Studies at Moscow State University with respect to the temperature dependence of the short-term compressive strength of frozen soils indicate that the nature of the increase in strength which occurs in various soils with a lowering of θ has its own characteristics and under certain conditions frozen clay soils can become stronger than ice. For example, (Figure 1), to $\theta = -35^{\circ}\text{C}$, clay (Kiev) is much weaker than ice and sand. In comparison with ice and sand, clay exhibits a higher rate of increase in its strength with cooling and this relationship holds true even below -35°C . The inflection which is observed in all of the $\sigma - \theta$ curves indicates that with a decrease in θ the rate of increase in the strength is initially attenuating and subsequently accelerating. This tendency is most pronounced in the case of the clays. Accordingly, clay becomes stronger than ice (below -35°C) and sand (below -50°C).

Figure 1

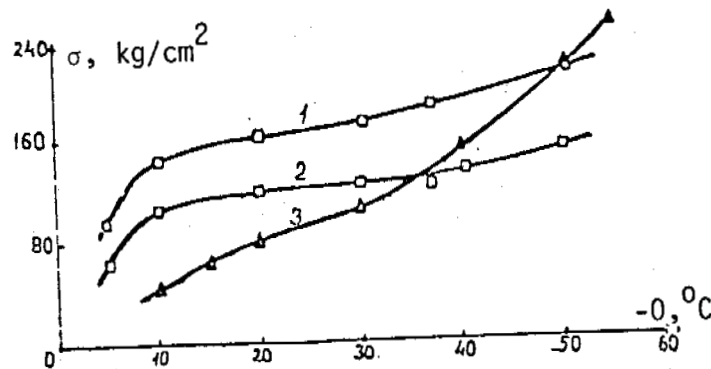

Dependence of the strength of frozen soils and ice on compression due to the temperature.
1 - sand, 2 - ice, 3 - clay (Shusherina et al. 1974)

The mechanism of change in the strength of frozen soils as the temperature decreases is evidently due to the physical-chemical processes that take place in frozen soils with a variation in the temperature.

The present study is of the role of the individual components of a frozen clay soil and also of their bonds in the development and change in its strength in relation to the temperature. For this purpose, data on the microstructure are used. The paper pertains only to the effect of the temperature θ on the rupture strength of already frozen soil, that is, one and the same variety of soil is studied at different values of θ . Questions pertaining to changes in the strength occurring during transition from the unfrozen to the frozen state are not touched upon. A dominant role in the development of the strength of unfrozen soils is played by the bonds between the particles which, as is well known, are several orders weaker than the skeletal particles and rupture occurs as a rule along the contacts of the microaggregates or other structural elements of the soil. In frozen soil, besides the structural elements and bonds that are typical of the unfrozen state, structural-textural characteristics exist which are caused by the water crystallization processes. In particular, a new component, namely ice, develops and it is this that in large measure determines the strength of a frozen soil (Pekarskaya, 1961; Tsytoich, 1973). The role of ice inclusions in the development of a soil's resistance to loading has not been conclusively established. There are, however, data (Veselov, 1963; Shusherina and Bobkov, 1968; Savel'ev, 1971 and others) indicative of an ambiguous dependence of the strength of frozen soils on ice content and temperature.

The emergence of ice crystals during freezing of a soil increases the number of additional contacts, and this leads to its strengthening. Moreover, a number of processes take place that lead to the formation not only of new structural elements but also of new cryogenic structural bonds (intra- and interaggregate bonds between the ice and the skeletal particles, inter- and intracrystalline bonds in the case of ice inclusions, etc.) which are essentially different from bonds in the unfrozen state.

In order to evaluate the role of the individual components and the bonds between them in the development of the strength of a frozen soil at

various negative temperatures it is necessary to ascertain the specific character of the variation in relation to the temperature, structure and texture of this soil, and the strengths of the individual components (in particular the ice) and the bonds between them.

We will consider the structural and textural characteristics of frozen clay soils at different temperatures on the basis of electron microscope investigations of clays (kaolin) and fine-grained clay suglinoks, conducted in samples of frozen pastes of massive structure (at θ of about -40°C).

Existing data (Vyalov and Maksimyak, 1970; Maksimyak, 1970; Shusherina et al, 1975 and others) indicate that the microstructure of frozen clay soils changes significantly with the temperature, it being possible to discern a number of common features and mechanisms in the various soils. In all cases the main structural elements are the microaggregates of the skeletal particles and the ice cement, represented by inter- and intraaggregate inclusions, consisting of several crystals of differing orientation. The interaggregate inclusions, which are chiefly confined to the interaggregate pores and cracks and contain the greater part of the ice, are characterized by differing dimensions. The largest of them (10 - 15 microns) are commensurate with the dimensions of the microaggregates. At elevated temperatures, films of unfrozen water are also recorded. In all cases, comparison of the clay particles with the ice inclusions attests to the larger size of the latter.

The dependence of the microstructure and microtexture of frozen soils on the temperature shows up in the specific character of the microaggregates and ice inclusions and in the development of a film of unfrozen water and cracks (Figures 2, 3, 4, 5).

The microaggregates of the skeleton are formed by clay - and fine-grained particles tightly adjoining one another as a result of the formation of strong intraaggregate bonds. The dimensions of the microaggregates vary with the temperature: in the -0.5 to -5°C range they are 2 to 10 microns, at temperatures of -15 to -20°C they increase to 100 microns, thereafter (below -20°C) they again decrease to 10 to 20 microns.

Figure 2



Microstructure of frozen kaolin at a temperature of -3°C .

Figure 3

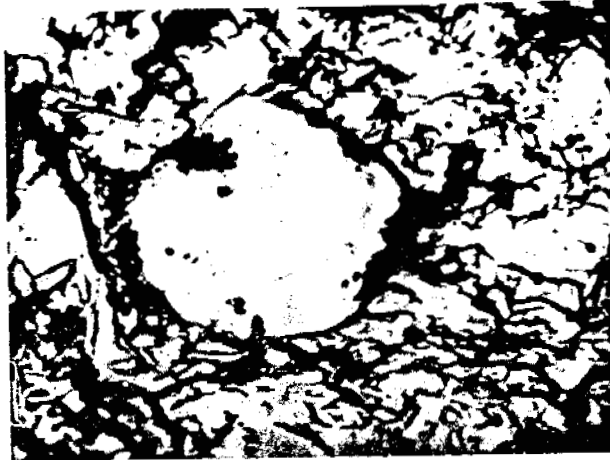

Microstructure of frozen kaolin at a temperature of -10°C .

Figure 4



Microstructure of frozen kaolin at a temperature of -35°C .

Figure 5



Microcracks in ice inclusions.

The shape and dimensions of the ice inclusions and also the number of crystals in them, vary with the temperature. At $\theta = -0.5$ to -5°C the ice inclusions consist of several indistinctly defined crystals of fairly large dimensions (10 to 100 microns). With a decrease in θ to -10°C the ice inclusions assume sharper outlines and become somewhat smaller. On the surface of some of the inclusions curved cracks appear as a rule issuing from separate points. Cracks are not recorded in the -15 to -25°C temperature range. With a further lowering of the temperature to -30 to -35°C the ice inclusions consist of crystals ranging from one to several microns in size. Cracks are again seen on their surface but in this case they are straight or slightly curved and are confined to the boundaries of the microaggregates (Figure 5). At lower temperatures the cracks become narrower and fewer in number.

Unfrozen water was observed only in the -0.5 to -10°C temperature range in the form of films surrounding the fine-grained and clay particles. The thickness of the films decreased as the temperature became lower.

The typical structural and textural characteristics of frozen clay soils at different values of θ which were ascertained from the electron microscope investigations must determine in large measure the variation in the strength properties of these soils with the temperature.

In order to estimate the role of the individual components in the development of the mechanical properties of a frozen clay soil, we will consider the variation in its structural elements and in the bonds between them. As already noted, as compared with the frozen soil as a whole, the skeletal particles are much (several orders) stronger. Therefore, the dependence of the strength of these particles on the temperature can be ignored.

The results of numerous mechanical tests (compression, shearing and rupture) of rapidly disintegrating fine crystal ice indicate that during cooling in the temperature range above -10°C (involving the 0° to -5° to -7°C interval of rapid phase transitions of the water in frozen clay soils), an appreciable strengthening of the ice occurs. With a further decrease in θ the increase in its strength is insignificant (see Figure 1). It must also be pointed out that data exist which indicate a decrease in the strength of the ice when θ drops below -20°C (Zykov, 1969; Shusherina et al, 1976).

The tests using fine crystal ice do not fully reproduce the characteristics of ground ice. It can be assumed, however, that the principal mechanisms of temperature dependant changes in the strength of both types of ice are similar.

Accordingly, the role of the mechanical properties of ice in the strengthening of frozen clay soils in the course of their cooling is only appreciable in the temperature range higher than -10°C . At lower θ the ice is no longer a determining factor.

We will consider the effect of the temperature on the strength of the structural bonds extending across a film of unfrozen water. According to a paper by Pekarskaya (1961) which discusses questions relating to the strength of frozen soils in the temperature range higher than -10° to -20°C , the important role played by unfrozen water in the development of the mechanical properties of these soils is limited to the zone of rapid phase transitions (after N.A. Tsykovich, 1973) higher than -5° to -7°C .

As the data of Shusherina et al, (1974) indicate, a lowering of the θ of frozen clay from -22° to -35°C causes a decrease in the quantity of

unfrozen water (W_u) amounting to 1.3% in all, while the strength of the soil in this θ range increases from 80 to 160 kg/cm^2 . With a lowering of θ from -7° to -11°C the value of W_u decreases by 2%, while the strength changes from 30 to 48 kg/cm^2 . The most rapid increase in strength begins at a θ of approximately -30°C , when the quantity of unfrozen water approximates to 4% for the soil in question.

Studies with this clay in the unfrozen state have shown that when the moisture content of the soil gradually decreases due to drying out the strength increases at differing rates. When the moisture content of unfrozen clay reaches values corresponding to the quantity of unfrozen water of this soil at $\theta = -35^\circ\text{C}$ (about 5%), a pronounced increase in the strength is initiated (Figure 6).

Figure 6

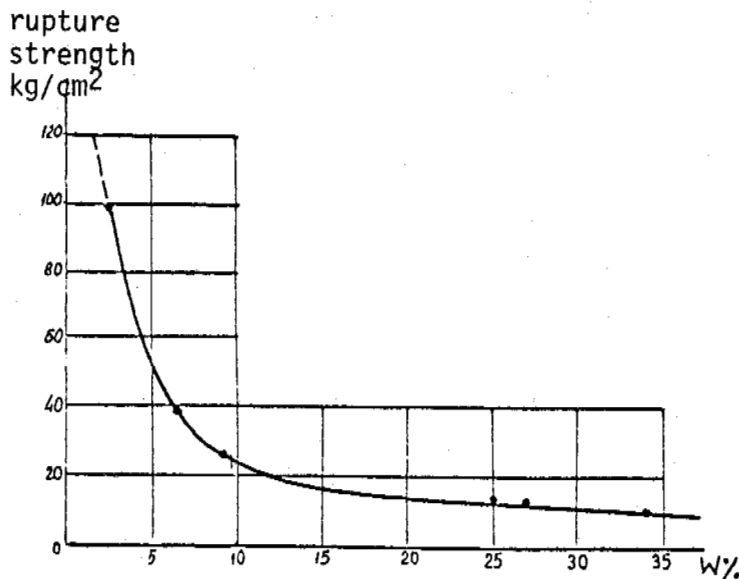

Dependence of the strength of a clay soil on the moisture content.

A one percent change in the moisture content in this interval causes a twofold increase in the strength of the soil, that is, the picture is the same as that observed with a lowering of the temperature below -35°C . The typical moisture content below which the strength increases appreciably is probably close to the moisture content at which the effect of molecular forces of short-range order begins to be felt. Freezing or evaporation of the film of water leads to intensive binding of the particles and to a marked

increase in the bonds between them. An important role in this is evidently also played by the increase in the ion concentration of the pore solution, the precipitation of salts and the formation of crystallization bonds. It is interesting to note that at a temperature of -30°C the strengths σ of frozen clay and ice equal 108 and 126 kg/cm^2 respectively (Shusherina et al, 1974), while for the same clay in the unfrozen state and with a moisture content corresponding to the quantity of unfrozen water at $\theta = -30^{\circ}\text{C}$, $\sigma = 100 \text{ kg}/\text{cm}^2$. This may indicate that the strength of the frozen soil at this temperature is mainly determined by the bonds between the structural elements of the skeleton. Although the ice also fulfills a strengthening role, the importance of its strength characteristics is fully commensurate with the strength of the interaggregate structural bonds. With a further lowering of θ the strength of the structural bonds begins to exceed the rupture strength of the ice inclusions. Thus, the data (Shusherina et al, 1974) indicate that at $\theta = -40^{\circ}\text{C}$, in frozen clay $\sigma = 160 \text{ kg}/\text{cm}^2$ and in ice $\sigma = 138 \text{ kg}/\text{cm}^2$, i.e., the bonds between the individual structural elements are important in the development of the strength characteristics of frozen soil at this temperature.

Also attesting to the role of the bonds and the individual components of the frozen soil are the electron microscope studies of the rupture during compression of frozen kaolin at the temperature values being investigated.

The microstructural analysis of the rupture surface at various temperatures showed that at a temperature of -3°C the fracturing of the specimen occurred mainly along the films of unfrozen water. A cleavage plane with poorly defined boundaries lies between the structural elements of the relief. Sometimes there is crumpling and displacement of the film in the direction of shearing. The rupture zone extended mainly along the contacts between the microblocks and microaggregates of clay particles, and sometimes along the contact between the soil aggregate and the ice. Almost no crack formation was noted in the ice. Sometimes, individual soil particles can be seen in the ice crystals (Savel'ev, 1971). This indicates that the strength of the bonds between the soil particles and the ice crystals exceeds that of the bonds between the soil aggregates, which is also confirmed by the data in Figure 7.

Figure 7

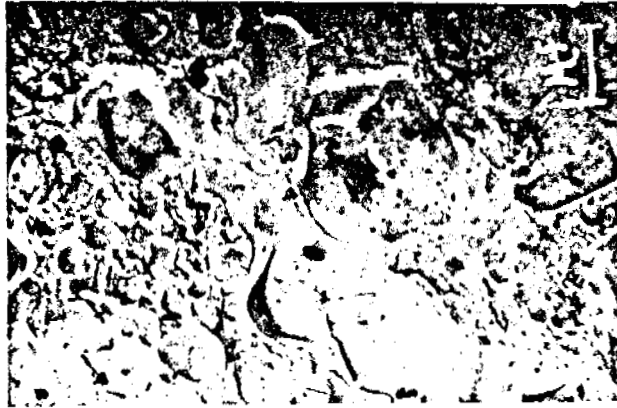

Rupture surface of frozen kaolin at a temperature of -3°C .

At a temperature of -10°C the rupture surface is very distinct, with well defined relief elements. Breakage occurs mainly along the contacts of the microaggregates of the soil (Figure 8). Also to be seen is the formation of cracks, developing both along the contact between the clay particles in areas where ice formations are absent, and cutting across individual ice inclusions. In cases where the rupture zone extends into regions containing ice inclusions, rupturing occurs along the contact between the particles, as indicated by the presence of mineral particles on the surface of the ice grains.

Figure 8

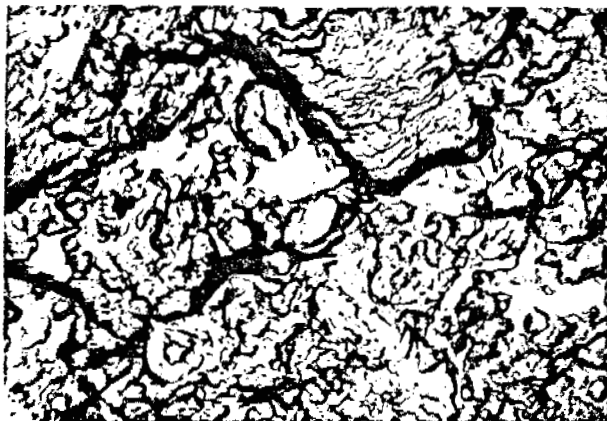

Rupture surface of frozen kaolin at a temperature of -10°C .

At a temperature of -35°C a typical feature of the rupture surface is its localization within zones containing ice inclusions and especially within zones containing minute streaks of polycrystalline ice formations. That is to say, it is primarily in the ice inclusions, being the weakest point in the system, that soil rupture begins. The formation of microcracks is noted in certain of what are evidently more stressed ice crystals. At this temperature the rupture zone is characterised by a conchoidal fracture of the ice crystals (Figure 9).

Figure 9

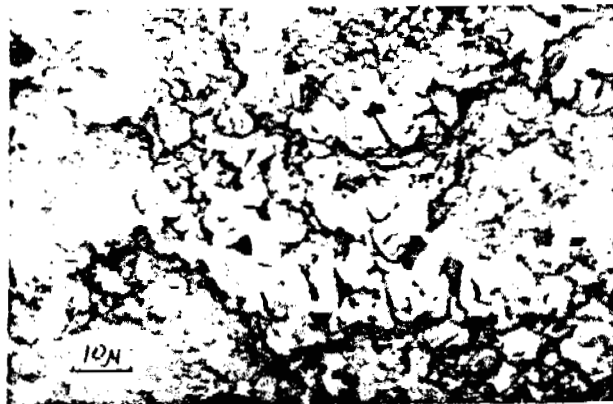

Rupture surface of frozen kaolin at a temperature of -35°C .

Both the ice inclusions and the microaggregates contribute to the development of the rupture zone. Fracturing also occurs along their boundaries. In this case the interaggregate bonds are evidently the strengthening factor, since with substantial ice formation rupture occurs along the ice inclusions. As the moisture content (iciness) of the frozen soil increases its strength is seen to decrease (Veselov, 1963; Shusherina and Bobkov, 1968). That the ice is weaker than the contacts between the skeletal particles on the one hand and the contacts between the particles and the ice on the other, is indicated by the ice etching and the absence of soil particles on the surface of the ice crystals.

In summing up the results of the investigations, the characteristics of development of the strength of frozen clay soils at different temperatures can be described as follows. During transition of the

soil from the unfrozen to the frozen state an intensive increase in the strength occurs. This is due to the increase in the number of contacts in the soil with crystallisation of the ice and also because of the augmented strength of the intra- and interaggregate bonds as a result of the decrease in the thickness of the water film. The more intensive rise in the strength of the ice as compared to the frozen soil during lowering of θ from -3° to -10°C can be explained, on the one hand, by the growth of crystallisation bonds and the strengthening of the crystalline ice framework, and on the other, by the presence of a sufficiently thick film of water in the frozen soil, inhibiting the interaction between the skeletal particles. In this range of temperatures the decrease of several percent in the quantity of bound water does not cause the skeletal particles to cling together sufficiently for the action of molecular forces between them. But it does increase to some extent the strength of the bonds. This is also reflected in the gradual rise in the strength of the frozen soil. The determining factor here is the strength of the structural bonds extending across the film of unfrozen water, as indicated by the already described rupture data. The ice in this case emerges as the factor strengthening the soil. Beginning at a temperature of approximately -10°C , when the crystallisation of the ice and the development of microaggregates is for the most accomplished, the film of unfrozen water becomes much thinner, substantially increasing the strength of the bonds between the particles. This is reflected in the increased intensity of the strenghtening of the frozen soil as the temperature decreases. Here, the strengthening of the ice is relatively slight. Participating in the rupture process are the contacts between the aggregates of the skeletal particles and also the most stressed ice crystals and the intercrystalline bonds of the ice.

Evidently it can be assumed that in the temperature range from -10° to -30°C the strength of the individual crystals and intercrystalline bonds of the ice is commensurate with the strength of the bonds between the soil particles. The bond between the ice crystals and the skeletal particles proves to be the strongest link. With a further lowering of the temperature the slight change in the thickness of the film of unfrozen water leads to a marked rise in the strength of the intra- and interaggregate bonds of the skeletal particles, whereas the intensity of the rise in the strength of the

ice is relatively slight. As a result, the ice inclusions prove to be the weakest point in the structural framework of the frozen clay soil, and the strength of the frozen clay begins to surpass that of the ice. The contacts between the soil particles emerge as the strengthening factor, as indicated by the data on the decrease in the strength of clay soils as the iciness increases (Veselov, 1963; Shusherina and Bobkov, 1968).

Thus, we can conclude that the role of the individual components of frozen soils in the development of their strength is not always single-valued and may change depending on the conditions. Thus, a change in the temperature may lead to the ice being transformed from a strengthening to a weakening factor, whereas the disengaging particles of the film of unfrozen water become the strengthening factor as the temperature falls.

In analysing the role of the components of the frozen soil, it is also necessary to allow for the operating condition of the frozen soil. In this paper we have discussed the effect of individual factors on the arbitrarily instantaneous strength of soils during compression. As the studies indicate (Pekarskaya and Shloido, 1970; Shusherina, 1974; Shusherina and Vryachev et al, 1974) the role of the components of a frozen soil in its resistance to rupture and compression can be highly variable. The role of the different components in the development of long-term strength will also vary, depending on the temperature, the duration of the loading, etc. (Vyalov and Maksimyak, 1970; Shusherian et al, 1975 and others).

The foregoing information makes it possible to assess the complexity and ambiguity of the processes occurring in frozen soils under different conditions and in particular, when there is a change in the temperature. There is currently a vast body of data both agreeing with and contradicting one another. The questions examined in this paper are in many ways problematical and are not put forward as a final solution to the problem. The large quantity of findings and investigations relating to the strength and deformability of frozen soils depending on various factors, including microstructure, are indicative of the immense interest in these questions, which require further elaboration and solution.

REFERENCES

- VESELOV, G.M. On the change in the strength of the properties of frozen soils in relation to the moisture content. In: The Physical and Mechanical Properties, Pressure and Rupture of Soils. Moscow Izd-VO AN SSSR, pp. 127-131, 1963.
- VYALOV, S.S. and MAKSIMYAK, R.V. The change in the structure of frozen clay soils during deformation under creep conditions. Authors' abstracts, All-Union Conference on Permafrost: Izd-vo Moscow State University, pp. 138-139, 1970.
- ZYKOV, Yu.D. A study of the dependence of the elastic properties of kaolin on temperature and moisture content by ultrasonic methods. In: Permafrost Research (Merzlotnye issledovaniya), No. 9, Izd-vo Moscow State University, pp. 183-184, 1969.
- MAKSIMYAK, R.V. A study of the microstructure of frozen kaolin and the effect on it of actual stress. In: Foundations, Footings and Underground Installations. Moscow, pp. 387-392, 1970.
- PEKARSKAYA, N.K. On the strength of frozen soils. "Results of laboratory investigations of frozen soils". Collection No. 4, Moscow, Izd-vo AN SSSR, pp. 241-251, 1961.
- PEKARSKAYA, N.K. and SHLOIDO, G.A. Determining the strength of the properties of frozen soils under conditions of rapid deformations - Authors' abstracts, All-Union Conference on Permafrost. Izd-vo Moscow State University, pp. 180-182, 1970.
- SAVEL'EV, I.B. Modifying effect of a frozen fine-grained foundation on the structure of the near-contact layer of ice. - Doklady AN SSSR, Vol. 201, No. 1, pp. 86-89, 1974.
- TYUTYUNOV, I.A. The physical and chemical basis of the development of the strength of frozen soils. In: Physical and Chemical Processes in Freezing Soils and Methods of Controlling Them. Moscow, Stroiizdat, pp. 3-22, 1974.
- TSYTOVICH, N.A. Physical and physical-mechanical processes in freezing and frozen soils. In: Results of Laboratory Investigations of Frozen Soils. No. 3, Moscow, Izd-vo AN SSSR, pp. 31-32, 1957.
- TSYTOVICH, N.A. The Mechanics of Frozen Soils. Moscow, "Vysshaya Shkola", 445 pages, 1973.
- SHUSHERINA, E.P. The rupture strength of fine-ground frozen soils in the low temperature range (to -60°C). In: Permafrost Research, No. 14, Izd-vo Moscow State University, pp. 179-190, 1974.

- SHUSHERINA, E.P. and BOBKOV, Yu.P. The temperature dependence of the strength of frozen soils and ice. Proceedings of the All-Union Conference on the Exchange of Experience in Construction Work under Harsh Climatic Conditions. Tyumen, pp. 94-106, 1968.
- SHUSHERINA, E.P., VRACHEV, V.V. and IVASHCHENKO, I.N. New data on the mechanical properties of frozen soils at low temperatures (to -55°C). In: Permafrost Research, No. 14, Izd-vo Moscow State University, pp. 190-196, 1974.
- SHUSHERINA, E.P., ROGOV, V.V. and ZABOLOTSKAYA, M.I. Microstructure of frozen clay soils during their cooling from -5° to -50°C (from the data of electron microscopy). "Vestnik Moscow State University, geol. series", No. 6, pp. 106-108, 1975.
- SHUSHERINA, E.P., ZAITSEV, V.I., ROGOV, V.V. and ABRAMKINA, S.B. The rupture strength of fine-grained permafrost soils and wedge ice. In: Permafrost Research, No. 16. Izd-vo Moscow State University, pp. 219-230, 1976.

KINETIC THEORY OF DEFORMATION OF FROZEN SOILS

S.S. Vyalov

Research Institute of Foundations and Underground Structures
Moscow, U.S.S.R.

Deformation is a thermodynamic process by virtue of its relation to the energy exchange between a given body and the surrounding medium. This should be allowed for, especially in the mechanics of frozen soils, since mechanical and thermal processes in these soils are closely interrelated. However, the course of development of engineering geocryology was such that the aforementioned processes and the equations describing them were treated separately. It is evident, that it would be more correct to describe thermal and mechanical processes by a single system of equations which would include both the external forces which vary with time and the temperature. The thermodynamic equations make this possible. At the same time, these equations are, in a general case, phenomenological equations, since they include laws derived from the study of macroprocesses. To ensure that the equations of state would reflect the physical nature of a process, it is essential to proceed from the study of microprocesses and apply methods of molecular physics.

Without claiming to have solved the problem as a whole, we shall show that deformation of frozen soils is well described with the help of the kinetic theory of deformation. According to this theory, the deformation and failure of soil can be regarded as a thermoactivated process caused by the displacement of soil particles as a result of energy of activation imparted to them.

The kinetic theory of long-term failure of frozen soils was discussed by us in a previous communication (Vyalov, 1973). The present

paper constitutes an attempt to define the general principles of the kinetic theory of deformation of frozen soils. We shall also derive the equation of state of these soils which relates the deformation rate to the external force, temperature and physical properties of the soil.

It is known from experiments that the nature of deformation of frozen soils may differ depending on the load and the temperature (Figure 1). In some cases deformation attenuates, in other cases it increases indefinitely but at a decreasing rate. Deformation may also develop at a constant rate similarly to a flow of viscous media. Finally, it may develop at an increasing rate terminating in failure. The existing empirical equations can describe only one of these processes. We shall show that on the basis of the kinetic theory it is possible to obtain a generalized equation describing all aforementioned types of deformation.

Figure 1

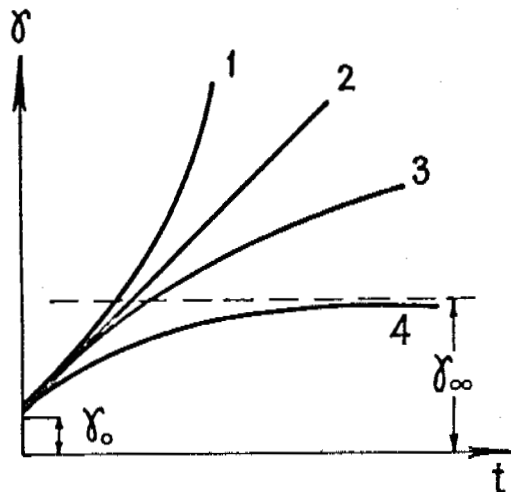

Creep of frozen soil.

- 1 - progressive flow at an increasing rate;
- 2 - stabilized flow at a constant rate;
- 3 - non-attenuating flow at a decreasing rate;
- 4 - attenuating creep.

In the light of the proposed kinetic theory we regard the soil as a random combination of microstructural elements, i.e. mineral particles, their aggregates and ice, surrounded by films of unfrozen water and bonded together by forces of interparticle interaction. The presence of these bonds

stabilizes the position of the microstructural elements and the equilibrium state of the elements corresponds to the minimum of the potential energy. It is as if the particles were divided by an energy barrier which keeps them in a state of equilibrium. In this position the particles are subjected to thermal oscillations at a frequency $1/t_0$. To move, the particle must overcome the energy barrier and enter a new state of equilibrium. For this, activation energy must be imparted to a particle, which is equal to or greater than the bond energy between the particles, i.e. equal to the height of the energy barrier. Considering the random arrangement of all structural elements and their small dimensions relative to any given volume of soil, we can use the statistical approach and apply to the soil the Boltzmann distribution law, assuming that the number of activated particles having the activation energy U is equal to $N = N_0 e^{-U/k\theta}$. Let us assume further that the average time t during which a structural element remains in the position of equilibrium is inversely proportional to the number of activated elements, i.e. it is equal to:

$$t = t_0 e^{U/k\theta}, \quad (1)$$

where $t_0 = h/k\theta$ is the period of thermal oscillations of elementary particles about the equilibrium position, sec; h is the Planck constant, joule/ K^0 ; k is the Boltzmann constant, joule/ K^0 ; and θ is the absolute temperature, K .

If the activation energy acts for a long time, the particle moves continuously from one equilibrium position to another, as if jumping over the energy barriers. The number of such "jumps" j in unit time is proportional to $1/t$; in turn j defines the deformation rate $d\gamma/dt = \dot{\gamma}$. According to the Newtonian law, the flow rate is equal to $\dot{\gamma} = r/\eta$ and therefore, according to Frenkel-Eyring, the viscosity coefficient η can be expressed as:

$$\eta = A e^{U/k\theta} \quad (2)$$

where $A = 6k\theta t_0/V$, V being the molar volume. This expression holds for an ideally viscous Newtonian fluid, whose flow rate is directly proportional to stress. For a nonlinear viscous medium, Eyring obtained the expression for variable viscosity:

$$\eta(r) = \frac{r}{\dot{\gamma}^* \text{Sh}(r/r^*)} \quad (2')$$

Figure 2

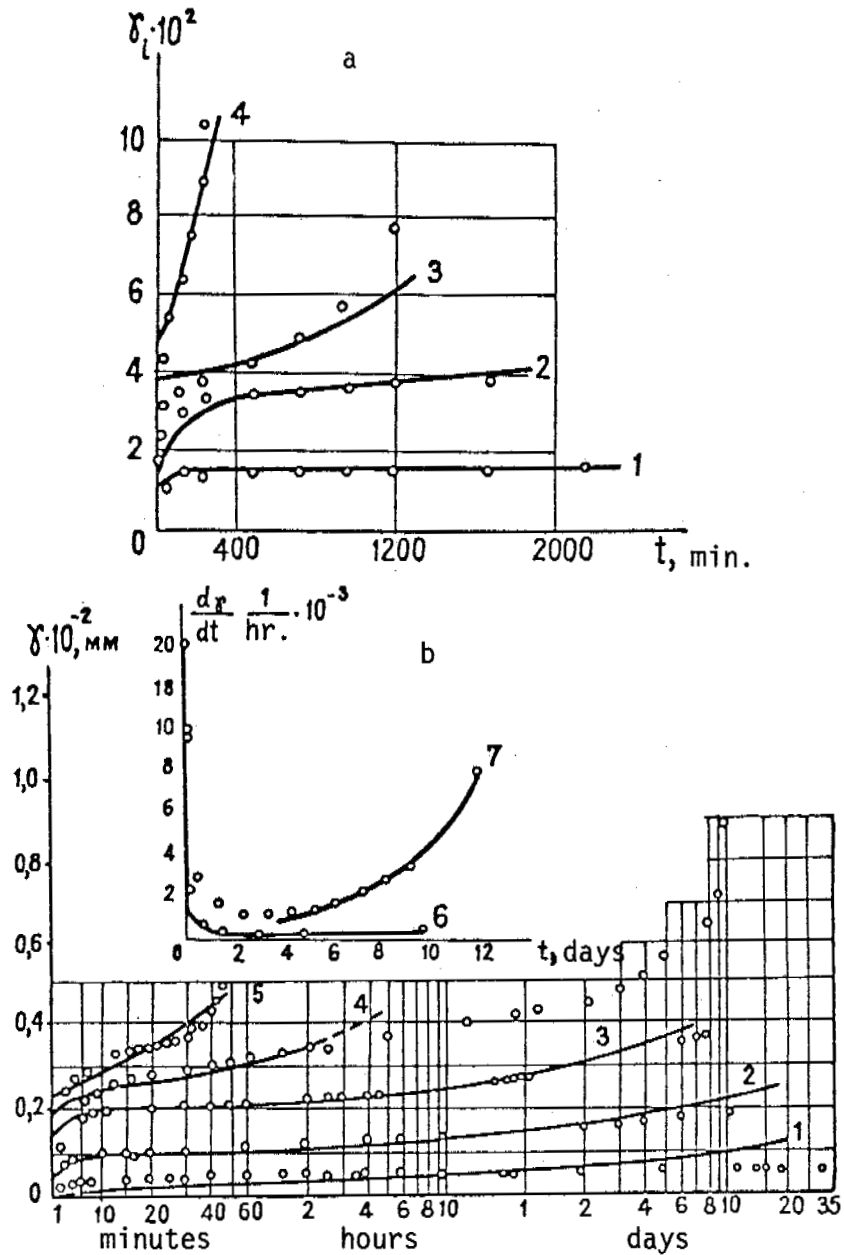

Comparison of experimental results with the data calculated from equation (12)

a - creep curves of frozen supes ($\theta = -5^{\circ}\text{C}$) subjected to uniaxial compression under the following loads r_i : 1 - 8.7; 2 - 13.1;

3 - 14.5; 4 - 17.4×10^5 Pa.

b - creep curves of unfrozen clay soil (kaolin, $W = 38\%$) subjected to shear under the following loads r : 1 - 83; 2 - 90; 3 - 100; 4 - 135;

5 - 165×10^2 Pa; and curves illustrating deformation rate vs time: r : 6 - 60×10^2 Pa; 7 - 180×10^2 Pa

This expression was used to describe creep of unfrozen soil (Mitchell a.o., 1968), ice (Dillon a.o., 1967) and frozen soil (Andersland a.o., 1967). However, both expressions (2) and (2') describe only stabilized flow at a constant rate (curve 2, Figure 2). This is due to the fact that the formulae were derived for an idealized medium whose properties do not change during deformation. In real soils, on the other hand, deformation is accompanied by a change in their microstructure and as a result of this the activation energy varies. Indeed, if at a certain moment of time t_1 the energy required to displace a particle is U_1 , then at a subsequent moment t_2 a different energy U_2 will be required because of changes in the microstructure of the soil, and hence in structural bonds, resulting from the preceding particle displacement. U_2 may be lower or higher than U_1 depending on the changes in structural bonds.

Hence, the activation energy of soil is a variable which depends on the applied stress r and its duration t , i.e. $U = U(r,t)$.

Generally speaking, in the kinetic theory processes are treated at a molecular or an atomic level and U refers to the bonds between molecules or atoms. Deformation of soil results not from a displacement of molecules in a fluid component and not from a displacement of atoms in mineral particles but from a displacement of particles themselves (or their aggregates) along films of unfrozen water. Therefore, when we apply the term "activation energy" to soils, we do so conditionally and imply that this term stands for the energy which must be imparted to a particle in order to disturb its bonds with neighbouring particles. Since the structure of frozen soil represents a combination of mineral particles (of vastly different sizes, shapes and arrangements), their aggregates and ice, it is best to refer activation energy to a certain unit microvolume of soil and treat the latter as a structural element.

Let us now examine the changes in the microstructure of frozen soil due to an external load.

Applied stresses bring about a rupture of bonds, displacement of particles and their reorientation and rearrangement at the weakest points of

the structure. The ice-cement melts in the places of stress concentration and replenishes the film water. It is then squeezed out together with this water and refreezes in places of low pressure having attained a state of equilibrium at given temperature and pressure. At the same time, stress application results in a viscous flow of ice inclusions. The displacement of particles is accompanied by the appearance of structural defects, i.e. microcracks, microvoids, etc. When the density of the defects W , i.e. the degree of damage in a unit area of the cross section, reaches a certain critical value $W = W_{\gamma}$, the soil fails.

The fact that there is crack formation, as well as melting, squeezing out and refreezing of ice in the soil was confirmed by us earlier in a series of penetration tests on frozen soils (Vyalov, 1959). Distinct cracks formed at the points of maximum tangential stresses (at an angle to the edge of the plate) could be seen in the cross sections of soil slabs subjected to penetration tests. The cracks were filled with ice which melted and was then squeezed out from under the plate. In a series of microstructural investigations, R.V. Maksimyak (1970) showed in exactly the same way that deformation of frozen soil under conditions of pure shear is accompanied by displacement and reorientation of particles, ice melting and formation of microcracks.

Disturbance of interparticle bonds, ice melting and development of defects lead to weakening of structural bonds. But simultaneously with this the bonds are also strengthened as a result of rearrangement and better compaction of particles, partial restoration of disturbed and formation of new bonds, and refreezing (regelation) of melted and squeezed out ice. If strengthening predominates over weakening, deformation attenuates. If strengthening and weakening are mutually compensated, there is a flow at constant rate (similar to viscous flow). However, if weakening is the predominant process, there will be a nonattenuating, progressive flow terminating in failure.

Based on this, we can express the activation energy at any moment of time as follows:

$$\bar{U} = \bar{U}_0 - \bar{U}_1 + \bar{U}_2, \quad (3)$$

where $\bar{U} = U/k\theta$ is the relative value of U , \bar{U}_0 is the initial (prior to deformation) activation energy, \bar{U}_1 and \bar{U}_2 are the relative activation energies required to weaken (\bar{U}_1) or strengthen (\bar{U}_2) the structure. The ratio of \bar{U}_1 to \bar{U}_2 determines the direction of the deformation process.

We can assume that

$$d\bar{U}_1 = \rho_1 \frac{dW}{1-W}; \quad d\bar{U}_2 = \rho_2 \frac{d\Omega}{1-\Omega}, \quad (4)$$

where W is the weakening index corresponding to the degree of structural damage due to defects, while Ω is the strengthening index.

The pattern of changes of these indices with time was shown for unfrozen soils by R.V. Maksimyak (Vyalov et al., 1970). Assuming similar patterns for frozen soils, we write:

$$\begin{aligned} 1 - W &= (1 - W_0)(t + 1)^{-k_1 \bar{r}}; \\ 1 - \Omega &= (1 - \Omega_0)(t + 1)^{-k_2}, \end{aligned} \quad (5)$$

where $\bar{r} = \frac{r}{r_0 - r}$ is the stress level, r_0 is the strength of soil under rapid loading (instantaneous strength), W_0 and Ω_0 are the initial ($t = 0$) indices W and Ω , and k_1 and k_2 are parameters.

Substituting these ratios into equation (4) and integrating the latter we obtain:

$$\bar{U}_1 = \lambda_1 \int_0^t \bar{r} \frac{dt}{t+1}; \quad \bar{U}_2 = \lambda_2 \int_0^t \frac{dt}{t+1}, \quad (6)$$

where $\lambda_1 = \rho_1 k_1$, $\lambda_2 = \rho_2 k_2$. It follows from this ($\bar{r} = \text{const}$) that:

$$\bar{U}_1 = \lambda_1 \bar{r} \ln(t + 1); \quad \bar{U}_2 = \lambda_2 \ln(t + 1). \quad (7)$$

Accordingly equation (3) will assume the following form:

$$\bar{U} = \bar{U}_0 + [\lambda_2 - \lambda_1 \bar{r}] \ln(t + 1). \quad (8)$$

This is the variable value of activation energy and must be included in formula (2). Then:

$$\begin{aligned} \dot{\gamma} &= \frac{r}{\eta(r_1 t)} = \frac{r}{A} \exp[-(\bar{U}_0 - \bar{U}_1 + \bar{U}_2)] = \\ &= \frac{r}{A} e^{-\bar{U}_0} e^{-[\lambda_2 - \lambda_1 r] \ln(t+1)} \end{aligned} \quad (9)$$

It follows that:

$$\dot{\gamma} = \frac{r}{\eta_0} (t+1)^{-n(r)} \approx \frac{r}{\eta_0} t^{-n(r)} \quad (10)$$

where t is the nondimensional time t/t^* (t^* is the unit time), while

$$n = \lambda_2 - \lambda_1 \frac{r}{r_0 - r}. \quad (11)$$

Formula (10) is the equation of the kinetic theory of deformation based on the aforementioned physical processes which occur in the microstructure of soil. The respective parameters of this equation have definite physical meanings: $\eta_0 = \frac{6k\theta t_0}{V} e^{U_0/k\theta}$ is the initial viscosity of soil (at $r = 0$, $t = 0$); $\lambda_1 = \frac{1}{\nu k\theta} \ln \frac{1-W_r}{1-W_0}$ is a structural parameter which describes the tendency of soil towards weakening of structural bonds and which depends on the ratio of the damaged area at the moment of failure $(1 - W_r) = \text{const}$ to the undamaged area in the initial state; $\lambda_2 = \frac{k_2(1-\Omega)}{k\theta} \frac{dU_2}{d\Omega}$ is a structural parameter which characterizes the tendency of soil towards strengthening of structural bonds.

Equations (10) and (11) refer to the case of pure shear. For a complex stressed state we have:

$$\dot{\gamma}_i = \frac{r_i}{\eta_0} (t+1)^{-n(r)}. \quad (12)$$

Here

$$\begin{aligned} n(r) &= \lambda_2 - \lambda_1 \frac{r_i}{r_0 - r_i}; \\ r_0 &= r_{s(0)} \left[1 + \frac{\sigma_m}{H_0} \right]^{\lambda_3} \end{aligned}$$

where $r_{s(0)}$ is the instantaneous strength (the yield limit) at pure shear, H_0 and λ_3 are the parameters of bonding (in many cases $\lambda_3 = 1$, so that $H_0 = r_{s(0)}/\text{tg}\psi$ where ψ is the angle of internal friction at an octahedral site;

$$\begin{aligned} r_i &= \sqrt{\frac{1}{6}} \sqrt{(\sigma_1 - \sigma_2)^2 + (\sigma_2 - \sigma_3)^2 + (\sigma_3 - \sigma_1)^2}; \\ \dot{\gamma}_i &= \frac{2}{\sqrt{6}} \sqrt{(\epsilon_1 - \epsilon_2)^2 + (\epsilon_2 - \epsilon_3)^2 + (\epsilon_3 - \epsilon_1)^2} - \end{aligned}$$

are the intensity of tangential stresses and the intensity of the deformation rate of shear; and $\sigma_m = 1/3 (\sigma_1 + \sigma_2 + \sigma_3)$ is the average normal stress.

Equation (12) defines the dependence of the deformation rate on stress and describes changes in this rate with time. The parameters of these equations include the characteristics of strength (r_0, H_0, ψ).

From equation (12) we can easily obtain the equation of creep:

$$\gamma_i = \gamma_i(0) + \frac{1}{\eta_0} \int_0^t \frac{r dt}{(t+1)^{n(r)}}, \quad (13)$$

where $\gamma_i(0)$ is the conditionally instantaneous deformation. At $r = \text{const}$ and $n(r) \neq 1$ we have:

$$\gamma_i = \gamma_i(0) + \frac{r}{\eta_0 [1 - n(r)]} [(t+1)^{1-n(r)} - 1]. \quad (14)$$

As we can see, the nature of deformation changes in relation to the value of $n(r)$, i.e. in relation to the stress level

$$\bar{r} = r/(r_0 - r) = \frac{\lambda_2 - n}{\lambda_1}.$$

At $n < 0$, which corresponds to $\bar{r} > \lambda_2/\lambda_1$, the deformation rate increases indefinitely: $\dot{\gamma} \rightarrow \infty$ (curve 1, Figure 1). This increase may be accelerating ($n < -1$), may be constant ($n = -1$), or may be decreasing ($n > -1$).

At $n = 0$, which corresponds to $\bar{r} = \lambda_2/\lambda_1$, $\dot{\gamma} = \text{const}$ and there is stabilized flow (curve 2).

At $n > 0$, which corresponds to $\bar{r} < \lambda_2/\lambda_1$, the deformation rate decreases: $\dot{\gamma} \rightarrow 0$, but deformation itself increases indefinitely. If $n < 1$, deformation increases in accordance with the exponential law (14) and if $n = 1$, in accordance with the logarithmic law:

$$\dot{\gamma}_i = \gamma_i(0) + \frac{r_i}{\eta_0} \ln(t+1). \quad (15)$$

Both these cases (curve 3) are sometimes called "accelerating creep".

Finally, at $n > 1$, which corresponds to $\bar{r} < \frac{\lambda_2 - 1}{\lambda_1}$, there is attenuating creep and stabilization of deformation in accordance with the following law:

$$\gamma_i = \gamma_i(0) + \frac{r}{\eta_0(n-1)} [1 - (t+1)^{1-n}]. \quad (16)$$

At

$$t \rightarrow \infty \gamma_i(\infty) = \gamma_i(0) + \frac{r_i}{\eta_0(n-1)} = \text{const.}$$

Comparison of data calculated from the aforementioned equations with the results of creep tests on frozen soils under uniaxial compression is shown in Figure 2. The same Figure shows a comparison of calculated data with the results of pure shear tests on unfrozen clay (during torsion).

Thus equation (12) describes different processes of deformation of frozen soils; the transition from one process to another depends on the stress level. It is possible to single out two critical values of this level:

$$\bar{r}_{s(1)} = \frac{\lambda_2 - 1}{\lambda_1} \tau \quad \bar{r}_{s(2)} = \lambda_2 / \lambda_1.$$

At stresses less than $\bar{r}_{s(1)}$, creep is attenuating and the stress $r_{s(1)}$ can be regarded as the creep limit. At stresses $\bar{r}_{s(1)} < \bar{r} < r_{s(2)}$, there is "accelerating creep", which is developing at a decreasing rate, but deformation is increasing indefinitely. At $\bar{r} \geq \bar{r}_{s(2)}$, there is flow at a constant or an increasing rate terminating in failure. The stress $\bar{r}_{s(2)}$ can be regarded as the limit of long-term strength $\bar{r}_{s(2)} = \bar{r}_\infty$.

The pattern of long-term failure and the relation of long-term strength to the duration of loading can be obtained from the first equation (5) having transformed it to:

$$\int_{W_0}^{W_r} \frac{dW}{1-W} = \kappa_1 \int_0^{t_r} \frac{dt}{t+1}. \quad (17)$$

Solving this equation we obtain

$$\frac{r}{r_0 - r} = \frac{\nu}{\ln(t_2 + 1)} \quad \text{или} \quad r = \frac{\beta}{\ln \frac{(t_2 + 1)}{B}}, \quad (18)$$

where

$$\nu = \frac{1}{\kappa_1} \ln \frac{1 - W_0}{1 - W_r}; \quad B = e^{-\nu}, \quad \beta = \nu r_0.$$

This equation was examined in detail in a previous communication (Vyalov, 1973).

Within a small range of stress changes, the parameter n in equation (12) can be conditionally taken as constant, while any additional effect of the stress can be allowed for by introducing a power relationship between $\dot{\gamma}$ and r . Equation (12) will then assume the following form:

$$\dot{\gamma} = \frac{1}{\eta_0} r^{1/m} t^{-n}, \quad (19)$$

which corresponds to the well-known empirical formula.

In conclusion let us examine the deformation process as a function of the temperature of frozen soil.

According to formula (12), the temperature θ (K) is included in the following parameters:

$$\eta_0 = A e^{U_0/k\theta}, \quad A = \frac{6k\theta t_0}{V} \quad (20)$$

and

$$n = \lambda_2 - \lambda_1 \frac{r_1}{r_0 - r_1} = \frac{1}{k\theta} \left(\bar{\Omega} - \bar{W} \frac{r}{r_0 - r} \right), \quad (21)$$

where

$$\lambda_1 = \frac{\bar{W}}{k\theta} = \frac{1}{\nu k\theta} \ln \frac{1 - W_r}{1 - W_0};$$

$$\lambda_2 = \frac{\bar{\Omega}}{k\theta} = \frac{\kappa_e (1 - \Omega) dU_0}{k\theta d\Omega}.$$

Let us first examine the dependence of the viscosity coefficient on the temperature as given by equation (20).

Since the first factor, A , is linearly dependent on θ , whereas in the second factor, $e^{U_0/k\theta}$, θ appears in the exponent, i.e. the effect of θ on e is considerably stronger than on A , we can assume that $A = \text{const}$, as it was done in the Frenkel theory of viscosity. Further, to allow for the experimentally determined dependence of \bar{U} on the temperature, Dillon and Andersland (1967) expressed U with the help of the following equation:

$$U = H_3 - \theta S, \quad (22)$$

where S is entropy, while H is enthalpy (the heat of activation). From this we obtain

$$\eta_0 = A \exp \left[\frac{1}{k} \left(\frac{H_2}{\theta} - S \right) \right]. \quad (23)$$

It is obvious that equation (23) holds only at $\theta < \theta_0$, where θ_0 is the temperature of thawing of frozen soil, since at $\theta = \theta_0$ the energy related to the phase transitions of ice should be allowed for. Therefore, η_0 should be referred to the temperature of thawing, denoting η_0 at $\theta \rightarrow \theta_0$ by η_0^* :

$$\eta_0^* = A \exp \left[\frac{1}{k} \left(\frac{H_2}{\theta_0} - S \right) \right]. \quad (24)$$

We can set

$$A = \frac{6k\theta_0 t_0}{V} = \text{const.}$$

Then

$$\eta_0 / \eta_0^* = \exp \left[\frac{1}{k} \left(\frac{H_2}{\theta} - S \right) \right] / \exp \left[\frac{1}{k} \left(\frac{H_2}{\theta_0} - S \right) \right],$$

From this

$$\eta_0 = \eta_0^* \exp \left[\frac{H_2}{k\theta_0} \left(\frac{\theta_0}{\theta} - 1 \right) \right]. \quad (25)$$

The dependence of viscosity on the temperature in accordance with equation (25) is shown in Figure 3. Let us note that at $\theta = \theta_0$ there are spasmodic changes in viscosity.

Figure 3

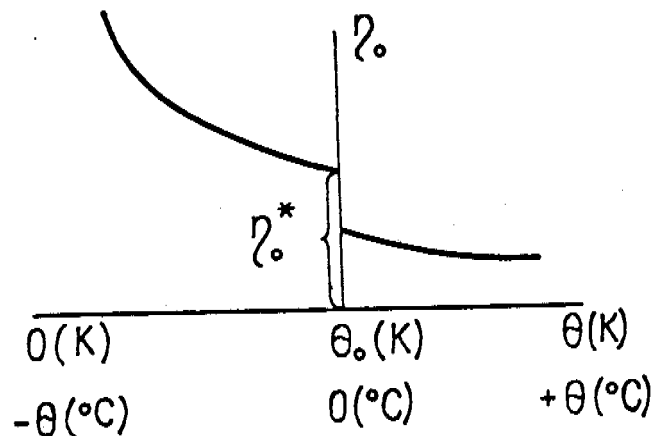

η_0 vs. temperature

Let us now examine the effect of the temperature on the exponent n . According to (21), n is inversely proportional to θ . But at the same time, the instantaneous strength r_0 included in equation (21) is also dependent on θ and it can be shown (Vyalov, 1973) that this dependence has the following form:

$$r_0 = \alpha(H_0 + \theta S) / k\theta \ln \frac{t^* k \theta}{\delta h}. \quad (26)$$

As the temperature increases ($\theta \rightarrow \theta_0$), the value of r_0 decreases. Hence the exponent n decreases also and depending on the ratio of terms $\bar{\alpha}$ and $\bar{W} \frac{r}{r_0 - r}$ in equation (21) this exponent may vary from $n < 0$ to $n > 0$. The deformation curves will change in accordance with the temperature (see Figure 1). Let us note that the value of n should refer to the temperature of thawing θ_0 , as in the case of η_0 .

Thus, the generalized deformation equation (12) makes it possible to describe various forms of creep of frozen soils - from attenuating to progressive creep terminating in failure. The nature of creep will depend on the applied stress and the temperature of soil. Furthermore, equation (12) makes it possible to allow for stress which varies with time and for variable temperature. This is done by introducing $r = r(t)$ and $\theta = \theta(t)$. Changes in r and θ may lead to changes in the nature of deformation. For example, with increasing r and θ , attenuating creep may be transformed to progressive creep, and vice versa, as has been confirmed by experiments.

REFERENCES

- VYALOV, S.S. Long-term failure of soil as a thermoactivated process. II Int. Conference on Permafrost. Issue 4, Yakutsk, 1973.
- VYALOV, S.S., PEKARSKAYA, N.K. and MAKSIMYAK, R.V. On the physical nature of processes of deformation and failure of clay soils. "Osnovaniya, fundamenty i mekhanika gruntov, No. 1, 1970.
- ANDERSLAND, O.B. and AKILI, W. Stress effect on creep rates of a frozen clay soil. Geotechnique, 1967, v. 17, No. 1, pp. 27-39 1967.
- DILLON, B. and ANDERSLAND, O.B. Deformation rates of polycrystalline ice. Proc. Int. Conf. on Low Temp. Science. Sapporo, v. 1, p. I, pp. 313-327, 1967.
- MITCHELL, I.K., COMPANELLA, R.G. and SINGH, A. Soil creep as a rate process. SMFD, ASCE, 1968, v. 94, NSM-1, pp. 231-253.

PERMAFROST INVESTIGATIONS IN PIPELINE CONSTRUCTION

V.V. Baulin, G.I. Dubikov, Yu.T. Uvarkin
Industrial and Scientific Research Institute for
Engineering Surveys in Construction, Moscow, U.S.S.R.

and

L.S. Garagulya, V.V. Spiridonov
All-Union Scientific Research Institute of the
Construction of Trunk Pipelines, Moscow, U.S.S.R.

The development of oil and gas deposits in the North has brought about a sharp increase in the volume of special permafrost research. This research is based on standard permafrost surveys but includes special features dictated by the specifics of the structure to be built (its design and operating regime). Trunk pipelines, which often cross different permafrost zones and have various temperature regimes in different sections, interact with the soils of the seasonally freezing or thawing layer and their effect is limited by the portion of the permafrost whose temperatures fluctuate annually. This range of depths is characterized by a variable hydrothermal soil regime, which alters their mechanical and thermophysical properties, as well as activating permafrost processes. In connection with this, the design of pipelines in regions of widespread permafrost takes into account not only the characteristics of the permafrost which were obtained during the survey but also the possible changes in permafrost conditions during construction and operation. Such changes occur very rapidly, during the course of intervals of time which are commensurate with the periods of operation of the structures, and can result in irreversible changes along the pipeline routes and adjacent areas. These changes often have an unfavorable effect on the structure and ecological conditions of large areas. Multiple pipeline construction and operating experience show that changes in natural conditions occur in a strip whose width is comparable to that of river valleys. Measures limiting the

effect of pipeline construction on the environment, or measures which control such effects, are an important task for the national economy inasmuch as this makes use of the possible systems and ensures the necessary ecological conditions. Such measures include: selection of the best pipeline route, optimum design solutions, and construction techniques, taking into account the natural conditions, development and implementation of protective measures, and land improvement. In order to carry out the above measures, studies are carried out of the main principles of permafrost formation and of the engineering and geological conditions, and also the individual and combined effects of various natural factors on the above; forecasts are made of the changes in natural conditions along the pipelines during the period of construction and throughout the period of operation. Such information is the basic content of the permafrost, engineering and geological surveys which are carried out at all stages in the design of trunk pipelines.

Publications of the All Union Scientific Research Institute for the Construction of Trunk Pipelines, the All Union Scientific Research Institute of Hydrology and Engineering Geology, the Industrial and Scientific Research Institute for Engineering Surveys and Construction, the State Institute for the Planning of Foundations and Underground Structures, Moscow State University, and the experience of design and survey organizations of the Ministry of the Gas Industry, U.S.S.R., were all used in the preparation of this report.

PERMAFROST RESEARCH FOR TECHNICAL AND ECONOMIC VALIDATION OF TRUNK PIPELINE CONSTRUCTION

There is no consensus on the need to carry out permafrost studies on which to base the construction of trunk pipelines in the northern part of the Soviet Union. The situation is similar with respect to the requirements for basic information, which must be known in order to select the best pipeline routes. Recent design survey and scientific research practice, however, show that the selection of the best pipeline routes and construction methods for laying trunk pipelines must be technically and economically validated on the basis of permafrost surveys (at a scale of 1 : 100,000 - 1 : 200,000) carried out along possible routes. A chart of the

operations required to accomplish this in unsurveyed areas with complex permafrost conditions is shown in Table I.

In the first stage of the permafrost studies the available aerial survey data are used to evaluate the permafrost conditions over the entire construction territory (Table II), and initially favorable and unfavorable sections are determined. The following are also evaluated: a) sensitivity of various types of terrain to removal of the ground cover, to the mechanical effects of vehicular traffic, to levelling of the land, to earth moving operations, and to the thermal effects of the pipelines; b) possible regional changes in the terrain, geobotanical, hydrological and hydrogeological conditions during construction and operation of the pipelines; c) the size of the territory over which changes will occur in the natural conditions as a result of the construction and operation of the pipelines.

The most promising routes are chosen on the basis of these evaluations, which ensure, in great measure, the durability of the pipeline and the safety of the environment.

The second stage includes work on the best route variants in order to select the best direction, the best design solutions, to develop the technical regimes for pumping the product, and to select the best measures for controlling the permafrost, engineering, and geological processes. The most important part of this stage is mapping the permafrost along the possible routes, as well as monitoring the permafrost processes and temperature regime of the permafrost in order to establish and quantitatively evaluate the role of individual natural factors in the formation of permafrost. These data are also used in subsequent stages of planning and preparation of the working drawings in order to draw up the permafrost forecast for the period of construction and operation of the pipeline. The cartographic permafrost data which are needed for knowledgeable selection of the best trunk pipeline route over the territory, and in order to substantiate design solutions during this stage, are also collected and partially charted, in addition to data on meteorological conditions, terrain, vegetation, and hydrology. Such data include: a) physico-mechanical properties of the soils; b) lithological composition of the seasonally freezing layer and of the underlying rocks to a

TABLE I

Chart of permafrost research work for validating pipeline construction
in unsurveyed regions of the Far North

Stage	Type	Purpose
Evaluation of permafrost conditions in the proposed construction territory.	<ol style="list-style-type: none"> 1. Collection and analysis of data which characterize the natural conditions. 2. Aerial studies. 3. Laboratory layout using topographic maps. 	Preliminary determination of favorable and unfavorable sections, and selection of the most promising of the possible routes.
Work on possible route variants.	<ol style="list-style-type: none"> 1. Large-scale aerial photographic surveys. 2. Permafrost interpretation of photographic surveys, compilation of a relief map, and selection of "key" sections for field work. 3. Aerial geophysical surveys of the promising route variants, detailed permafrost surveys of the "key" sections, and mapping of the promising route variants to a scale of 1 : 100,000 - 1 : 200,000. 4. Permafrost classification of the route variants by possible pipeline construction methods. 5. Observation of the temperature dynamics of frozen ground, seasonally frozen soils, and physico-geological and "cryogenic" processes. 6. Forecasting of possible changes in permafrost conditions due to climate dynamics and changes in the geo-environment during construction and use of the pipeline structures. 	<p>On the basis of comparison and study of the promising route variants:</p> <ol style="list-style-type: none"> a) selection of the best route, taking into account the design solutions. b) selection of the mode of construction and the method of laying the pipeline over permafrost. c) selection of the area for experimentation and testing. d) selection and validation of the location of permafrost station for carrying out work required by paragraphy 1.5 of the Construction Norms and Regulations II-b. 6-66.

TABLE II

Initial data for preliminary evaluation of the complexity
of the route's permafrost conditions

Main permafrost characteristics	Category of complexity of the route sections	
	Simple	Complex
Distribution over the area	Continuous permafrost Permafrost islands	Discontinuous Large islands
Mean annual temperature	Below -2°	-2° to -0°
Composition and ice content	Rocky and sandy-clayey with low ice content	Sandy-clayey with average and high ice content
Composition and frost susceptibility of the soils	Rocky and sandy-clayey non-frost-susceptible and slightly frost-susceptible $W_c \leq W_{kp}$	Sandy-clayey frost-susceptible $W_c > W_{kp}$
"Cryogenic processes" and frozen ground features	Not widespread	Widespread: ground ice, frost mounds, contemporary thermokarst, icing, solifluction, etc.

depth of 10 - 15 m; c) data on the distribution of frozen and unfrozen soils, their mean annual temperature, depth of seasonal freezing and thawing, thickness of the frozen layer, and thickness of the layer with annual temperature changes; d) data on frozen ground features, and the rate at which the processes involved proceed; e) data on the stratigraphic and genetic affiliation of the deposits and geomorphological elements of the terrain; f) data on groundwater (level, depth, quantity, corrosive properties).

These data are used to do the following: a) calculate the possible changes in the temperature regime of the soil of the main types of terrain traversed by the route, depending on the methods used to lay the pipeline (alternative variants are examined), and various parameters for the regime of pumping the product; b) the rate of development of permafrost, engineering, and geological processes are evaluated, as is their duration in various types of terrain depending on the method of construction and the pipeline regimes; c) changes are evaluated in the regional national conditions along the route, as caused by the interrelation of terrain types with various technologies during construction; d) the effectiveness of measures for controlling processes of change in the natural factors, in order to ensure the stability and safety of the environment, is determined.

PERMAFROST RESEARCH FOR ENGINEERING DESIGN AND PREPARATION OF WORKING DRAWINGS

The type and extent of studies of the chosen route are determined depending on the complexity of the permafrost conditions, the planned method for laying the pipeline, and its design. The permafrost survey is planned on the basis of the above. Complete laboratory interpretation of large scale aerial photographs, including detection of natural signs of permafrost, is carried out during the engineering design stage prior to field investigation of the chosen route. Analyses of reports and other available materials are used to compile a preliminary map of the natural microregions and a schematic permafrost map. An approximate description of the extent of permafrost, its composition, temperature and engineering and geological processes and phenomena, are given for each microregion.

Field studies which are carried out during the engineering design stage of a pipeline project follow the "key" method which is based on microregionalization of the terrain and consists in detailed study of the permafrost in the characteristic (base) sections of the route, which are called "key" sections. Less detailed studies are carried out over the rest of the route (ground, aerial, etc.). The number and area of key sections is determined on the basis of the complexity of permafrost conditions. In zones of epigenetic permafrost 3 to 8 key sections per 100 km of the route are recommended. In zones of syngenetic permafrost, with their characteristic sheet and vein ice, the number of key sections may increase significantly, with a simultaneous increase in the detail of the survey. Thus, in the forest tundra and northern taiga regions of West Siberia, where the most important petroleum and gas deposits are located, the widths of the mapped zone in key sections changes from 2 to 4 km, with a length of 10 km. When crossing large water courses the zone width may reach 10 - 20 km in order to evaluate various areas.

The permafrost survey scale must not be smaller than 1 : 25,000 in key sections. The type and approximate volume of work involved in surveys during the engineering design and work drawing stage are shown in Table III.

The basic requirement of key sections is that they contain all of the microregion types which are encountered along the route. The permafrost studies must cover all of the geological and genetic complexes and all of the types of seasonally and perennially frozen soils which are typical of the region. The mechanisms of change of the permafrost conditions which are observed in the key sections are extrapolated to the entire projected trunk pipeline route. A specific permafrost map of the pipeline construction belt is compiled on this basis. The position of the pipeline axis is established on the basis of the permafrost research during this stage. During the engineering design stage a forecast is made of the changes in the natural conditions, and calculations are carried out of the thermal and mechanical interaction of the pipeline with the foundation soils in order to refine the design solutions and tie them in to the actual conditions along the route, to establish the required strength of construction, to determine the necessary land improvement measures as necessitated by the conditions along the route,

TABLE III
Tentative volume of work along the chosen trunk pipeline route
(with respect to lowlying regions of epigenetic permafrost)

Type	Volume of work required to compile the	
	engineering project	working drawings
Permafrost surveys, including:	Scale of 1 : 25,000 and larger (width of survey zone 2-4 km)	Scale of 1 : 5,000 and larger (width of zone 0.5 km)
1. Interpretation of aerial photographs at a scale of	1 : 17,000 - 1 : 10,000	1 : 5,000
2. Visual aerial surveys	Along the entire route	For complex section requiring clarification
3. Ground studies	3-5 observation points per micro-region within a key section	Up to 20 observation points per 1 km of route depending on the complexity of permafrost conditions
4. Drilling of 10-15 m deep boreholes, core sampling, soil testing and thermal well-logging	At least 2 boreholes per microregion type within the confines of a key section	2-5 boreholes per 1 km of route, depending on the complexity of the permafrost conditions
5. Drilling of logging boreholes to an average depth of 3 m	At least 2 boreholes per microregion type within the confines of a key section	5-8 boreholes per 1 km of route, depending on the complexity of the permafrost conditions
6. Sinking of 1-2 m deep test pits	None	2-3 bore pits per lithogenetic soil type along the route
7. Summetrical electric logging	In key sections at two spreads with lengths of 25-50 m along the route axis and 1-2 across the axis	At two spreads with lengths of 10 m (in sections with 5 m wedge ice) along the route axis, and 2-5 across the axis per 1 km of route
8. Vertical electric logging (VEL)	Number of vertical electric logging points with spreads of AB-200-300 m at key sections is determined by the number of profiling anomalies, but should not be less than the number of detected microregions	Number of vertical electric logging points with spreads of AB-200-300 m should be equal to the number of profiling anomalies, but not less than 5-7 points per 1 km of route

and to work out the operational procedures. Forecasting during this stage includes: a) evaluation of changes in the soil temperature regime and formation of seasonal or long-term areas of thawing (freezing) of the soils of all of the types of terrain crossed by the pipeline, depending on the construction methods and the engineering parameters; b) calculation of the change in the temperature of the wall of the pipe and of the product along the length of the pipeline; c) evaluation of changes in the physical and mechanical properties of the soils along the route in connection with changes in their temperature and moisture regimes; d) forecasting of the development of permafrost, engineering and geological processes, and calculation of their effects on the pipelines and support structures; e) determination of the set of measures for ensuring reliable pipeline operation and protection of the environment along specific sections of the route.

Permafrost studies for the working drawings are carried out along the pipeline axis and are limited to a 0.5 km-wide belt along the entire pipeline route. A wide range of ground level operations is carried out during this stage, predominantly along the axis of the proposed pipeline. The working scale for these surveys is 1 : 5,000. In addition to the special permafrost map, a permafrost cross section is compiled along the route axis, showing the main permafrost characteristics (structure, composition, moisture content, thaw settlement temperature, etc.), as well as a table which summarizes the construction properties.

One of the forecasting tasks during the working drawing stage is verification and correction of the thermophysical and thermal engineering calculations performed earlier, in connection with changes in the position of the route axis, changes in the design solutions, or changes in the operational parameters of the pipeline.

FORECASTING METHODS

Forecasting during the design of trunk pipelines may be performed using the well known methods of modelling, analogy, genetic classification extrapolation, interpolation, and expert evaluation.

Modelling of permafrost and geological processes and situations, as well as the interaction of pipelines with the environment can be logical, mathematical and physical (field and laboratory).

1. Logical models are the first stage in modelling of any type. They use geological concepts and generalizations to express the researcher's ideas on the formation of the permafrost, engineering and geological conditions, and on the interaction of the pipelines with the environment. The possibility of using existing formulations for actual construction is determined, depending on the logical models which are used, and new problems which require additional research are formulated. For this reason logical models are constructed in the early stages of research.

2. Mathematical modelling has become widely used in forecasting processes of interaction between pipelines and the environment at all stages of research. The mathematical models are classified into the determinate and the statistical types. The former include various equations, graphs, and nomograms expressing the functional relation between the characteristics of the soils and processes occurring within them, and the natural factors and parameters of the structure. Determinate model research is carried out using analytical methods and computers. An example of the use of such models for forecasting changes in the permafrost, engineering and geological conditions at all stages of pipeline design, is the method developed at the Permafrost Department, Moscow State University under the direction of V.A. Kudryavtsev. This was found to be a very fruitful method for studying the principles of the formation and dynamics of seasonal and long term permafrost, and attendant processes and phenomena. The specialized methods developed at the All Union Scientific Research Institute for the Construction of Trunk Pipelines for forecasting the thermal interaction of pipelines with permafrost use solutions to Stefan's problem for determinate models to establish the depth of thaw or freezing under the pipe at any given moment. Determinate methods are included among the methods for forecasting permafrost processes developed at the All Union Scientific Research Institute of Hydrology and Engineering Geology.

An advantage of the above method is the possibility of studying a particular process in relation to a large number of variable and interrelated

factors in a relatively short period of time and with minimum manpower requirements. However, inasmuch as determinate models are simplified, the results depend on the accuracy of determination and choice of the initial data obtained during the permanent survey. These problems have been dealt with in papers of the All Union Scientific Research Institute for the Construction of Trunk Pipelines, the All Union Scientific Research Institute of Hydrology and Engineering Geology, and the Industrial and Scientific Research Institute for Engineering Surveys in Construction.

Statistical (probability) models are equations in which independent variable values are given as random variables. Statistical models are more complete than determinate models and correspond more closely to real processes. The difficulty in using statistical models for forecasting changes in permafrost, engineering and geological conditions along pipeline routes presently lies in the absence of the necessary data for describing the probability of events and properties which determine the situation being forecasted. Work on the use of such schemes is being carried out by the State Institute for the Planning of Foundations and Substructures and by Moscow State University.

3. Physical (natural) modelling can include experimental research at test sections and in operational areas. The advantage of this method lies in the fact that permafrost, engineering and geological processes and phenomena whose action is expected along the route are reproduced in an undistorted form in such models. The long experimentation time and the need to devise a large number of models in order to study the effect of various natural factors individually and in specific combinations on the operation of the pipelines limits the use of this method, especially in solving problems which already have developed and researched mathematical models. Natural modelling is of significance in solving special problems of the interaction of pipelines with the environment and for verifying the validity of forecasts of changing conditions arrived at by other methods. Natural models should be studied at all stages of research.

Reliable results can also be obtained by studying laboratory models. Laboratory testing of soils is irreplaceable for forecasting changes

in their properties. When dealing with certain problems of the interaction between pipelines and soils under laboratory conditions it is difficult to ensure a similarity between the model and the actual site. In such cases full scale models must be created and tested.

Laboratory modelling can also include the modelling of processes with the aid of analog machines. In this case the process under study is replaced by any other (for example, hydraulic, or electrical), which has an analogous mathematical expression. Analog modelling is, to a significant extent, an abstraction of the actual site inasmuch as analog installations essentially solve mathematical equations.

Installations based on the system devised by V.S. Luk'yanov are widely used for studying the mechanisms of permafrost formation along pipeline routes, and changes in them as the pipelines are built. Analog modelling of these processes is carried out mainly during the engineering design and working drawing stage in order to solve complex, non-standard problems, to study the dynamics of thermal process, and to check results obtained by approximation.

The next method of forecasting the interaction of pipelines with their environment, used at all stages of research, is the method of analogies. Using this method changes in the natural conditions of future building sites are forecast on the basis of study of similar structures which have been built in similar areas, having comparable permafrost, engineering and geological conditions prior to construction. Study of past building experience can be conducted either during routine field investigations of existing pipeline routes or by aerial surveys. The method of analogies is of a predominantly qualitative nature. The quantitative evaluations which are obtained by means of it are approximations. This method does, however, have certain advantages over modelling.

The results of forecasting changes in natural conditions by means of modelling methods pertain to a specific area; they apply to a particular type of terrain and to a specific pipeline cross section. Such forecasting reflects the interrelation of factors and processes within the confines of a

particular type of terrain, and every terrain type bears a particular relation to the types of terrain which surround it. For this reason, changes in the natural conditions along individual sections of the route can result not only from the direct effect of construction work, but also by changes in the condition of adjoining sections. Surface and groundwater, for example, exhibit a regional character. In areas of excess ground moisture the pipeline routes begin to act as drains, channelling surface and groundwater. Change in the soil moisture regime and the appearance of a seasonal or constant ground flow gives rise to active erosion and undermining, and to alteration of the relief of the pipeline route. Flooding along the route results in changes in the plant communities, alteration of the salt content of the soil, etc. Similar regional changes can be forecast only by studying the interrelations of various terrain types and changes in them which are caused by the construction of pipelines.

Using building experience and repeated aerial photographic surveys, the method of analogies can successfully be used to forecast such regional changes in the natural conditions.

Forecasting of the extent and nature of permafrost processes, taliks, and wedge ice is performed, using genetic classification, on the basis of their cause and effect nature. This is possible because they reflect the necessary conditions for the appearance and development of the process. This is a good method and is used primarily during the early stages of research to evaluate conditions along alternate routes.

Extrapolation and interpolation are used during all stages of research both to forecast changes in the natural conditions during the period of construction and for spatial changes. Spatiotemporal extrapolation is often used. A necessary condition for extrapolation is a demonstration that the tendencies toward change in the process, which were established in the tested interval, are preserved in the interval (temporal or spatial) over which extrapolation is being carried out. For long future time periods and for regions (areas) which are inaccessible to testing it is extremely difficult to demonstrate that the tendencies remain unchanged. For this reason the method of extrapolation is of limited use in geology. In the study

of permafrost and in engineering geology, however, forecasting of many transient processes would not be possible at all if it were not for this method. The extrapolation method is used with particular success when the functional dependence of parameters on time, as expressed mathematically, is studied.

Extrapolation accuracy, as applied to evaluation of changes in pipeline operating conditions, is made possible by the fact that the area of research is accessible to observations and because the forecast period does not exceed 30 - 40 years. The possibility of making observations during the period of operation permits corrections to be introduced into the forecast.

The peculiarities of the interpolation method are the same as those of the extrapolation method.

The method of expert evaluations is based on using the professional experience, knowledge, and intuition of highly qualified permafrost experts, geological engineers and designers working in this field. This method is used to forecast changes in the natural conditions along pipeline routes, in the same way as is the logical modelling method, during the initial stages of research in order to establish all aspects of the operational reliability of the oil or gas transport system, which is simultaneously affected by many factors. The expert evaluation method is used for high-calibre study of general problems which often arise in first-time construction. Expert evaluations are used to select the techniques, methods, and equipment for studying and predicting the permafrost, engineering and geological conditions during later stages of research.

In conclusion, it should be mentioned that a combination of the methods listed above should be used to solve all of the indicated problems of forecasting changes in the natural conditions along pipeline routes at all stages of research. The place and significance of each method, however, and the work entailed in using one or another of the methods, are different. The organization of the test sections, the conduct of experimental work in the early stages of research, and organization of the permafrost service along operational pipelines, all have an important effect on forecasting.

CHARACTERISTICS OF THE CONSTRUCTION OF FROZEN DAMS IN WESTERN YAKUTIYA

G.F. Biyanov

All-Union Planning, Surveying and Research Institute, Moscow

V.I. Makarov

Permafrost Institute, Yakutsk, U.S.S.R.

The development of the mining industry in Western Yakutiya has necessitated the construction of hydraulic structures in order to supply water to settlements and industrial enterprises. The hydraulic regime of the water courses in this region is highly irregular, with most of the flow occurring in spring and summer and with practically no flow in winter. Year round supply of water requires the creation of reservoirs whose volume is based on both current requirements and long term development of the region. Frozen dams, 30 m high, were found to be the most suitable for this region from both the economic and engineering points of view. Certain features of the construction of such dams, based on practical experience gained during the building of water engineering systems on the Irelyakh and Sytykan Rivers and on Oiuur-Yurege Creek, are examined below.

Western Yakutiya has a continental climate with a mean annual temperature of -8 to -12°C , and widespread bouldery and stony soils which are highly weathered to a great depth and which exhibit significant settlement upon thawing. Talus deposits along valley slopes usually consist of loam with a significant content of rock debris and bedrock grus, the thickness of the deposits usually being correlated with the seasonal depth of thaw. Alluvial deposits in the floodplains of rivers contain sand, sandy loam, rock debris and shingle, and mud. Their ice content may be as high as 60%.

The water engineering system includes the frozen dam, spillway, road across the dam, and pumping station, which is usually located in the headwater at a considerable distance from the dam.

All three of the above mentioned water engineering systems have the same layout, with the spillway located on the valley slope and the bridge across the spillway channel located near the spillway gate. Detailed descriptions of these structures are available in the literature (Biyarov, 1975) so only such data will be examined below which are of interest from the point of view of correlating experience in the design, construction, and operation of such water engineering structures.

DAMS OF THE FROZEN TYPE

The dams of the three water engineering systems which will be examined are of different geometrical dimensions, but they are sufficiently similar in design to make it possible to present them as a single generalized design scheme (Figure 1). These dams have a broad profile, the lower slope being 1:2 and the upper slope being from 1:3 to 1:4. Berms are built on the slope of the upstream fill to make provision for thaw settlement of the base. The crest width of the dam is determined on the basis of the locations of the permafrost face and the road across the dam.

Figure 1

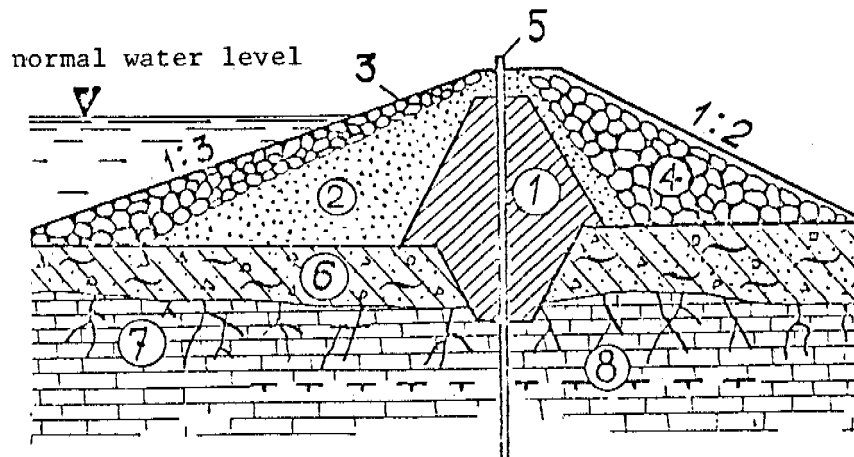

- Generalized profile of the dam constructed in Western Yakutiya
- 1) - rocky loam core; 2) - gravel-sand fill; 3) - rock facing;
 - 4) - rock fill; 5) - coaxial column of refrigeration system;
 - 6) - frozen alluvial deposits; 7) - weathered bedrock;
 - 8) - talik boundary beneath the riverbed.

A characteristic feature of the design of the dams which have been built is a loamy core, with a cutoff which cuts through the frozen alluvium of the base down to bedrock. The core is construction of stony loam which is compacted in layers. The core is weighted down on the headwater side with a sand facing, which prevents piping of the core material when the headwater level fluctuates. The sand facing of the core on the tailwater side acts as a filter material in the vent of seepage through the supporting mass.

The cutoff of the stony loam core, which cuts through the frozen alluvium down to the bedrock, is intended to prevent catastrophic settlement of the central portion of the dam in the event of water seepage through the dam's supporting mass and base.

Thus, although the dams which have been built were designed as frozen dams, their construction permits them to operate in the thawed state. This approach ensures high reliability of the dams, but not of the water supply. If water begins to seep through the supporting mass there will be unavoidable thawing of the base, which in our case consists of fractured bedrock whose coefficient of percolation in the thawed state may reach hundreds of meters per day. Inasmuch as the reservoir volume is established without taking water lost by seepage into account, thawing of the base may result in premature exhaustion of the water supply in winter, when there is no inflow of water to the reservoir. The principal method of preventing this situation is the timely creation of a reliable frozen curtain.

In those cases when the dam is designed to be stable in the presence of seepage, the frozen curtain become a secondary element which provides the dam with additional stability. The techniques of frozen dam construction are in accordance with the above situation.

TECHNOLOGY OF FROZEN DAM CONSTRUCTION

The construction operations involved in erecting the dams under discussion were carried out in a definite sequence: 1 - excavation of a trench and placement of loam into the cutoff of the core; 2 - erection of the bank sections of the dam while maintaining a gap for flood discharge in the

riverbed section; 3 - assembly of the refrigeration systems and creation of frozen curtains in the bank sections of the dam prior to filling of the gap; 4 - completion of the riverbed section of the dam, with subsequent freezing of the talik beneath the riverbed and of the loam core in this most vital section of the dam.

This last, hydrometeorologically most important, operation is intended to be carried out in a single winter. Thus, a delay in the completion of the earth moving operations results in insufficient time being available for the creation of a reliable frozen curtain. This was, in fact, the situation which occurred during the construction of the Irelyakh and Oiuur-Yurege dams. In the first case through seepage resulting in thawing did not occur thanks to the high quality of the work and the high imperviousness of the thick loam core. In the second case there was no through seepage resulting in thawing thanks to the low negative temperatures of the broad retaining fill of the dam, which was placed in winter. Figure 2 shows the temperature distribution across the bed profile of Oiuur-Yurege Creek. By the end of construction the entire dam was frozen with the exception of part of the loam core and a narrow layer along the bottom of the upstream fill. There was no continuous frozen curtain in the loam core of the dam as the reservoir filled.

Figure 2

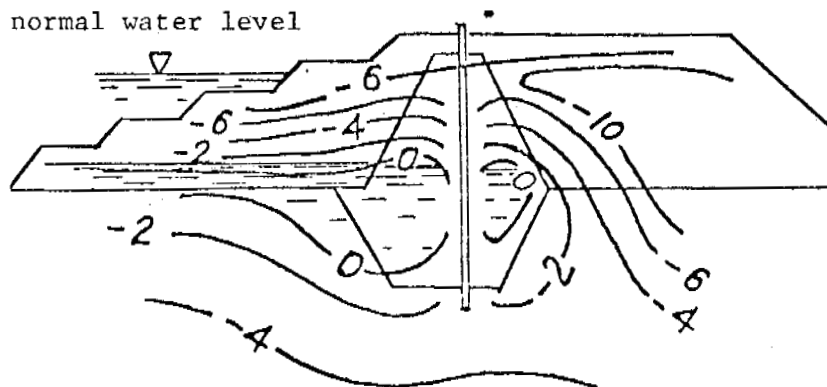

Temperature field in the bed profile of the dam on Oiuur-Yurege Creek at completion of construction (April 1972).

The source of groundwater which was found in the core cutoffs of all three dams is of interest from the point of view of the construction operations and in order to ensure percolation stability of dams. The appearance of groundwater in the core cutoff of the Oiuur-Yurege dam, and their emergence at the foot of the upstream fill, were a cause of concern with respect to the percolation stability of the dam. In order to establish the source of the groundwater the Institute of Geocryology conducted a special geophysical survey. This survey revealed that there were no external sources of the groundwater which was found in the core cutoff. Analysis of the data, collected by the laboratory at the construction site to monitor the quality of the loam used for the core, made possible a preliminary explanation of the origin of the groundwater in the core of the dam. The local loam is supersaturated and contains a large quantity of stony material. When the moisture content of such material is determined without removal of the stony fraction the result obtained is lower than the actual moisture content of the loam used for the core. A rough calculation of the actual situation showed that each cubic meter of loam used in the core contains approximately 100 liters of gravitational water which flows down and collects in the bottom of the trench for the dam's core cutoff. The hydrostatic pressure increases in the localized water saturated zone as the supporting mass of the dam freezes, which explains the pressure of the groundwater in holes which are drilled down to taliks.

When a reliable frozen curtain is created in the supporting mass and base of the dam the appearance of groundwater in the core does not present a danger.

In the dam under discussion, freezing of the loam core was observed from the low-temperature earth used for the retaining fill. Dam construction experience shows the advisability of constructing the retaining fill and facing in winter. By using this method it is possible to omit the creation of frozen curtains in the bank sections of dams if there is ground with low ice content in the base.

The technology of construction of the Sytykan dam is of significant interest from the point of view of improving the methods of building dams of

the frozen type. The dam was built in two phases. The construction methods which were used in the first phase do not differ from those reported previously. The bold decision to discharge floods over the crest of the uncompleted dam merits attention. Despite minor deformation and erosion of the unfinished dam, two floods (one of which was double the estimated magnitude) were successfully discharged over the crest. The refrigeration columns were installed in the dam upon completion of the first phase of construction. Thus, as the dam was built up to its full profile, the columns were also extended. Experience revealed the technical and economic advisability of erecting the dam with advance construction of the refrigeration system. This method of construction was used only during the second phase of construction, but in principle it is the more suitable method in the construction of frozen dams.

The method of dam construction with advance installation of the refrigeration system is the most suitable for dams of the frozen type. It is important that the refrigeration system function not only after construction of the dam is completed but also while it is being built. Advance installation of the refrigeration systems makes it possible to alter significantly the techniques of frozen dam construction. The sequence of construction operations using this method is as follows: 1 - removal of the ground cover in the frozen curtain zone; 2 - drilling of holes and installation of all refrigeration columns, including protection from ice flow in the area of the riverbed (these operations are carried out regardless of the time of year); 3 - construction of the bank sections of the dam in summer; 4 - construction of the riverbed section of the dam in winter (with the refrigeration system in operation).

This method is based on the high reliability of the frozen curtain, which is created simultaneously with the construction of the dam. The reliability of the frozen curtain makes it possible to alter the construction of the dam. It becomes unnecessary to construct a loam core cutoff inasmuch as the imperviousness of frozen alluvial deposits does not differ from the imperviousness of frozen loams. Elimination of the possibility of percolation through the supporting mass of the dam makes it possible to lower the requirements with respect to materials and quality of placement. It

appears to be possible to use frozen earth for the construction of the core as long as the pores are filled during placement with unfrozen earth, water or grout.

The need to ensure operation of the refrigeration system during construction of the dam in winter makes it advisable to use special refrigeration facilities with natural circulation of the thermal carrier, namely thermosiphons.

REFRIGERATION SYSTEMS

Frozen curtains were created in the early frozen dams with the aid of coaxial columns through which brine (cooled either by a refrigerator or cold atmospheric air) was pumped. The high cost, complexity of operation, and accidents involving the leakage of brine into the earth, made it necessary to reject this method of freezing the earth.

Until recently, the most widely used refrigeration systems were those in which cold atmospheric air was used as the thermal carrier in winter. The ground was frozen with the aid of coaxial columns which were installed in holes drilled from the crest of the dam.

The individual columns were connected to an air duct through which cold air was forced by fans. Refrigeration systems of this type were used in the construction of a series of dams which are in successful operation at the present time. Experience has shown, however, that the cost of operating refrigeration systems which use air is quite high and their reliability is inadequate inasmuch as the columns gradually become clogged with ice. Clearing of the columns is laborious and expensive. In recent years, double manifold refrigeration systems have been used in Western Yakutiya with the aim of improving air refrigeration systems. Schematic diagrams of single manifold and double manifold air refrigeration systems are shown in Figure 3. The double manifold scheme ensure uniform distribution of air in the columns without special regulators. This contrasts with the single-manifold system in which the output of air is regulated by special slide dampers while the system is in operation. In addition, the double manifold system is simpler and can

Figure 3

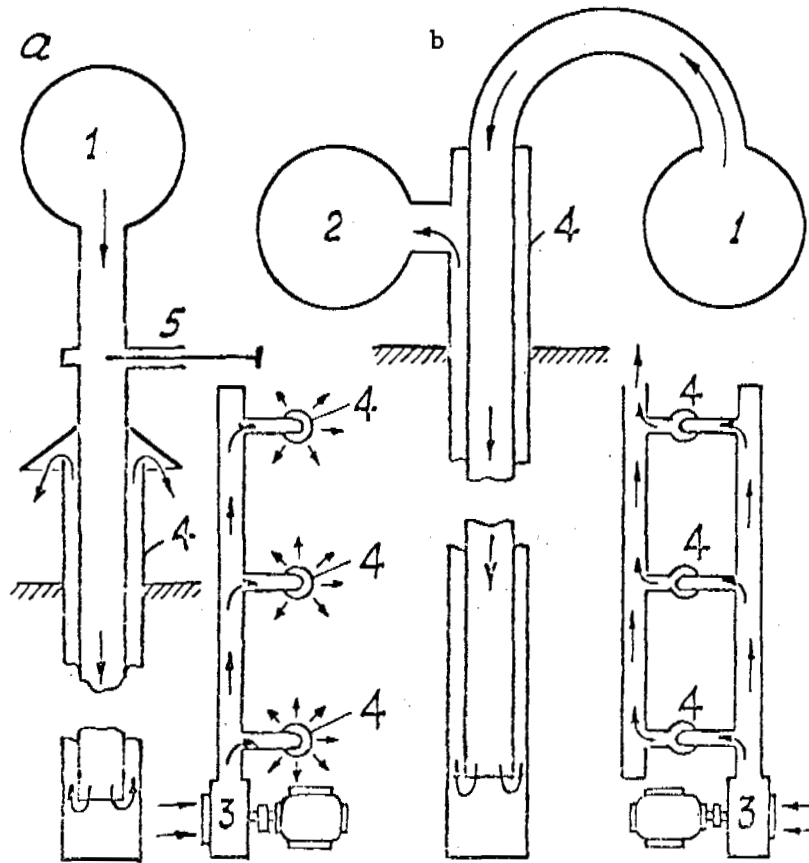

Basic air refrigeration system schemes:
a) - single-manifold; b) - double manifold.
1) - discharge manifold; 2) - draw-off manifold 3) - blower with electric motor; 4) - coaxial column; 5) - slide damper for regulating air to the column.
The arrows indicate the direction of air flow.

be sealed more reliably in summer since this requires that only the manifold input vents be closed off, and does not require each individual column to be sealed off, as in the single manifold system. The first hydraulic engineering application of the double manifold system was in the construction of the dam across the Oiuur-Yurege. Experience has shown that the columns become blocked significantly less often than with single manifold systems, but the possibility of blockage is not eliminated.

The shortcomings of air refrigeration systems prompt the search for better engineering solutions. In 1972-1973 refrigeration equipment with natural circulation of the thermal carrier - thermosiphons - were used at the dam of the Sytykan hydrosystem in order to create a backup frozen curtain.

Part of the equipment used a one phase thermal carrier (kerosine), and the other part was to have used a two phase carrier (liquid ammonia). The first group of thermosiphons was charged with the thermal carrier at the end of February and functioned normally through the end of April. The second group was not in operation due to difficulties associated with charging of the thermal carrier, although the equipment was assembled simultaneously with that of the first group.

Thermosiphons using liquid, and with coaxial columns spaced 2 m apart and extending 26 m into the ground, achieved link up of the frozen ground cylinders from adjacent columns in 40-52 days in water saturated loam

Figure 4 shows a schematic representation of the thermosiphons used at the Sytykan dam.

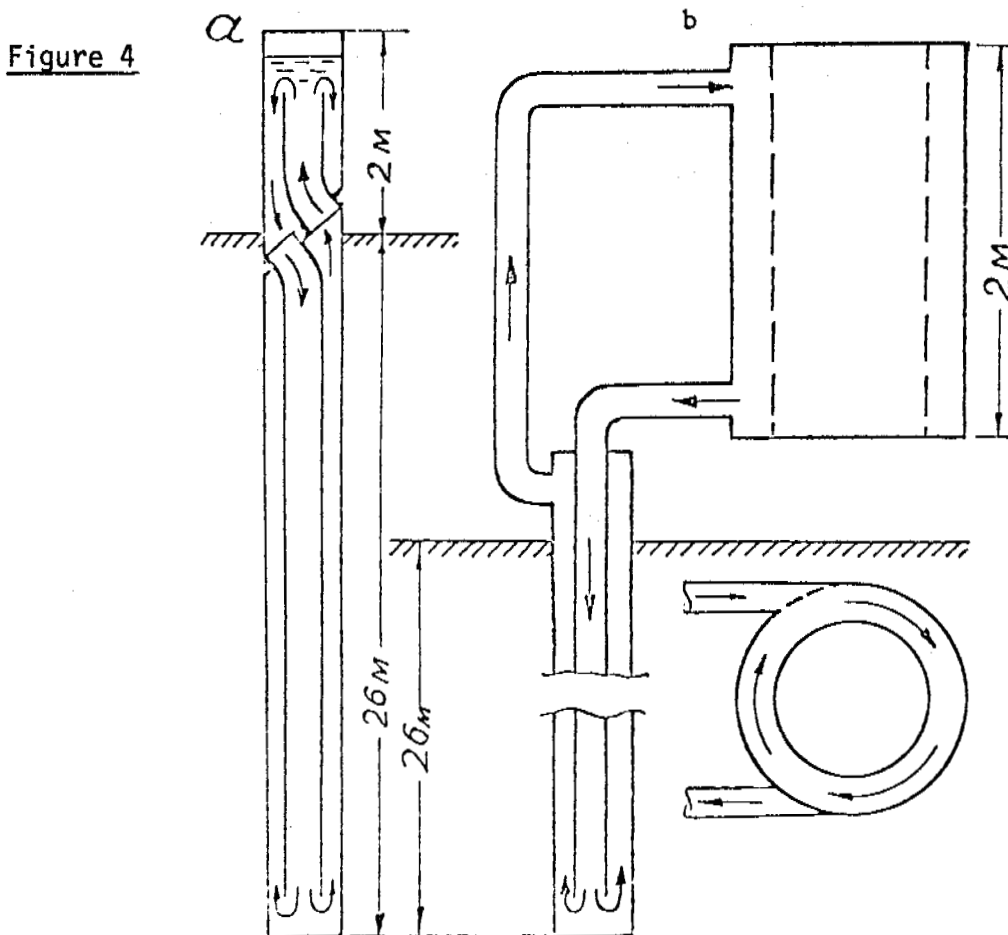

Schematic diagram of thermosiphons used to create a backup frozen curtain in the river-bed section of the Sytykan dam.

- a) - coaxial design thermosiphon using liquid;
- b) - as in (a), with an above ground annular heat exchanger.

Figure 5

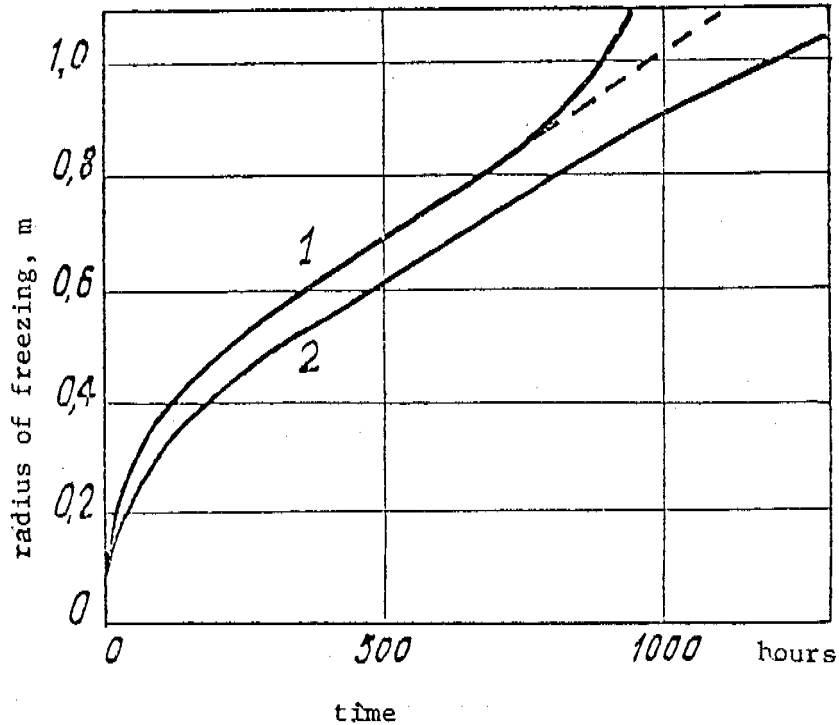

Increase in the size of frozen ground cylinders, as a function of time, around the coaxial refrigeration columns of thermosiphons of the liquid type.

Figure 5 shows data of observations of the dynamics of the zero isotherm shift in the plane of the barrels of the coaxial refrigeration columns of thermosiphons which operate on liquid. The indicated results show the dynamics of the growth of cylinders of frozen ground in the loam core of the Sytykan dam at a depth where the loam is fully saturated with water. Curve 1 shows the dynamics of the growth of frozen ground cylinders at each pair of 219 mm diameter cylinders. It may be seen from the graph that interaction between columns becomes evident only after a particular moment, when the distance between the frozen ground cylinders becomes smaller than one quarter of the distance between the columns. The rate at which the zero isotherms approach each other in the plane of the column barrels increases as the remaining distance between the zero isotherms decreases. If we arbitrarily extend curve 1 (broken line), maintaining the shape it had up to the moment that the influence of the adjoining column became evident, we can determine that the interaction of the columns decrease by 15% the time from the start of refrigeration to link up of the frozen ground cylinders. Figure

2 shows the dynamics of growth of a frozen ground cylinder for a single 159 mm diameter column under the same conditions.

In view of the positive experience of the creation of a backup frozen curtain at the Sytykan dam, the use of thermosiphons of the liquid type is recommended in hydraulic engineering construction under the conditions of Western Yakutiya. At present, plants have been approved and construction has begun on two dams with frozen curtains which are to be created with the aid of thermosiphons of the liquid type.

The use of thermosiphons of the liquid type makes it possible not only to improve the reliability of frozen curtains and lower the costs of operating the refrigeration system, but it also makes it possible to change the methods of construction of frozen dams. Thermosiphons of the liquid type can be used for the advance creation of frozen curtains since they go into operation practically from the time that the columns are lowered into the holes which are bored prior to the start of construction of the dam. The construction of dams with freezing of earth as it is placed into the supporting mass of the dam makes it possible to lower the requirements with respect to the quality of compaction, which permits a sharp decrease in the time and cost of construction of earth dams, and in their complexity.

SPELLWAY STRUCTURES

The traditional configuration of northern water engineering structures, with the spillway located on the slope of the river valley, makes it necessary to cut the spillway channel deep into bedrock.

Mountainous bedrock in the North is usually severely broken on the surface. The content of ice in the material which fills the cracks of bedrock increases with depth until, after a certain depth, pure ice is encountered. When such rocks thaw they are highly pervious. The coefficient of percolation in the thawed base of the spillway channel at the Irelyakh dam, for example, is in excess of 300 m per day. Percolation through rocks of this type results in the rapid thawing of underlying frozen layers.

When free drainage is possible for the water contained in the cracks of rocks which thaw out in summer the cracks empty themselves out and such ground freezes during the next cold season. During the spring floods, the water which enters the rock mass through the cracks raises the temperature above freezing almost instantaneously. The penetration of the water down to the boundary of the previous season's thaw results in the intense annual progress of the zero isotherm into the rock mass. Areas which do not freeze in winter appear as early as after the first season.

The circumstances described above resulted in the formation of a large talik in the base of the spillway channel of the Irelyakh dam. Measurements of the temperature regime in the base of the channel showed that by the fourth year of operation of the water engineering system the talik beneath the channel had reached a depth of 30 m. The development of the talik was accompanied by the warming of the thawing ground as the result of the infiltration of water which had been heated to $+20^{\circ}\text{C}$ in the shallow area before the spillway gate. The talik, warmed by the infiltrating water, did not have a change to completely cool off during the winter. During the spring floods the ground temperature in the talik drops to the temperature of the floodwaters and then, as the water is heated up, the temperature rises again.

Once the depth of the talik reached the tailwater level the rate of its downward progress decreased, but it continues to grow in plan since the ice continues to melt in the cracks of the rocks at the edges of the talik, and the annual replacement of the water in the talik prevents its boundaries from stabilizing.

In cases when the water, which forms as the ice melts in the cracks of weathered rocks, can drain away freely, frozen curtains cannot perform the function of watertight elements. In such cases cement grouting of the rock is necessary, with preliminary thawing within the limits of the projected watertight curtain. Grouted curtains alone, however, also cannot completely prevent percolation, as a result of which combination curtains must be created under such conditions. A grouted curtain must be built from the surface down to the level of the tailwater, and a frozen curtain must be created in order to ensure the imperviousness of fissured rock in the zone below the tailwater level.

By using a combination of frozen and grouted curtains it becomes possible to remove the zone of formation of the initial talik to a certain distance from the dam, but prevention of its development is exceedingly difficult. A talik which develops in fissured rock in the spillway channel zone will grow in plan. Its possible development in the direction of the dam is not excluded, which constitutes a particular danger. In such cases it appears to be advisable to consider the construction of spillway structures incorporated into the dam.

Present methods of freezing the ground, and construction experience, make it possible to construct a spillway structure of the frozen type as part of a frozen dam. There had been earlier attempts to construct chute spillways integrated with dams. The initial structures of the temporary Irelyakh water engineering system serve as an example. The experience of building integrated spillways was found to be negative, primarily because of shortcomings in design decisions and poor quality of execution.

CONCLUSIONS

The experience obtained in the construction of water engineering systems in Western Yakutiya makes it possible to establish the main directions to be followed in improving the design, methods, and techniques for building frozen earth dams. Analysis of the experience of building and operating frozen dams makes it possible to draw the following conclusions:

1. Frozen dams can be built on weak ice saturated permafrost if provision is made for the creation of reliable frozen curtains within the supporting mass of the dam which join up with the permafrost of the base;

2. Dam designs may differ, depending on the manner in which the construction work is organized and the way in which the frozen curtain is created. When the frozen curtain is created after the dam profile is built up to the design dimensions a mandatory features of the design is a loam core, with a cutoff which extends into the weak icy earth of the base; the cutoff of the loam core may be omitted as a design element in a dam if the refrigeration system is assembled prior to the start of construction and the frozen curtain is created simultaneously with the erection of the dam.

3. When dam construction work is organized in such a way as to include advance creation of frozen curtains, it appears possible to use local frozen and unfrozen earth for placement in the core, water or grouting mixtures being used to turn the earth into a solid mass. The cores of such dams can be constructed by buildup or dumping into water.

4. It is expedient to use refrigeration equipment with natural circulation of the thermal carrier (thermosiphons) for frozen curtains which are created simultaneously with construction of the dam. The most technologically effective and the simplest to operate are the thermosiphons of the liquid type in which kerosine is the thermal carrier. The use of water soluble thermal carriers is not permitted since they would liquefy frozen earth in the event of a leak.

5. In terms of layout, the spillway structure and the dam are usually located in a zone of mutual thermal interaction, for which reason their design solutions, which determine their temperature regime, must be coordinated, i.e., the spillway structure of a frozen dam must be designed so as to maintain the frozen condition of the earth of the base during the entire period of operation.

This requirement is satisfied, in part, by chute spillways which form an integral part of the dam.

When spillway structures are cut into fissured bedrock it is advisable to construct combined frozen and grout curtains in order to eliminate the possibility of the drainage of water from cracks in thawing rocks.

6. Discharge of water over the crest of unfinished dams during construction makes it possible to drop the construction of expensive temporary spillway structures.

REFERENCES

1. BIYANOV G.F. Dams on permafrost. Moscow, "Energiya" Pub., 184 pages, 1975.

SEASONALLY OPERATING UNITS AND THEIR USE IN NORTHERN CONSTRUCTION

N.A. Buchko

Leningrad Technological Institute of the Refrigeration Industry

A.L. Kuznetsov

Leningrad Planning, Surveying and Research Institute

S.I. Gapeev

Leningrad Planning and Surveying Institute for Transportation Construction

TYPES, DESIGNS, AREAS OF APPLICATION

Three types of seasonally operating cooling units (SOCU) are being studied and used in the Soviet Union; namely air, fluid and vapor units. The greatest amount of experience has been acquired in the operation of forced air SOCU, which are used to freeze the earth in dams of the frozen type. Since 1948 several such dams have been built in the U.S.S.R. They vary in height from 10 to 22 m, and are situated on Lake Dolgoe and the Nalednaya, Irelyakh, Pevek and other rivers.

Air SOCU are installed, after erection of a dam, into holes drilled from the crest. Installation of the systems is also possible prior to construction of the dam body, which obviates the need for drilling operations but results in certain difficulties in the installation of the units and in the placement of the earth (Biyarov, 1975).

Dams of the frozen type are built under differing permafrost geological and climatic conditions using various design parameters for the air cooling systems: distances between individual SOCU in the systems vary from 1.5 to 2.5 m; outer pipe diameters D of 140 to 325 mm, and inner pipe diameters d of 50 to 140 mm are used; the rate of flow of the air may be from 2 to 14 m per second.

The experience of building and operating dams with air cooling systems has been quite extensively described in the literature (Pridorogin, 1970; Biyanov, 1975) and has convincingly proven the technical feasibility and expedience of creating frozen earth curtains with the aid of natural winter cold.

Examples are know of the use of forced air SOCU in industrial and civil construction in order to increase the bearing capacity of soils. In such case the cooling pipes (or special channels) are placed near foundations, within the confines of porous soil embankments. This method was used in the construction of an airport building in the Far North, and for a heated warehouse in the village of Dikson (Velli, 1973; Biyalov, 1975).

Operational experience revealed the following shortcomings in air SOCU:

- 1) a significant change in the air temperature with increasing column depth, which is a result of its low heat capacity;
- 2) the possible blockage of the channels with hoar frost or ice as a result of temperature fluctuations of the humid air;
- 3) a 2 - 3°C increase in the temperature of the air forced into the column within the blower itself;
- 4) the complexity of controls to ensure uniform distribution of air to the columns;
- 5) the need for electric power to operate the blowers, and additional costs involved in their operation;
- 6) the need to build electric power transmission lines when building dams in remote areas.

The first two shortcomings are also characteristic of air SOCU with natural circulation (Reid et al., 1976; Jahn et al., 1973). They may probably be effectively used when the diameter is large and the depth is shallow. H. Jahns studied a system with $D = 460$ mm, $d = 250$ mm, $L = 7.6$ m and $a_{\text{eff}} = 3\text{W/m}^2\text{K}$. Unfortunately, his paper does not explain on what grounds this value for the effective coefficient of heat transfer was chosen.

In contrast to air SOCU, vapor and fluid SOCU are closed devices, consisting of two heat exchangers, in which the refrigerant is circulated by natural means. Both of these types of SOCU are free of the disadvantages inherent in air cooling systems.

Fluid single-pipe, double-pipe and multiple-pipe SOCU, in the arrangement developed by S.I. Gapeev (1969) are used in residential, industrial and transportation construction in order to prevent the degradation of permafrost and to improve the bearing capacity of soils beneath the foundations of buildings, bridge supports and other structures in many regions, including: the Komi ASSR, Yakutsk ASSR, Magadan Oblast and the construction of the Baikal-Amur Railroad.

The operational principle of Gapeev's single-pipe systems is similar to that of closed, single-phase thermosiphons. Heat exchange in such systems has been described in a series of papers (Romanov, 1956; Beili, Loka, 1965; Ivanov, Lapin, 1966; and others). Normal operation of such systems is possible only for a particular L/D ratio. Based on A.G. Romanov's data, the limiting value for this ratio as a function of the system's diameter is 30 for kerosine, ethyl alcohol and freon (for $D = 0.2$ m, $L/D = 20 - 25$; for $D = 0.5$, $L/D = 40 - 50$). For ethylene glycol and potassium hydroxide solutions the above ratios are halved, and potassium hydroxide also corrodes metal pipes.

In double-pipe and multiple-pipe systems of the Gapeev type the fluid circulates faster than in those of the single-pipe type.

The efficiency of double-pipe designs is thus 1.5 - 2 times that of single-pipe designs, while multiple-pipe designs are 2 - 3 times more efficient.

Kerosine is used as the refrigerant in such systems because of its availability and relatively low cost.

Relatively small diameter (100 mm) single-pipe fluid systems with flow guides for dividing the rising and falling flows were studied.

Reinforced concrete piles with such cooling systems incorporated into them are used in residential construction in the City of Mirnyi and have been dubbed "cold" piles (Biyarov et al., 1973).

Research on fluid SOCU of the coaxial type (with exterior heat exchangers having a large surface area) for hydraulic engineering construction was carried out at an installation having a depth of 25 m and with an in ground heat exchanger having a pipe diameter of 169 mm (Biyarov et al., 1973; Molochnikov, Tret'yakov, 1973).

In recent years, theoretical and field studies have been carried out on vapor SOCU, whose principle of operation is similar to that used in Long's thermopiles and the McDonnell Douglas cryo-anchors. Research on the internal processes of vapor SOCU is presented in the work of E.S. Kurylev et al., (1975), while field studies and computational methods are presented in a series of papers (Bychko, 1973; Bychko et al., 1975; Kuznetsov et al., 1976). On the basis of this research a project was developed and approved by the Leningrad Planning and Surveying Scientific Research Institute for the construction of a frozen dam, which is now being built near the city of Anadyr. The curtain in this dam will be created by vapor SOCU having a diameter of 108 mm and a depth of up to 25 m, with exterior heat exchange by way of vaned pipes.

FIELD STUDIES

Data on field studies of air and fluid SOCU have been presented in a series of papers (Gapeev, 1969; Pridorogin, 1970; Velli, 1973; Biyarov, 1975; Biyarov et al., 1975; Biyalov, 1975; and others) and for this reason will not be presented here.

Figure 1

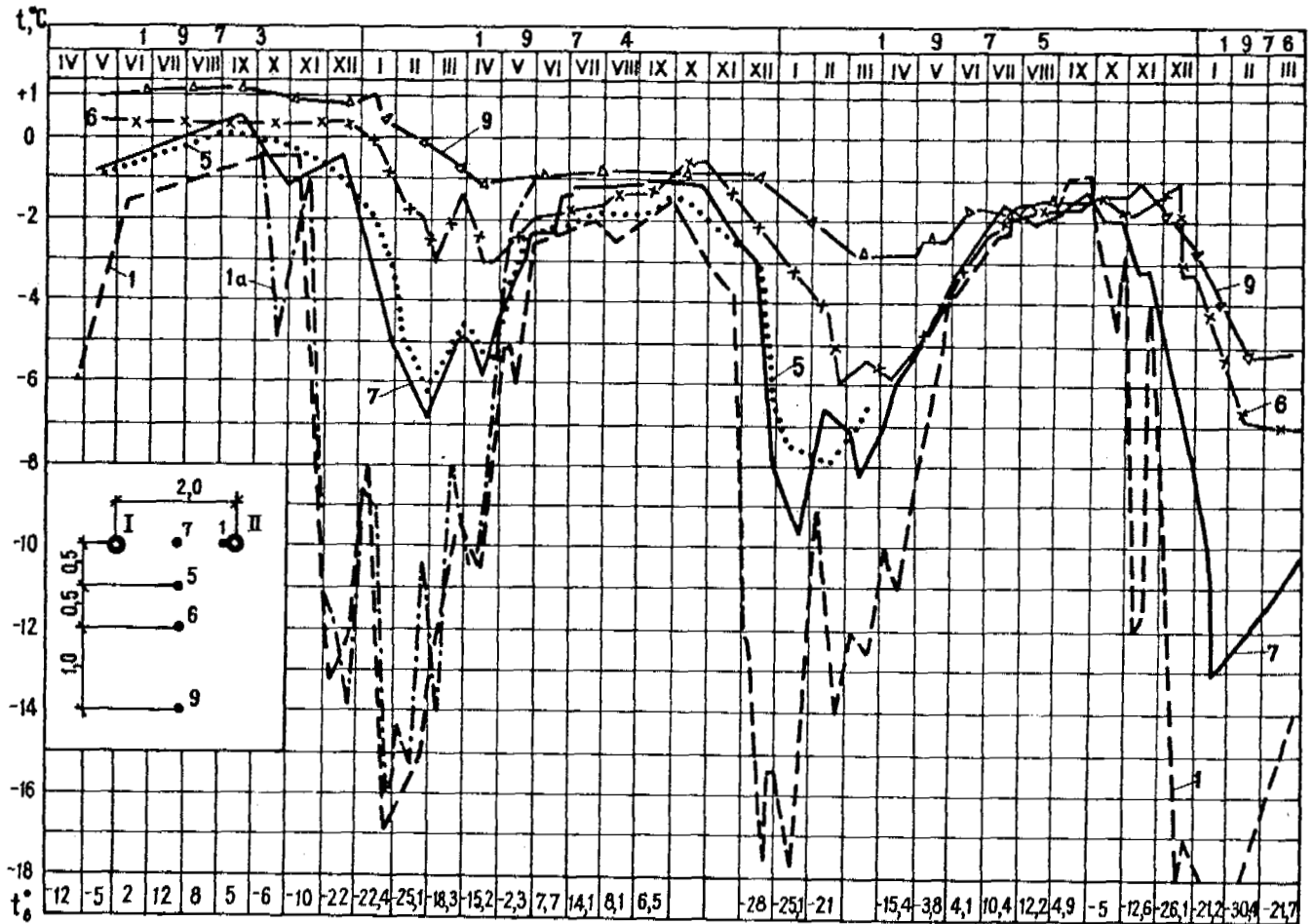

Ground temperature changes in a cross section through 7-9 experimental SOCU

1, 5, 6, 7, 9 - field data from thermal drill holes; 1a - data for thermal drill hole 1 as calculated by computer; I, II - experimental SOCU; t_a - air temperature, °C (numbers of curves correspond to numbers of drill holes).

Beginning in April 1973, field studies have been going on in the U.S.S.R. on freezing of the ground with the aid of experimental vapor SOCU which are located at a lake near the construction site of the dam for the Anadyr heat and electric power plant. Seven SOCU, at intervals of 1.5 to 3 m, were installed in holes drilled in the ice to a depth of 15 m, including 12 m into earth (loam and sandy loam) with a moisture content of 25% and an initial temperature of 3 - 4°C. The diameter of the in ground heat exchanger is 108 mm. Two types of condensers (external heat exchangers) were tested:

varied $F_e/F_{gr} = 2$ and smooth $F_e/F_{gr} = 1$. The refrigerant is freon-12. During the first period of freezing, April-May 1973, (average air temperature of -12°C) the ground was cooled to $0 - 2^{\circ}\text{C}$ in a zone 4 m wide along the cooling system; between the SOCU which were 1.5 m apart the ground froze. In the winter of 1973-1975 the ground froze between all of the SOCU and the thickness of the resulting permafrost wall was approximately 4 m. In subsequent years the thickness of this wall increased and the mean temperature of the frozen zone dropped from year to year. For example, in October of 1974 the temperature of the earth at a distance of 2 m from the system's axis was approximately -1°C , while in October 1975 it had dropped to -1.5°C (see Figure 1).

In winter, despite intense heat exchange with water, the isotherms in the earth within the zone of action of the cooling systems are almost vertical (Figure 2), which confirms theoretical ideas about the isothermal nature of the evaporator (in ground heat exchanger). It is noted that in winter air temperature fluctuations with a period longer than 24 hours significantly affect the temperature of the evaporator and of the earth to a distance of up to 1 m from the SOCU. During their three years of operation all of the experimental units worked reliably, and loss of freon was not detected.

COMPUTATIONAL METHOD

An approximate unified method of calculations has now been developed for vapor, single-pipe and coaxial fluid, and air SOCU. The main aspects of the method are presented below.

Heat calculations for SOCU are understood to mean the solution of problems of thermal interactions within the "earth-SOCU-atmosphere" system. The desired quantity is the temperature field in the earth cooled by a single cooling unit or by a cooling system. The following input data are required: climatic data for the construction region, thermophysical parameters and moisture content of the soil, and SOCU design data (pipe diameters, heat exchanger dimensions). A solution is obtained to the problem of variable thermal conductivity within an earth massif cooled by means of the

Figure 2

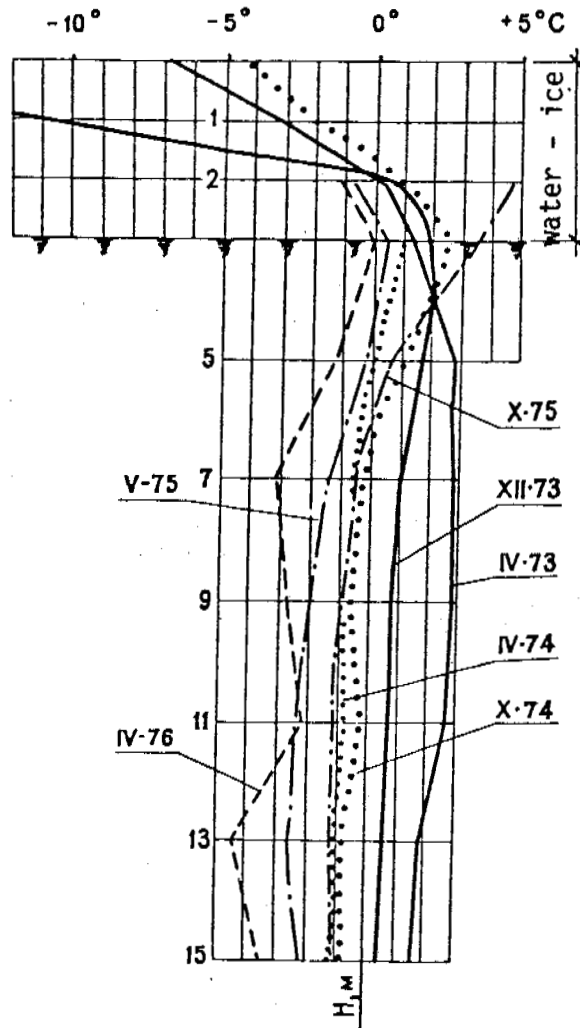

Vertical distribution of ground temperatures in drill hole 9.

cylindrical voids, at whose boundaries order III conditions prevail. Under these circumstances the outside air acts as the cooling medium, while the coefficient of heat transfer is the effective coefficient determined by the relation

$$a_{\text{eff}} = \frac{1}{1/a_{\text{gr}} + \Delta t_h/q_{\text{gr}} + F_{\text{gr}}/a_r F_i + F_{\text{gr}}/a_e F_e} \quad (1)$$

where a_{gr} , a_r , a_e - are the coefficients of heat transfer from the ground to the refrigerant, from the refrigerant to the wall of the external heat

exchanger, and from the wall of the external heat exchanger to the air, respectively; F_{gr} , F_i , F_e - are the surface areas of the in ground heat exchanger, the inner surface of the external heat exchanger, and the outer surface of the external heat exchanger respectively; Δt_h - is the difference between the temperature of the refrigerant in the ground heat exchangers and in the external heat exchangers.

In order to arrive at a solution, the values a_{gr} , a_r , a_e and Δt_h are represented by well known relations as functions of the density of heat flow from the earth, taking the type of SOCU into account (since air SOCU have no external heat exchanger, for them $F_e = F_i = \infty$). Difficulties arise only with fluid SOCU of coaxial design because of inadequate knowledge of the internal processes of heat exchange and hydrodynamics, but the problem can be solved in a first approximation (Buchko et al. 1976). In order to solve the problem of variable thermal conductivity in freezing ground it is possible to use algorithms, as described by N.A. Buchko (1975), N. Shamsundar and E.M. Sierou (1976). Adjustment of the a_{eff} value can be incorporated in the programs on the basis of the corresponding q_{gr} value for each increment of time. In order to test the reliability of this computational method, field data were compared with calculated values (Figure 1, hole 1), and a satisfactory match was obtained. However, as shown by the calculations, in the interval of change in heat flow from the ground $q_{gr} = 25 - 200 \text{ W/m}$, which is possible in practice, it may be assumed that

$$a_{eff} = \text{constant}$$

with an accuracy of 18% for vapor SOCU and 20% for fluid SOCU. The numerical value of a_{eff} can be calculated with the aid of equation (1), before solving the main problem of thermal conductivity, as the mean in the given interval q_{gr} .

In the case of air SOCU a_{eff} does not depend at all on q_{gr} and can be calculated on the basis of the initial data.

The assumption about the constant nature of a_{eff} not only simplifies the algorithm but also makes it possible to generalize the results

of mathematical modelling by the method of similitude in the form usually taken for problems of transient heat flow.

By generalizing the calculations, equations were obtained for the dam on the basis of which the following desired values could be determined: the dimensions of the frozen earth wall created by the SOCU system during the winter, the quantity of heat transferred, and the time required for the frozen earth cylinders to join up. The equation is as follows:

$$X = C B_i^{m_1} \left(\frac{F_0}{K_0}\right)^{m_2} \left(\frac{1}{R}\right)^{m_3} Q^{m_4} Q_{gr}^{m_5} \quad (2)$$

where X - is the desired dimensionless value;

$$B_i = \frac{a_{eff} r_{he}}{\lambda_M}; \frac{F_0}{R_0} = \frac{\lambda_M |\bar{t}_a| \tau_{year}}{\phi R^2}; Q_0 = \left| \frac{A_a}{\bar{t}_a} \right|; Q_{gr} = \left| \frac{t_{gr}}{\bar{t}_a} \right|;$$

R - is a characteristic size (R = 3 m);

r_{he} - is the radius of the in ground heat exchanger;

l - is the distance between SOCU;

ϕ - is the heat of phase transition per 1 m³ of earth;

t_a, A_a - are the mean annual temperature and the amplitude of fluctuations in air temperature;

τ_{year} - length of year;

λ_M - is the coefficient of thermal conductivity of the earth;

t_{gr} - is the initial temperature of the ground ($t_{gr} \geq 0^\circ\text{C}$).

The numerical values of the factor C and of the exponents $m_1 m_2 \dots m_5$ correspond to each of the desired values X_i .

COMPARISON OF THE EFFECTIVENESS AND SELECTION OF THE MOST SUITABLE SOCU DESIGN

In order to obtain an equal cooling effect from various types of systems it is sufficient that their coefficients of heat transfer be the same.

For vapor SOCU the a_{eff} is determined mainly by the size of the coefficient of heat transfer to the outside air a_e and the ratio F_e/F_{gr} ,

inasmuch as the coefficients of internal heat exchange are immeasurably greater than a_e , while the value Δt_h is negligibly small (Kurylev et al., 1975).

For fluid SOCU of all designs the coefficients of internal heat transfer are commensurable with a_e , while the value of Δt_h is as high as 4°C . In this case the effective coefficient of heat transfer is 1.5 - 2 times smaller than the a_{eff} of vapor SOCU with similar design parameters. ($D, L, F_e/F_{\text{gr}}$).

The effective coefficient of heat transfer of air SOCU, when the air flow rate is constant, is inversely proportional to their depth, diameter and coefficient of heat transfer through the inner pipe. The latter indicates that the use of thermal insulation on the inner pipe of air SOCU is highly advisable. For a constant air flow rate (transient load), the efficiency of air SOCU improves as the diameter is increased. As a result of low heat capacity, the value of Δt_h in air columns is approximately one order of magnitude higher than in fluid SOCU.

It is possible to improve the efficiency of vapor and fluid SOCU by increasing the surface area of the external heat exchanger, but two things must be considered if this is done.

Firstly, it is inexpedient to make the external heat exchanger too large since the cost involved may not be recovered by the increase in efficiency. This is graphically illustrated in Figure 3, which shows the maximum radius of the cylinder of frozen earth which forms around one SOCU in one winter as a function of the complex of variables $a_{\text{eff}}F_e/L$. It follows from the Figure that when $a_{\text{eff}}F_e/L > 12$ the increase in R_3 when F_n increases is insignificant. Physically this means that for high $a_{\text{eff}}F_e/L$ the limiting thermal resistance to heat transfer becomes the thermal resistance of the earth. Under these circumstances it is possible to improve the efficiency of SOCU by increasing the surface area not of the external but rather of the in ground heat exchanger.

Secondly, with an increase in F_e there is a more significant increase in the efficiency of vapor SOCU, since in their case this does not

Figure 3

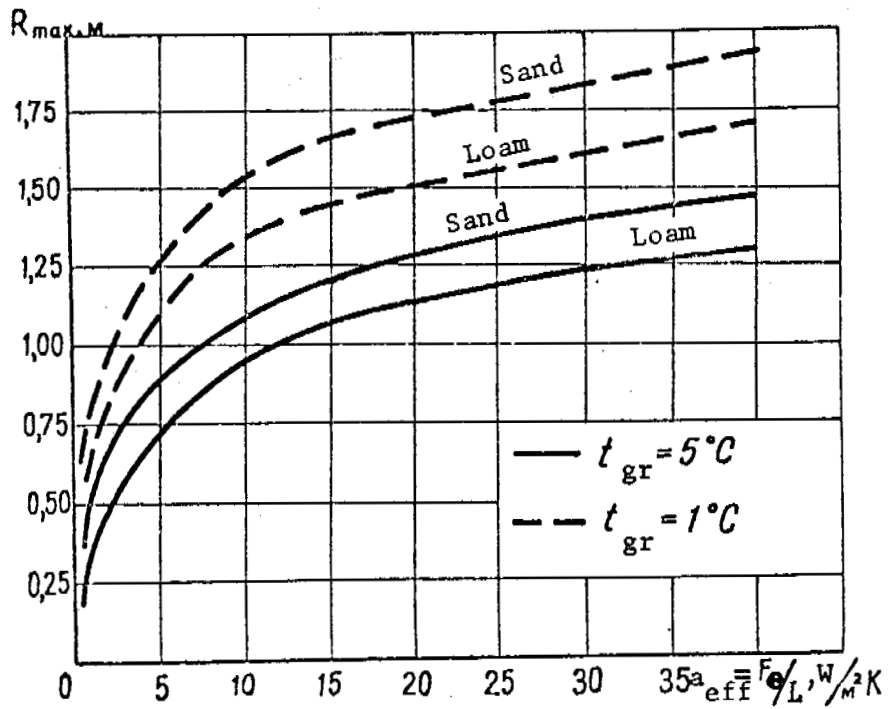

Radius of the cylinder of frozen earth which forms in one winter around a single SOCU depending on the $a_{eff} F_e / F_{gr}$.

result in an appreciable change in the role of the internal heat exchanger, while for fluid SOCU there is a noticeable decrease in a_r with increasing F_e and F_i .

Figure 4

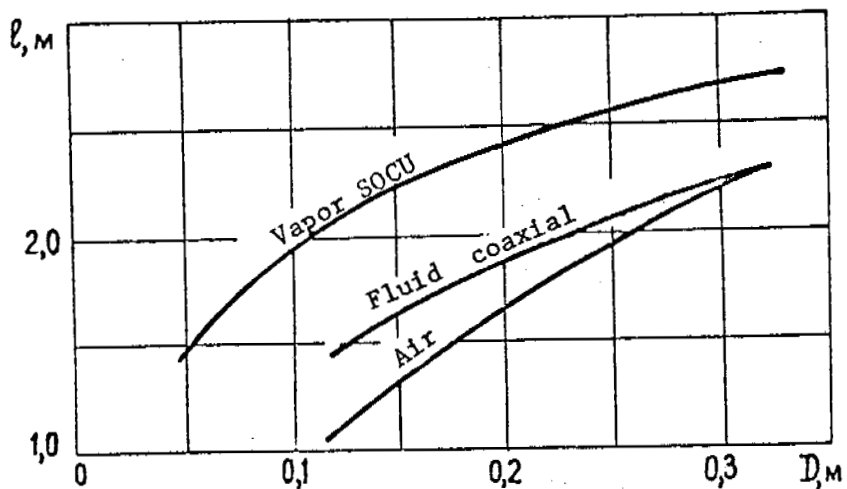

The effectiveness of various types of SOCU.

Thus, for a particular SOCU (or SOCU system) type and design, by using the method described above it is possible to establish the ground cooling effect achieved and the cooling cost which, in the final analysis, is the most important criterion for the suitability of a chosen cooling method. Such calculations were carried out in order to select the type and design of the cooling system intended to create the cutoff curtain of the Anadyr dam. Figure 4 shows curves of the permissible distance between SOCU in a system as a function of their diameter and type. These data and the corresponding financial calculations were the basis on which the engineering decision was made.

CONCLUSIONS

The field and theoretical research data on the seasonally operating types of cooling installations which were examined provide a clear idea of their mechanism of operation. This has made it possible to develop an approximate unified method of thermal calculations for vapor, single-pipe coaxial fluid, and air SOCU. This permits quantitative evaluation of the effectiveness of specific designs, and also financial comparison of various types.

Cost accounting of frozen-earth cutoff curtains created with the aid of vapor, coaxial fluid, and air SOCU has shown that the cheapest of the examined methods is the vapor SOCU.

Fluid and vapor SOCU can be used in structures intended for various purposes in order to raise the bearing capacity of the soil and to create cutoff curtains.

Fluid and multiple-pipe SOCU are more efficient than double-pipe units and make it possible to freeze the ground at deeper levels.

Fluid single-pipe SOCU are adequately effective at shallow depths.

Forced air SOCU are the least effective and their use requires specific justification.

REFERENCES

- BEILI F.I. and LOKK Zh.S. Thermal characteristics of a closed thermosiphon. Teploperedacha, Series "C", No. 1, pp. 36-48, 1965.
- BIYANOV G.F., MAKAROV V.I. and MOLOCHNIKOV A.D. Fluid cooling installations for freezing thawed and cooling plastic frozen earth during construction in regions with a severe climate. II International Permafrost Conference. Reports and Communications, No. 7, Yakutsk, pp. 195-199, 1973.
- BUCHKO N.A. An algorithm for the numerical solution of Stefan's two-dimensional problem by the enthalpy method for a triple-layered explicit scheme. Kholodil'naya i kriogennaya tekhnika i tekhnologiya, Moscow, pp. 142-154, 1975.
- BUCHKO N.A., KUZNETSOV A.L., SOKOLOV V.S. and TSOKURENKO K.M. The use of thermal piles for the creation of frozen cutoff curtains. Gidrotekhnicheskoe stroitel'stvo, No. 5, pp. 26-30, 1975.
- BUCHKO N.A., LEBEDKINA I.K. and ZELENOVA N.Yu. An approximate unified method for calculating and comparing the efficiency of vapor and fluid thermal piles. Kholodil'naya tekhnika, No. 3, pp. 25-29, 1976.
- VELLI Yu.Ya. The stability of buildings and structures in the Arctic. Leningrad, Stroizdat Pub., 152 pages, 1973.
- VYALOV S.S. Principles of the control of geocryological conditions during construction in areas of permafrost. II International Permafrost Conference, No. 8, Yakutsk, pp. 151-188, 1975.
- GAPEEV S.I. Stabilization of permafrost foundations by cooling. Leningrad, Stroizdat Pub., 104 pages, 1969.
- IVANOV V.L. and LAPIN Yu.D. Calculation of thermal resistance in a closed thermosiphon. Bulletin of the Higher Educational Institutions, Energetika, No. 10, pp. 112-116, 1966.
- KUZNETSOV A.L., TSOKURENKO K.M. and BUCHKO N.A. Results of field studies of experimental thermal piles for the dam of the Anadyr heat and electric power plant. Collected papers of the All-Union Planning, Surveying, and Scientific Research Institute, No. 51, Moscow, pp. 110-115, 1976.
- KURYLEV E.S., ONOSOVSKII V.V. and SOKOLOV V.S. Comparative analysis of the internal processes in thermal piles. Kholodil'naya tekhnika, No. 6, pp. 37-41, 1974.
- KURYLEV E.S., ONOSOVSKII V.V. et al., The role of internal processes in thermal piles. Kholodil'naya i kriogennaya tekhnika i tekhnologiya, pp. 155-175, 1975.

- MOLOCHNIKOV A.D. and TRET'YAKOVA G.V. The results of field studies of installations with natural circulation of a fluid refrigerant for freezing earth in hydraulic engineering construction. In the book: Problems of northern construction. Krasnoyarsk, No. 2, pp. 44-48, 1973.
- MOLOCHNIKOV A.D. and TRET'YAKOVA G.V. The use of refrigerator piles in construction. Ibid., pp. 49-55, 1973.
- PRIDOROGON V.M. Proposals for the design of an air cooling installation. Proceedings of the VI Conference-Seminar for the Exchange of Knowhow on Construction Under Severe Climatic Conditions. Vol. VIII, No. 1, Krasnoyarsk, pp. 116-120, 1970.
- REID R.L., TENNENT D.S. and CHILDS K.V. Modelling of a thermosiphon installation for the preservation of permafrost. Teploperedacha Series "C", Vol. 97, No. 3, pp. 68-73, 1976.
- ROMANOV A.G. Investigation of heat transfer in a blind channel under conditions of natural convection. Bulletin of the Academy of Sciences U.S.S.R., Department of Technical Sciences, No. 6, pp. 63-76, 1956.
- SHAMSUNDAR N. and SIERROU E.M. Using the enthalpy method in the analysis of the multi-dimensional problem of thermal conductivity in the presence of a phase transition. Teploperedacha, Series "C", Vol. 97, No. 3, pp. 14-23, 1976.
- JAHNS H.O., MILLER T.W., POWER L.D., RICKEY W.P., TAYLOR T.P. and WHEEBR, J.A. Permafrost protection for pipelines. Permafrost, II International Conference, Washington, D.C. NAS, pp. 673-683, 1973.
- BIYANOV G.F. Dams on permafrost. Moscow, Energiya, 184 pages, 1975.

CONSTRUCTION OF MULTI-STOREY BUILDINGS ON COLD PILES
IN THE CITY OF MIRNYI

V.I. Makarov, A.A. Plotnikov and B.F. Chumaevskii

Permafrost Institute, Yakutsk

Moscow Construction Engineering Institute

Yakut Research and Planning Institute of the Diamond Mining Industry

The city of Mirnyi is situated in Western Yakutiya in the zone of widespread permafrost. Despite the low mean annual temperature of -7.6°C , in individual parts of the city high temperature permafrost and even water saturated taliks occur. The extensive construction of multi-storey buildings on these sites was facilitated in great measure by the use of self-cooling piles which can effectively lower the temperature of the soil in the base during the periods of construction and operation. These piles differ from the usual ones by the presence of an individual fluid coaxial heat exchanger built into each pile. The piles with built-in cooling equipment which were used in Mirnyi acquired the name "cold" piles. The design of a cold pile is shown schematically in Figure 1a.

Fluid coaxial thermosiphons, with an outer diameter of 80 to 100 mm, are located inside reinforced concrete piles with a 0.3×0.4 m cross section. This design was made possible by the structural features of the thermosiphon, which was developed to allow the required rate of heat exchange in winter without increasing the surface area of the above ground part of the system and eliminating the possibility of circulation of the refrigerant when the difference between the temperature of the atmospheric air and the ground is positive. This latter feature eliminates the danger of the loss of bearing capacity by a cold pile when there is a brief reverse heating circulation of the refrigerant.

Figure 1

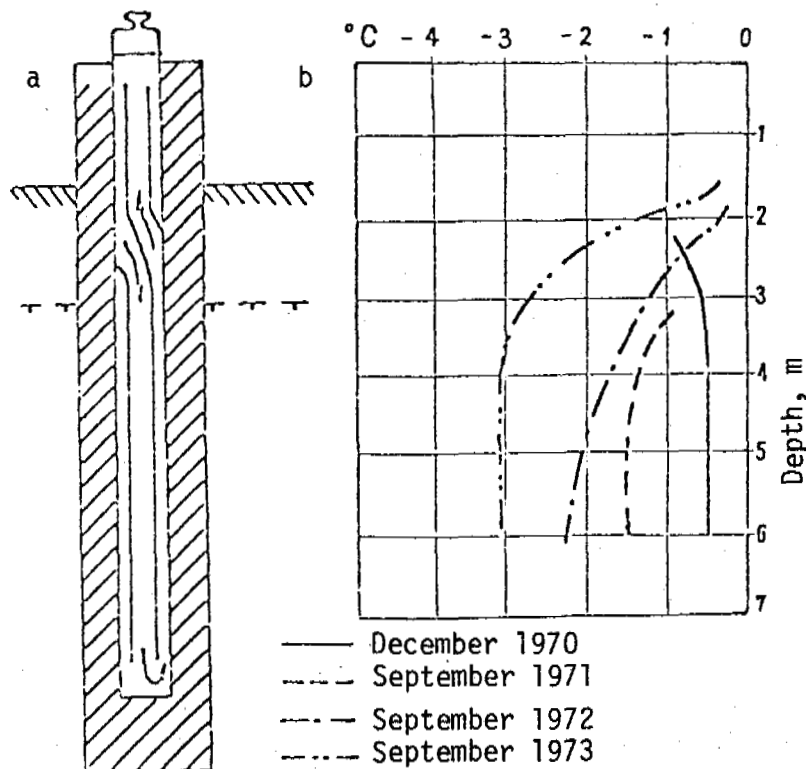

Cooling of bases with the aid of cold piles
a - schematic cross section of a pile;
b - maximum soil temperatures in the base of a nine storey building with a high open cellar and cold piles on a site with high temperature permafrost.

Location of the thermosiphon within the pile makes for rapid cooling of the soil around it, improves the reliability and durability of the system, and eliminates the need to drill additional holes.

The design of a cold pile was worked out as the result of field studies carried out by the Yakut Research and Planning Institute of the Diamond Mining Industry (Makarov, 1970). Cold piles have been recommended since 1968 for use in the construction of buildings on high temperature permafrost. In 1969 construction of the first nine-storey building on cold piles was begun in the city of Mirnyi. Figure 1b shows the results of observations in the form of graphs (Molochnikov, Tret'yakova, 1973) of the distribution of temperature with depth in the base of this building during characteristic periods when the average temperature, in terms of depth of the

frozen pile section, has the highest value. Despite the fact that the thermosiphons inside the piles were charged with refrigerant only toward the end of February 1971, the temperature of the soil dropped by more than one degree by the end of the summer. In subsequent years the maximum negative temperatures of the soil in the base of the building dropped at different rates, depending on the characteristics of the climate for that particular year.

By 1976 more than twenty multi-storey buildings on cold piles were built on high temperature permafrost in Mirnyi. By lowering the working temperature of the permafrost the depth to which piles had to be driven into the permafrost and their total number beneath each building were significantly reduced, which made it possible to significantly lower the cost of foundations while increasing their reliability.

In recent years cold piles have been used in Mirnyi in the construction of buildings not only on high temperature permafrost but also on sites previously considered to be unsuitable for construction due to non-freezing taliks. Construction of the first building (four-storey residential building No. 69) to be built on cold piles driven into unfrozen soil was begun in January 1972. Eight metre long piles were driven to a depth of 6.5 m into talik approximately 12 m deep. In this case the six metre long fluid thermosiphons were found to be at a depth of 4.5 m in the foundation.

The site geomology is characterized by the column shown in Figure 2.

The thermosiphons were charged with refrigerant at the end of February. After the first incomplete cooling cycle the soil in the base of the building was frozen, but the temperature of the frozen massif by the fall of 1973 was found to be insufficiently low to ensure the design bearing capacity of the piles. In the summer of 1973, after erection of two stories, construction of the building was halted. In the winter of 1973 construction of the building was completed and it was brought into service by the fall of 1974. The temperature field in the base of the building toward the end of the summer of 1974 is shown in Figure 2.

Figure 2

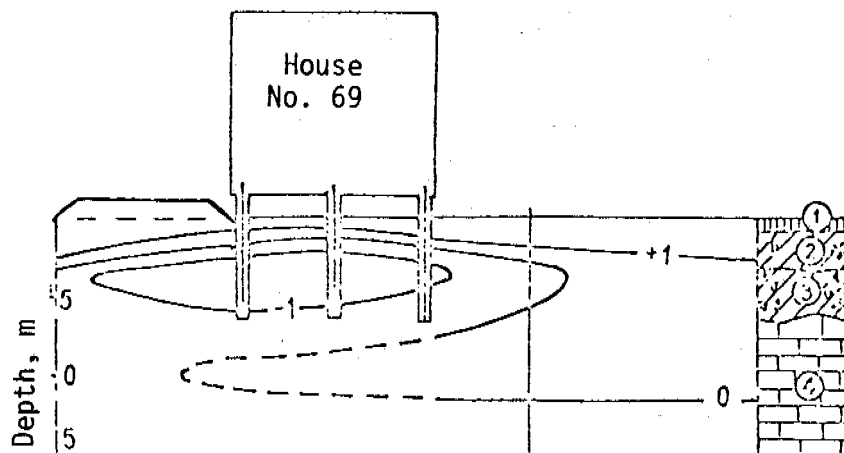

Temperature field in the base of four-storey building No. 69, built on CX-8/6 cold piles, as of September 1974.

- 1 - dumped soil (sandy loam with up to 40% gravel);
- 2 - sandy loam with up to 30% and grus;
- 3 - grus gravel soil with sandy loam up to 30-40%;
- 4 - weathered highly fractured marl.

The slight assymetry of the temperature field beneath the building is explained by the fact that an embankment for crane traffic was constructed on the left side of the building. This helped maintain negative temperatures in the base.

In 1975 two more buildings (house No. 68 and No. 74) were built on the same site. Taking into account the experience gained in the construction of house No. 69, the length of the fluid thermosiphons built into the eight metre long piles was increased to 8 m, which made it possible to obtain design temperatures for the soil after the very first cooling cycle, thus ensuring the design bearing capacity of the piles. The temperature field in the base of the group of buildings by the end of the summer of 1976 is shown in Figure 3.

Observations revealed that a lens of frozen soil forms in the bases of buildings built on cold piles driven into unfrozen soil. Beneath a group of buildings built on a site with deep seated taliks a layer of frozen soil at adequately low temperatures forms quite quickly. As this occurs there is a significant decrease in the depth of seasonal thaw, especially under buildings, where it is barely half as much as on an open site.

Figure 3

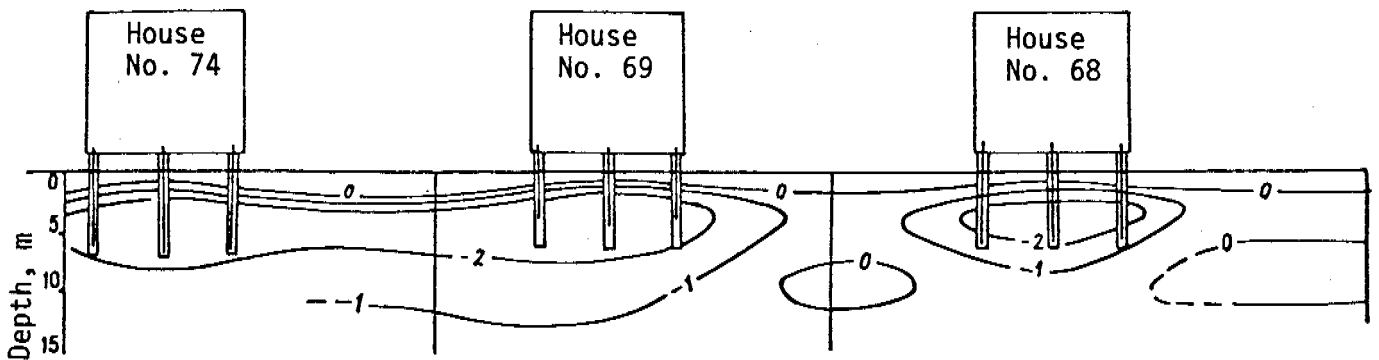

Temperature field in the base of a group of buildings built on cold piles driven into unfrozen soil. Measurements taken in September 1976.

Construction on cold piles has shown the practical feasibility of erecting buildings on foundations of a single engineering design type regardless of the initial temperature regime of the soil, which is of great importance in large scale rapid construction.

The positive experience of erecting buildings in compliance with the first principle* on sites with deep seated taliks not only broadens the area of application of this principle of construction in regions of widespread permafrost but also shows the theoretical possibility of construction using artificial freezing of the soil in regions of severe climate but lying beyond the boundaries of the permafrost zone.

The experience of using cold piles in the city of Mirnyi is of a regional nature and thus cannot be mechanically applied in regions with different natural and climatic conditions.

With the aim of generalizing the results obtained, further research on the principles of formation of the temperature regime of the cooled soil is being carried out with the aid of numerical modelling methods and using a computer. The solution to the problem is tied into calculation of the temperature fields in the soil base and determination of the bearing

* Design of the foundations of buildings in the U.S.S.R. is carried out in accordance with two principles governing the use of frozen soil in bases. Principle I states that the frozen soil in the base be used in the frozen state, which is maintained during construction and throughout the service life of the building or structure. (Transl.).

capacity of the piles which are frozen into the soil. The calculations are based on a physical model which represents a soil mass consisting of elementary blocks (see Figure 6). Heat exchange between blocks is described by an equation of conductive heat exchange with internal sources of heat q_{xc} , which thermosiphons in cold piles in fact are. In the enthalpy form this equation (Buchko, 1975) is written as follows

$$\frac{\partial H}{\partial \tau} = \text{div} (\lambda \text{ grad } T) + q_{xc} \quad (1)$$
$$\partial H = C_{\partial \Phi} (T) \partial T$$

where H - specific enthalpy;

$C_{\partial \Phi}$ - effective heat capacity, taking into account both the heat capacity of the soil itself and the heat of phase transitions of ground moisture;

T - temperature;

τ - time;

λ - coefficient of thermal conductivity of the soil.

For practical calculations the dependence of soil enthalpy on temperature must be established. With this aim, the concept of soil enthalpy within the range of practically feasible temperatures from -50 to 50°C is introduced. The heat capacity of soil at a temperature of -50°C is arbitrarily set at zero. The range of temperatures is subdivided into three sections whose change in enthalpy and $C_{\partial \Phi}$ are shown in Figure 4.

The first section is the region of positive temperatures from $+50^{\circ}\text{C}$ to 0°C , where the heat capacity of unfrozen ground C_T is constant.

$$H' = C_T T$$

Phase transitions of free moisture take place in the second section from 0 to -0.3°C and below. Assuming that the temperature which corresponds to the onset of freezing of the bound moisture is $T = -0.3^{\circ}\text{C}$, the limits of this section are set at from 0 to -0.3°C .

$$H'' = \sigma\gamma(W_C - W_p) + C \cdot T$$

where σ - specific heat of fusion of ice;
 γ - volume weight of the permafrost skeleton;
 W_C - total ground moisture;
 W_p - moisture content at rolling boundary.

Figure 4

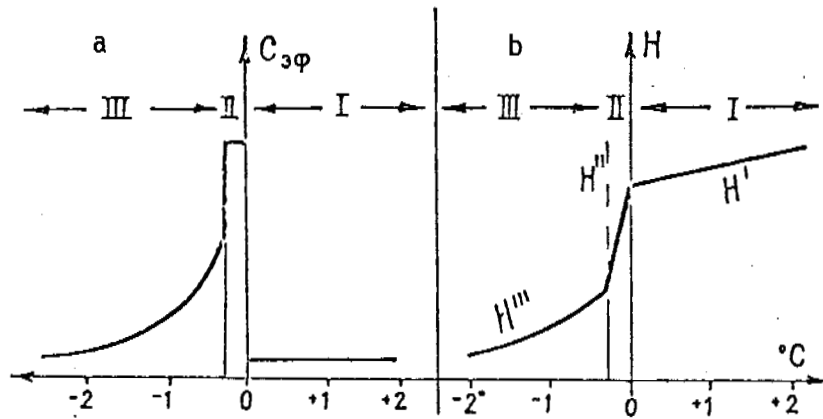

Thermophysical characteristics of argillaceous soil.
 a - change in the effective heat capacity of soil within the range -2 to $+2^{\circ}\text{C}$;
 b - as in a, for an arbitrary soil enthalpy.

In the third section, in the range of temperatures between -0.3 and -50°C , the enthalpy is determined by the heat capacity of the frozen soil and the heat of phase transitions of the bound moisture.

$$H''' = \int_{-0.3^{\circ}\text{C}}^{-50^{\circ}\text{C}} C_{\ominus\phi}(T) dT = \int_{-0.3^{\circ}\text{C}}^{-50^{\circ}\text{C}} [C_M(T) + \gamma\sigma \frac{\partial W_H}{\partial T}] dT$$

where C_M - volume heat capacity of frozen soil;
 W_H - unfrozen moisture in parts per unit.

The actual values of the arbitrary enthalpy for each type of soil are determined on the basis of engineering and geological research data.

The boundary conditions at the surface of the massif beneath a building are established by taking into account the cooling effect of the open air space, where, in view of the absence of snow in winter and the shading of the surface in summer, field studies carried out in Mirnyi by the Moscow Construction Engineering Institute have shown that it is permissible to take into account only the convection component of heat exchange. The coefficient of heat exchange is assumed to be constant throughout the year, while the air thermogram is specified as being sinusoidal.

Outside of the zone of the building the boundary condition is established as a sinusoidal thermogram immediately at the surface of the ground, the mean annual temperature taken to be equal to the temperature in the zone of annual null amplitudes, taking into account temperature displacement as determined by preliminary calculations (Kudryavtsev et al., 1974). Compaction of the snow beneath thoroughfares, walkways, play areas, etc., results in decreased soil temperatures, which are not taken into account in calculations.

The entire massif is in the form of heterogeneous horizontal soil layers whose thermophysical characteristics are determined depending on the temperature of the layer and the depth at which it occurs. The lateral surfaces of the massif are assumed to have heat flows equal to zero. The lower boundary of the massif is assumed to be at a constant temperature.

The boundary conditions at the surface of the cooling elements (cold piles) are assumed to conform with those established on the basis of field and laboratory experiments carried out by the Yakut Research and Planning Institute of the Diamond Mining Industry.

It was experimentally established that the temperature of the fluid within the thermosiphon circuit depends on the temperature of atmospheric air T_a , the geometric parameter of the thermosiphon π , the initial mean integral temperature of the enclosing soil T_P , and the conditions of heat transfer in the above ground portion of the thermosiphon, which are taken into account by the coefficient ϕ which characterizes the effectiveness of the thermosiphon. The general formula for determining the temperature of the refrigerant has the following form:

$$T_{\text{ж}} = \phi \cdot \pi \cdot T_{\text{a}} + T_{\Gamma} \quad (2)$$

A characteristic feature of the processes of heat exchange in a fluid thermosiphon is that the temperature of the refrigerant is independent of the nature of the thermal processes in the enclosing soil, i.e., the principles of change of the temperature of the fluid within the thermosiphon circuit are practically identical and do not depend on whether unfrozen soil is being frozen or frozen soil is being further cooled.

If we take the value of the coefficient of heat transfer to be that which is given for the above ground portion, then in accordance with (2), changes in the fluid temperature will be determined only by the nature of the change in the temperature of the atmospheric air, as per the scheme in Figure 3.

The period of negative air temperatures can be arbitrarily divided into three stages. During the first stage the temperature of the air drops from zero to its maximum values. At this time the temperature of the fluid also begins to drop from the moment that the air temperature becomes lower than the average soil temperature T_{Γ} longitudinally along the underground part of the thermosiphon.

During the second stage the temperature of the atmospheric air rises from the minimum values up to the temperature of the fluid. The instant that these temperatures equalize marks the end of the second stage. The temperature of the fluid during this stage stays close to the constant temperature which it had at the end of the first stage. During the third stage the temperature of the atmospheric air increases to zero degrees. The temperature of the fluid during this period is below the temperature of the atmospheric air, for which reason the circulation of the refrigerant in the thermosiphon ceases.

The heat flow Q_a from the fluid to the atmospheric air in the above ground part of the thermosiphon is determined with the aid of the well known expression:

$$Q_a = k \cdot f_a \cdot (T_a - T_{\text{ж}}) \quad (3)$$

where k - is the coefficient of heat transfer for the above ground part of the thermosiphon, whose value is determined with the aid of working formulas obtained experimentally for different conditions;
 f_a - is the surface area of the above ground part of the thermosiphon.

The nature of the change in the temperature difference which is proportional to the magnitude of the heat flow is shown in Figure 5, from which it may be seen that cooling of the ground occurs only during the first and second stages.

Figure 5

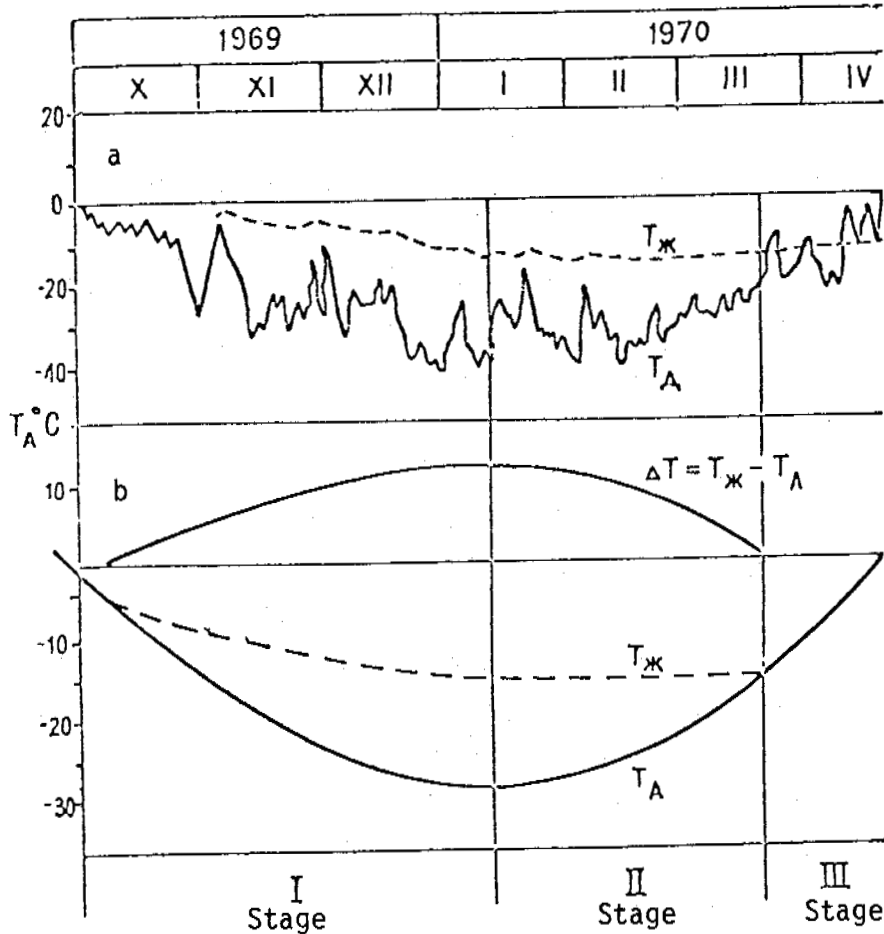

Nature of the change in fluid temperature as a function of the temperature of atmospheric air with time.

a - results of field experiments;
 b - scheme used in calculations.

Field experiments at sites with a 4 to 26 m depth of the underground portion showed that the density of the heat flow at the wall of the outer pipe of the underground part of the thermosiphon is almost constant with depth. This makes it possible to determine the average density of the heat flow for the underground portion of the thermosiphon if the magnitude of the heat flow in the above ground portion is known.

Thus, the surface of the cooling elements determines the second order boundary conditions, the algorithm for determining which is expressed as follows:

1. Determination of the reference point in the annual cycle.
Conditions for the stages:

Stage IV (summer) $T_a > 0; Q_a = 0;$

Stage I $T_a < 0; (\text{grad } T_a) < 0; Q_a \geq 0;$

Stage II $T_a < 0; (\text{grad } T_a) \geq 0; T_a < T_{\text{ж}} \cdot Q > 0;$

Stage III $T_a < 0; T_a > T_{\text{ж}}; Q_a = 0.$

2. Determination of the average soil temperature T_{Γ} for the underground portion of the thermosiphon h_0 .

3. Verification of the condition for the first stage only, if $\bar{T}_{\Gamma} < T_a; Q_a = 0$, otherwise $Q_a > 0$.

4. Determination of the temperature of the refrigerant $T_{\text{ж}}$ using formula (2).

5. Determination of the heat flow using formula (3).

6. Determination of the design length of the underground part of the thermosiphon. The upper layer of soil h_{Γ} whose temperature is below the temperature of the fluid is excluded from the calculations.

7. Determination of the linear density of the heat flow

$$q_e = Q_a / (h_o - h_T)$$

The problem is solved by the method of finite differences with approximation of equation (1) as per the explicit scheme:

$$\frac{H_i^{k+1} - H_i^k}{\Delta\tau} = \lambda(T) \frac{T_{i+1}^k - 2T_i^k + T_{i-1}^k}{h^2} + q_{xc} \quad (4)$$

For a multivariate problem the equation is transformed into the form

$$H_0^{k+1} - H_0^k = \sum_1^n A_n \cdot T_n^k - T_0^k \sum_1^n A_n + q_{xc} \cdot \Delta\tau, \quad (5)$$

where $A_n = \Delta\tau/h_n \cdot R_n$.

In equations (4) and (5) the lower indices designate spatial coordinates while the upper indices indicate the time intervals:

- $\Delta\tau$ - is the size of the interval in time;
- h - is the size of the interval in space;
- R - is the given thermal resistance between adjacent blocks.

Taking into account that equation (5) determines the heat exchange in a single block, the heat absorption provided by a cold pile q_{xc} must also be related to a single volume

$$q_{xc} \Delta\tau = q_e \cdot \Delta\tau \cdot h/v, \quad (6)$$

where v - is the volume of an elementary block. In this case the value of $q_{xc} \cdot \Delta\tau \neq 0$, only in those blocks in which cold piles are located.

The program for solving this problem is written in FORTRAN-IV and run on a "MINSK-32" computer. The relation of the intervals in space and

time were chosen on the basis of the usual condition of stability for an explicit scheme. Numerous computational variants, using various combinations of intervals in time and space in accordance with the assumed conditions, revealed no loss in the stability of the chosen scheme.

As an example, Figure 6 shows the result of a solution to the problem with conditions corresponding to the actual conditions for house No. 68, whose actual temperature field in the base is shown in Figure 3.

Figure 6

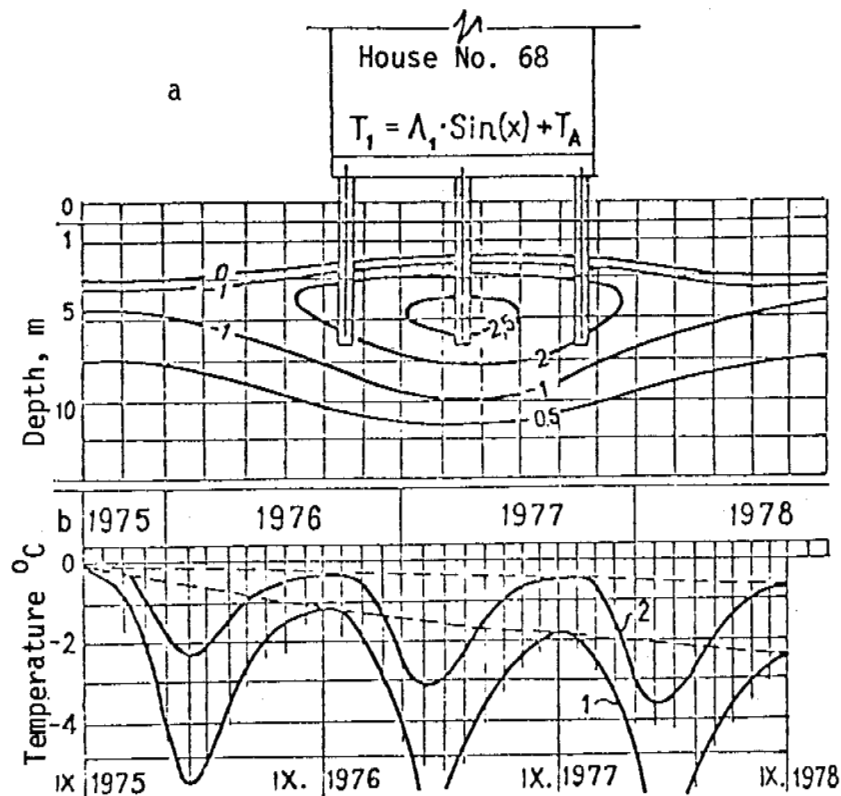

Results of computer calculations.

- a - temperature field in the base of building No. 68 for September 1976;
- b - change in soil temperature with time (mean arithmetic value of frozen soil temperatures longitudinally along the end pile).
- 1 - joint effect of cold piles and cellar;
- 2 - effect of cellar alone.

Comparison of the calculated temperature field with the actual field shows the possibility of using the proposed model for studying the principles of formation of the soil temperature regime in the base of buildings erected on cold piles.

REFERENCES

- BUCHKO N.A. An algorithm for the numerical solution of a two dimensional Stefan problem by the enthalpy method for an explicit three layered scheme. In the book: Refrigeration and cryogenic techniques and technology. Leningrad, pp. 142-154, 1975.
- KUDRYAVTSEV V.A., GARAGULYA L.S., KONDRAT'EVA K.A. and MELAMED V.G. Fundamentals of permafrost forecasting in the course of geological engineering research. Pub. of Moscow State University, 431 pages, 1974.
- MAKAROV V.I. Files with built in individual cooling devices. Construction on permafrost. Vol. 5, No. 3, Krasnoyarsk, pp. 116-124, 1970.
- MOLOCHNIKOV A.D. and TRET'YAKOVA G.V. Results of field studies of installations with natural circulation of a fluid refrigerant for freezing soils in hydrotechnical construction. Problems of northern construction, coll. 2, Krasnoyarsk, pp. 44-49, 1973.

STRENGTH AND STABILITY OF RAILWAY SUBGRADES IN PERMAFROST REGIONS

N.A. Peretrukhin

All-Union Scientific Research Institute for Transport Construction,
Moscow, U.S.S.R.

INTRODUCTION

The railway subgrade is a linear structure which crosses regions with different permafrost and soil conditions. Difficulties in ensuring the strength and stability of the subgrade usually arise in sections with complex permafrost, soil, and other natural conditions. The complexity of natural conditions is determined by the presence of: clayey, waterlogged, frost-susceptible soils in the active layer; peat deposits ("mari" - swampy sparse larch forests interrupted by hummocky bogs); ice saturated permafrost; ground ice very close to the surface and other permafrost phenomena (icing, thermokarst).

Generalization of experience in the design, construction, and operation of railroads in permafrost regions reveals that deformation usually affects individual parts or local sections of the subgrade. The total length of such sections is usually found to be very small in relation to the length of the railway line. The presence of parts of the subgrade which are subject to deformation, however, significantly complicates maintenance of the route under normal railway operating conditions, necessitating reduction of train speed, and sometimes stoppage of train traffic altogether.

In view of the above, the basic problem which must be solved during the design of the subgrade is determination of the areas where deformation of the subgrade is most likely to occur, and designation of

measures to completely eliminate the possibility of disruption of the strength and stability of the subgrade. This problem is found to be exceedingly difficult if we take into account the fact that the appearance, development, and continued existence of deformation of the subgrade are random processes, inasmuch as they are determined by the interaction of a number of natural and artificial factors, including: climatic (air and precipitation temperature); physico-technological (subgrade soil types, their construction and thermo-physical properties when frozen and unfrozen, frost heaving properties of the soils of the active layer); hydrological (presence and chemical composition of groundwater, its natural regime, sources); topographical (local relief, elevation, angle of slope); biological (type of ground cover and its role in the formation of natural permafrost and soil conditions); ecological (susceptibility of permafrost and soil conditions to change when the natural environmental regime is altered); engineering and technological (drainage, flooding or levelling of an area, removal or disruption of the vegetation, erection of industrial structures, etc.). The numerical values of the parameters which characterize the above factors are variables which change along the route, and some factors cannot be quantitatively evaluated at all. For this reason, the question under discussion does not have a single solution.

TWO DESIGN APPROACHES

There are presently no standard methods for determining the probable locations at which deformation of the railway subgrade will occur. For this reason, such locations are assumed to include all sections with complex permafrost and soil conditions. The main indicator of possible deformation of the railway subgrade is usually considered to be the presence of ground ice or of ice saturated permafrost having a thaw settlement of 0.10.

There are two approaches to the selection of engineering solutions in the design of the subgrade: with the first method, special measures are taken to maintain the permafrost; the second method involves measures against deformation.

Industrial experience shows that the engineering solutions used with both methods ensure the required strength and stability of the subgrade. In terms of volume and cost of earth moving and stabilizing operations, the indicators are poorer for the engineering solutions which are calculated to maintain permafrost.

PRESERVATION OF PERMAFROST

The main methods which are used to preserve permafrost in the subgrade and along the slopes of cuts can be classified into two groups:

A. Constructional, including: embankments of "optimum" height, as determined by thermo-technological calculations; berms on both sides of embankments, the berm dimensions being established on the basis of construction considerations; removal of clayey ice saturated soils from cuts in the base and their replacement with rock or crushed stone to a depth equal to the "optimum" embankment height, widening of cuts, and cushioning of slopes with rocky or stony earth at least 3 m thick.

B. Technological, intended to preserve the natural vegetation and moss cover at the base of embankments and in adjoining areas; performance of earth moving operations in winter; buildup of embankments "from the head" when performing earth moving operations in summer.

There are proposals to include thermal insulation (a layer of peat, foamed plastic, etc.) in the base of embankments and on the slopes of cuts.

Methods of keeping permafrost from thawing have technological and economic limits of practicability. Thus, it is practically impossible to prevent the thawing of permafrost which has a temperature of -0.5°C and above. Thermal engineering calculations have shown that in order to prevent the thawing of permafrost which has a temperature above -1°C embankments at least 5 m high must be used, which is, of course, impractical.

Cases are known of the implementation of decisions to preserve permafrost at temperatures of -1.5°C to -3°C . They resulted in a significant

increase in earth moving operations (Peretrukhin, Minailov, 1976). Nevertheless, the probability that the real course of the thawing-freezing process will coincide with the computed version, which is intended to keep the permafrost from thawing, is very low (Pereselenkov, 1976). This is explained by the great nonuniformity of the natural conditions along the projected railway line, by the significant and unavoidable disturbance of the natural conditions caused by construction, and also by the imperfect nature of the methods used to make engineering evaluations of many factors, including: the natural permafrost, soil, climatic, and other conditions along particular sections of the line; changes in natural conditions, including those which determine the natural permafrost regime, as a result of construction of the line; the interaction of the subgrade with the permafrost of the base; the correspondence of computational schemes, assumptions, and calculation results to the actual starting conditions and to the principles of interaction of the "subgrade - permafrost" system. The probability of preserving permafrost which is at a temperature below -2°C increases, even when it is under subgrade of standard construction. This is determined, first of all, by the lesser sensitivity of low temperature soils to changes in their natural conditions caused by construction of the line, and also by the more severe climatic conditions in such regions.

FORECASTING CHANGES IN PERMAFROST CONDITIONS

Forecasting is required in order to obtain initial data for planning the subgrade and to substantiate the design solutions. The forecasting method must provide initial data for evaluation of the natural permafrost, soil, hydrogeological, and other natural conditions, and changes in them which are caused by the construction of the subgrade. These requirements are met by the method of engineering analogies, which is based on the logical assertion that: if the formation of natural permafrost, soil, hydrogeological, and other conditions, and changes in them which arise in the course of construction activities in a particular section of the line, are characterized by certain principles then within the confines of other sections of the line with similar natural conditions and the same set of construction activities the processes of change in the permafrost, soil, hydrogeological, and other natural conditions, as well as stabilization of

the erected structures, conform to the same principles. Indication of analogy should be considered to be the equivalence of limits of regular changes in the numerical values of the parameters which characterize the phenomena and processes under consideration. It is expedient to view the following as such parameters: the depth of the active (seasonally thawing-freezing) layer of earth under natural conditions; the depth at which the permafrost table is found in the subgrade base and within the zone affected by it; the temperature and other physico-technological characteristics of the permafrost; the construction properties of the soils of the active layer, of permafrost, and of thawing earth; indicators of the stability and deformability of the subgrade, the soils comprising its base, etc. These are generalized parameters which reflect the end results of the interaction of all natural and artificial factors under the given climatic conditions. They can be measured and ascertained directly by known methods which are used in geological engineering and permafrost surveys, as well as in soil mechanics and soil science. At the same time, it must be taken into account that the presence of and change in permafrost, soil, hydrogeological, and other natural conditions along the projected railway lines are random processes. The combinations of interacting factors which govern these processes, and the role of each of these factors, are variable and different. For this reason, the numerical values of the generalized parameters which characterize the permafrost, soil, hydrogeological, and other natural factors and the changes in them should be viewed as random variables of a probability nature. The numerical values of the generalized parameters, as determined within the confines of each section in sufficient numbers and with the required degree of precision and reliability, are statistically analyzed and are used to establish certain criterial functions. They are also used in calculations of the stability, strength, and deformability of the subgrade, its base, and slopes. The minimum number of measurements which is required to obtain the value of each of the generalized parameters for stochastic treatment depends on the variability of the local conditions and on the required accuracy of the engineering solutions; as the conditions in the sections of line (analogs) being studied become more diverse, and as the required accuracy of the engineering solutions increases, the survey must be carried out with greater detail and consequently, more measurements and determinations need to be carried out. The accuracy of the measurements is

determined by the capabilities of the methods, instruments, and equipment used, as well as by the nature of the process being studied. The accuracy or reliability of the data obtained is of paramount significance. It depends on the correct selection of sections of line as analogs, on the qualifications of the technicians, the knowledge of the researcher, and the refinement of the research methods and organization (Kopalov, Sidorchuk, 1974).

Typical sections (in terms of geomorphological, lithological, hydrogeological, and other natural conditions) of the railway line and of the subgrade, including drains and channels for water, or individual railway lines, need to be chosen as analogs. Both the routes of existing and of proposed lines can be used for this purpose. By distributing analogs to cover the entire extent of new lines it is possible to establish, with the required degree of accuracy, the initial data which characterize the natural permafrost, soil, and other conditions during the preconstruction period, and also to establish the mechanisms of change with time of the natural conditions and stabilization of the subgrade and its base in the course of construction and during the period of operation. It takes many years of research, however, to compile such complex data with a sufficient degree of reliability. When section analogs are chosen along existing railway lines a shorter period of time is needed to obtain data characterizing the local permafrost, soil, and hydrogeological conditions, as well as the condition of the subgrade. In such cases, data on the preconstruction natural conditions are taken to be the results of determination of the numerical values of the generalized parameters beyond the zone affected by the subgrade. Such data should be considered to be hypothetical, and the mechanisms determined on their basis as less reliable and requiring theoretical and experimental substantiation within the context of new construction. The method of engineering analogies takes into account the use of results of thermal engineering calculations for the theoretical generalization of experimental research data. This takes into account inclusion in the calculations of initial data on permafrost, soil, and climatic conditions within the confines of the sections under consideration, including the presence of plant, moss, and snow cover, and their thermal engineering characteristics in the natural state and when interacting with the subgrade.

MECHANISMS OF INTERACTION

The mechanisms of interaction of the subgrade with seasonally frozen ground and with permafrost are manifested in the deformation of the soils of the base, in changes in the thickness of the active layer and position of the permafrost surface, and in stabilization of the subgrade as a new thermal regime for the permafrost is established.

Permafrost is classified as low temperature and high temperature, depending on the degree to which the thermal regime is susceptible to changes. The low temperature type is permafrost whose temperature is -1°C and lower at zero amplitude depth, while the high temperature type is permafrost at a temperature above -1°C , or permafrost islands regardless of their temperature (Peretrukhin et al., 1975). The surface of low temperature permafrost which is at a temperature of -1.0 to -2.5°C is preserved at its natural depth of occurrence beneath embankments of 1.5 to 2 m; this surface drops beneath embankments which are less than 1.5 m high, and rises beneath embankments higher than 2 m. The depth of the surface of high temperature permafrost drops beneath embankments of various heights.

A new active layer develops about the contours of depressions and drainage ditches. The thickness of this layer depends on the local natural conditions and the degree to which they are disturbed during construction of the subgrade. The thickness of the active layer which forms beneath drainage ditches with a standard cross section is roughly equal to the depth of the ditch. Clayey soils and peat within the active layer, and within thawing permafrost in the base of the subgrade, are deformed by train loads and by the weight of the embankment, which leads to settlement of the subgrade. The total extent and intensity of settlement of embankments depend on the condition and properties of the soils of the active layer and of the thawing permafrost, the height of the embankment, the duration and methods of earth moving operations, and the level of damage to the plant and moss cover and the natural surface and ground waters regime.

The size of areas of settlement and their rate of formation under given climatic conditions decrease with increasing strength of the soils of

the active layer and of the thawing permafrost. They increase with increasing embankment height, thickness of the active layer under natural conditions, degree of drop of the permafrost surface in the base, and degree of damage to the plant and moss cover and the natural surface and groundwater regime. Under given climatic conditions the plant and moss cover, and the surface and groundwater regime, are the main factors determining the thermal regime of permafrost. For this reason damage to and, all the more so, removal of the plant and moss cover in the base of embankments and drainage of swampy or flooded non-swampy areas in sections with ice rich permafrost, or with ground ice which is very close to the surface, results in intense, irreversible, and practically uncontrollable thawing of the permafrost coupled with lowering of the permafrost surface depth, and an increase in the rate, duration, and total extent of settlement of the subgrade. Settlement of the subgrade in such sections is not amenable to control (Peretrukhin et al., 1975).

Embankment settlement resulting from deformation of the soils in the active layer is caused by earth moving operations which are performed during the warm parts of the year. Erection of embankments in winter leads to a significant decrease in the intensity and extent of settlement, and the subgrade stabilization process is practically completed during the period of construction (2-3 years).

Settlement of the subgrade in cuts, and settlement of embankments less than 1.5 m high, which appears as the result of deformation of thawing low temperature permafrost in the base, may arise during formation of the new active layer over the course of 1-2 years after construction of the subgrade. Settlement of embankments, which occurs as high temperature permafrost thaws, begins during construction of the subgrade and may continue for a long period once the railroad is in operation (Peretrukhin, Potatueva, 1974).

MEASURES AGAINST DEFORMATION

Measures against deformation are additions to standard subgrade designs, and to the organization, techniques, and methods of carrying out earth moving operations. They are undertaken with the aim of: decreasing

the extent and intensity of deformations of the subgrade, which are due to the deformability of the soils of the active layer and of thawing permafrost; decreasing the time, labor, and material costs which are required to eliminate settlement of the subgrade appearing during the operational period; making provision for the strength of the roadbed; including sections with frost-susceptible soils in the base, as well as stability of slopes.

All of the measures against deformation can be classified as either design measures or organizational and engineering measures. Design measures include: widening of the subgrade, construction of berms, replacement of weak base soils with draining soils, selection of the proper location and design of structures and facilities for the drainage and channelling of water. Organizational and engineering measures include: good techniques for carrying out the earth moving operations, allowing for the preservation of the plant and moss cover, or causing minimal damage to it; sound organization of work, providing for winter construction of embankments in sections with a weak base or one subject to subsidence; use of rocky and coarse grained soils, which have good building properties, in the construction of embankments. Research has shown (Peretrukhin, Potatueva, 1974) that most of the total settlement of the subgrade (up to 80%) occurs during the period of construction, while the remainder takes place under operating conditions. Work to eliminate settlement of the subgrade during the operational period does not meet with any particular difficulties if we take into account that the annual settlement is, as a rule, insignificant and can be compensated for in the course of routine and planned maintenance of the route. For this reason the subgrade is widened in sections where settlement, which occurs during the operational period, is to be eliminated by raising the track onto ballast. The amount by which the subgrade is widened is determined on the basis of the expected degree of settlement.

Berms are viewed as a means of protecting the slopes of embankments from creep. Their use is recommended in sections with ground ice and in the vicinity of "maris". The advisability and effectiveness of using berms have so far not been confirmed either experimentally or in practice.

The removal of clayey frost-susceptible base soils, whose bearing capacity is inadequate, and their subsequent replacement with draining

material, is carried out mainly in cuts and at approaches to them. This solution is an effective means of preventing deformation of the subgrade as the base soils freeze and thaw. The thickness of the replacement layer must be established in accordance with set standards (Construction Norms, 1973), or on the basis of results of computations which take into account the condition and properties of the base soils and the size of the external load. The cuts must also be provided with reliable drainage.

The slopes are stabilized by setting their angle on the basis of permafrost displacement characteristic values after it has thawed, and by planting grass on the slopes. Clayey soils usually have a high moisture content after thawing. For this reason it is advisable to grade the slopes to the required angle and stabilize them with vegetation 1-2 seasons after construction of the cut and formation of a new active layer along its perimeter (Peretrukhin, Potatueva, 1974).

DRAINAGE

Structures and facilities for draining and channelling water in sections with complex permafrost and soil conditions should be selected and located in such a way as to cause minimal disruption of the natural surface and groundwater regime. All possibility must be removed of flooding non-swampy areas or draining swampy locations in sections with ice rich permafrost or with ground ice.

Decreasing the number of structures for channelling water and passing surface water from one reservoir to another using drainage channels is not permitted within such sections. It is preferable to allow free transverse circulation of surface and suprapermafrost water. With this aim, it is recommended that, in addition to the usual channelling structures, transverse drainage cuts be made, using stony soil and located along local depressions and runoff belts which intersect the railway line, if the entire embankment is made of non-draining soils (Merenkov et al., 1975).

The surface depth of ground ice must be taken into account when establishing the depth of drainage ditches. Drainage ditches may not be used

in sections where ground ice lies close to the surface. If embankments are constructed entirely of rocky soil along the entire extent of a section with ground ice the problem of surface water drainage is eliminated. Embankments of rocky soil do not disturb the natural regime of surface and ground waters, and the need to construct drainage ditches and berms on the upland side of the subgrade practically disappears.

SECTIONS PRONE TO ICING

Sections which are prone to icing are portions of the railway line in which icing does or may occur after construction of the line (Bol'shakov, Peretrukhin, 1973). Railway lines usually have to be laid beyond the bounds of areas which are prone to icing. However, for engineering and economic reasons, this is not always possible. As a result, it is necessary to consider the various types of icing and their effect on the subgrade (Peretrukhin, 1966).

In sections which are prone to icing, the subgrade must be designed and constructed as an integral part of the drainage, channelling and anti-icing structures and facilities. Changes in permafrost, soil, and hydrogeological conditions which can occur as the result of the construction of road and other structures must be taken into consideration.

The greatest changes occur in the vicinity of cuts and drainage ditches which intersect the flow of groundwater and which significantly alter the freezing and thawing conditions of the soils of the active layer. Changes in permafrost, soil, and hydrogeological conditions also occur in sections where the embankments are constructed of clayey soils, as a result of the decreased cross section of the permeable layer in the subgrade base. Icing is most likely to occur in such sections after the construction of railway line structures or during earth moving operations.

It must be kept in mind during the design stage that the primary aim in sections which are prone to icing, is to protect the subgrade from the direct effects of the icing. Anti-icing structures (fence, earth barriers) are used for this purpose. Their location and design are based on the

origin, discharge, and paths of flow of the water which feed the areas of icing, and on the local terrain. The anti-icing structures should be so located as to also serve as guides for the flow of unfrozen water. Location of the fence of earth barrier at an angle rather than parallel to the slope gives the base of the fence or barrier the necessary longitudinal incline, which facilitates the concentration of water flowing on the icing and its diversion in the desired direction (away from the subgrade or toward a drain). The most effective anti-icing measure is the interception or damming of ground (subterranean) water (by means of drains or deep ditches) and its diversion in a concentrated stream (through pipes or covered races) downslope from the subgrade. In order for such anti-icing measures to be well-founded, however, reliable data must be available on the hydrogeological, permafrost, and soil conditions in the section under consideration.

The brows of embankments in sections which are prone to icing must be at least 0.5 m higher than the icing surface, if it will form in the immediate vicinity of the subgrade. The use of rocky, coarse grained or sandy soils is recommended. Berms and the necessary reinforcement must be included on the downslope side in the design of embankments constructed of clayey and other non-draining soils (Peretrukhin, 1966).

CONCLUSIONS

The problem of ensuring the strength and stability of the railway subgrade involves a number of questions, including: determination of the line sections in which deformations are likely to occur; forecasting of changes in the local permafrost, soil and hydrogeological conditions as the result of construction of railroad structures; quantitative evaluation of the interaction of the subgrade with the soils of the active layer and the permafrost; designation and calculation of measures to prevent deformations.

The available industrial experience and the present level of knowledge in the field of engineering geocryology make it possible to arrive at positive solutions to the majority of problems which arise in the course of surveying a railway line and designing the subgrade. The need to optimize engineering solutions, however, with the aim of decreasing work volume,

length of construction, building costs, and operational expenses to maintain the subgrade (which ensure uninterrupted train traffic at the proper speed in sections with complex natural conditions), requires additional research.

REFERENCES

1. BOL'SHAKOV S.M., PERETRUKHIN N.A. The geological engineering analogy method as a basis for forecasting icing processes. In: Problems of Icing Formation. Chita, pp. 30-33, 1973.
2. KOPALOV V.A., SIDORCHUK V.I. Determination of thaw consolidation of permafrost on the basis of vertical well logging data. Transportation Engineering, No. 12, pp. 38-39, 1974.
3. MERENKOV N.D., GULETSKII V.V. and MINAILOV G.P. The use of drainage cuts for draining subgrade on maris. Transportation Engineering. No. 9, pp. 4-5, 1975.
4. PERESELENKOV G.S. Reliability of calculations of the temperature regime of embankments on maris. Transportation Engineering, No. 7, pp. 44-46, 1976.
5. PERETRUKHIN N.A. Special features of subgrade in sections with icing. In: The struggle against icing on railroads and highways. Moscow, "Transport" Pub., pp. 29-40, 1966.
6. PERETRUKHIN N.A. and MINAILOV G.P. Ways to decrease the volume of earth moving operations during construction of the Baikal-Amur Railroad. Transportation Engineering, No. 8, pp. 41-42, 1976.
7. PERETRUKHIN N.A. and POTATUEVA T.V. The effect of railway subgrade construction on the condition of permafrost. Transportation Engineering, No. 11, pp. 36-37, 1976.
8. PERETRUKHIN N.A., TSVELODUB B.I., MINAILOV G.P. and SOLODOVNIKOV B.I. Construction of subgrade on maris along the Baikal-Amur Railroad line. Transportation Engineering, No. 2, pp. 4-6, 1975.
9. Special features of the design of subgrade on maris along the Baikal-Amur Railroad line. Transportation Engineering, No. 3, pp. 44-45, 1975.
10. Construction Norms and Regulations II-39-76, 1,520 mm gauge railroads. Moscow, Stroiizdat, 1977.
11. Construction Norms 449-72. Instructions for the design of railroad and highway subgrades. Moscow, Stroiizdat, 113 pages, 1973.

CONSTRUCTION OF EARTH EMBANKMENTS FOR HIGHWAYS IN WESTERN SIBERIA

B.I. Popov, N.F. Savko, N.M. Tupitsyn, Yu.K. Kleer and A.S. Plotskii
All-Union Research Institute of Roads and Highways (Omsk Branch), U.S.S.R.

The rapid rates of development of oil and gas extraction in northern regions in Western Siberia have called for accelerated construction of highways with improved surfaces. Exceptionally complicated natural conditions (a universally swampy terrain, the presence of continuous permafrost and permafrost islands, a prolonged winter period with low air temperatures, a short wet summer and a lack of high-grade free-draining soils) are a characteristic feature of these regions.

Insufficient experience of designing and building highways in this region made it necessary for the Omsk Branch of the All-Union Research Institute of Roads and Highways to carry out special investigations based upon the idea of effective utilisation of the potential of nature and of weak ground (unfrozen and ice-saturated permafrost peatland) as the foundation for highway construction.

A specific feature of the climate in the region north of 58°N is a negative average annual balance of atmospheric heat, indicating the existence of a permafrost layer. In Western Siberia, however, the southern permafrost boundary passes along 64°N . The absence of permafrost, or its occurrence as islands only between 58°N and 64°N is due to the thick snow cover (up to 70 - 80 cm) here during the winter period; this protects the waterlogged topsoil from excessive cooling and reduces the depth of ground freezing substantially.

North of 64°N , permafrost is widespread over enormous areas of forest-tundra and tundra. The variety of types of tundra, among which

peat-hillocky, hillocky, hummocky dwarf birch types and tundra with non-sorted circles are the most frequently encountered, gives rise to a variety of permafrost temperature conditions and to various depths of permafrost occurrence at the end of the warm season.

In zones of discontinuous distribution, the temperature of the permafrost is above -2°C and the depth of seasonal thawing varies from 0.5 m in the peatlands to 3 m in sandy ground. Thermokarst is widespread. Areas occupied by taliks account for up to 30 - 40% of the territory and are confined to river floodplains and sand terraces with a southerly or south-westerly aspect.

In zones of continuous distribution, the temperature of the permafrost (at a depth of 10 - 12 m) is -2 to -5°C or lower; the depth of seasonal thawing in the peatlands does not exceed 0.3 - 0.5 m and 2.0 - 1.5 m in clay and sandy ground. Frost mounds ranging in height from 0.7 to 20 m are widespread, and thermokarst phenomena can be seen everywhere.

The earth embankment should be designed according to the following well-known principles of these climatic and permafrost conditions:

- firstly, the upper level of the permafrost should be brought up to the base of the fill and kept at that level throughout the period of road use;
- secondly, the depth of foundation ground thawing should be restricted.

Theoretical studies have shown that a real opportunity exists for artificial formation of frozen foundations under an earth embankment or marshes when there is a negative average annual air temperature balance. This can be achieved by controlled increases in the severity of temperature conditions and by increasing the depth to which peaty ground freezes within the road zone. This hypothesis can be implemented in practice if the surface of the marsh (mari) is systematically cleared of snow during the winter period and special peat slabs (foundations) are frozen onto it.

The structure of a highway on a frozen foundation includes the following (Figure 1): the road surface, an earth embankment of mineral soil, a frozen-on peat slab, a peat foundation consisting of frozen and unfrozen layers of the natural peat bed (or ice-rich soils), and lateral insulating banks of peat. The type I structure is provided on type I-II marshes, and the type II structure in permafrost zones represented by frozen peatlands.

Figure 1

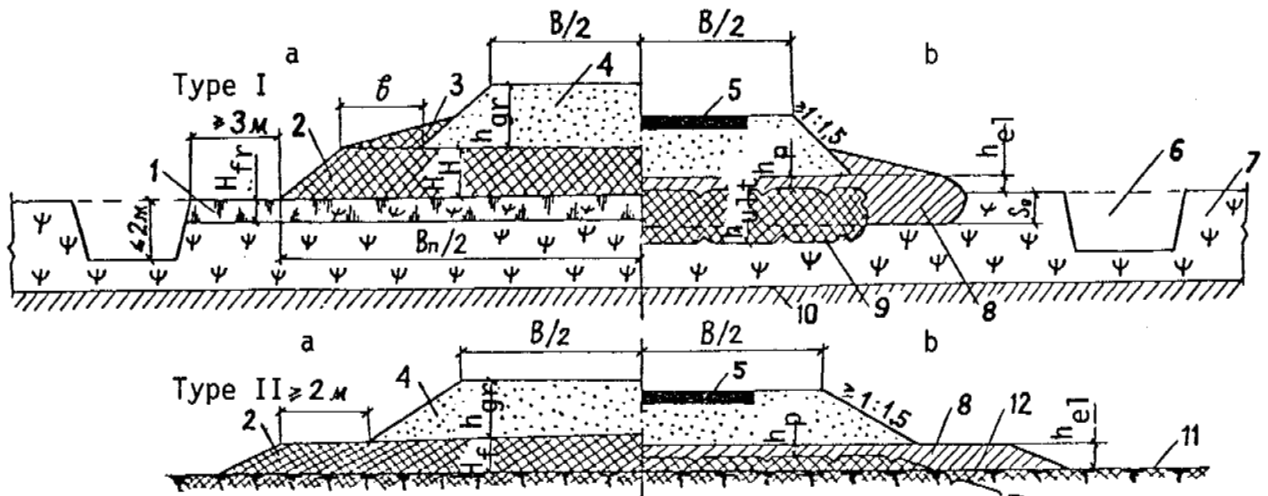

Cross sections of roads on frozen foundations:
 a) - state during the construction period; b) - ditto, in the process of operation at the end of the warm season; 1 - frozen peat layer; 2 - frozen-on peat slab; 3 - side banks of peat; 4 - mineral soil fill; 5 - road surface; 6 - side borrow pit; 7 - unfrozen layer of peat; 8 - unfrozen layers of peat slab; 9 - limit of frozen peat foundation; 10 - mineral bottom of marsh; 11 - permafrost table after construction of road.

The frozen layer of the peat foundation and the frozen-on slab spreads the load from the weight of the fill, and the vehicles upon the unfrozen foundation layers, which reduces the extent of settlement. Using a frozen-on slab in the lower part of the fill reduces the amount of mineral soil brought in and makes it possible to keep the mineral part of the fill clear of the zone of constant wetting. Having regard to the fact that the strength characteristics of frozen peat are far superior to those of unfrozen peat and mineral soils, the overall stability of a structure with a frozen foundation is greater than, for example, the stability of floating fill on marshes.

The design parameters of roads on frozen foundations are fixed according to heat engineering and strength calculations, taking into account the climatic conditions in the construction region, the type of marshes, their depth and the level of long-standing water, the physical and mechanical properties of the peats and mineral soils, and the composition and intensity of the traffic.

The results of extensive experimental construction work and observations of the operation of roads on frozen foundations over many years have revealed the conditions which must be observed to guarantee the strength and stability of roads during the course of construction and operation:

$$H_f \geq h_{el} + h_{cwl} + S_f + S_s \quad (1)$$

$$H_{fr} + H_f \geq H_a \quad (2)$$

$$B_w \geq B_{gr}^M + 2b; B_w \geq B_{us} \quad (3)$$

$$h_{gr} + H_f + H_{fr} \geq H_{el} \quad (4)$$

$$t_0 \leq 0^\circ\text{C} \quad (5)$$

$$h_{th} \leq h_p; h_{fr} > h_{gr} + H_f + H_{fr} - h_H \quad (6)$$

$$h_{su} + h_{gr} + H_{fr} + H_H - h_{th} - h_u \geq h_{ult} \quad (7)$$

$$h_{ult} \geq h_{th} \quad (8)$$

where H_f is the thickness of the frozen-on peat slab, m;

h_{el} is the elevation of the top of the peat slab above the calculated water level in the marsh, m, defined subject to the condition that the mineral soil does not exceed the permitted moisture content of the boundary with the peat;

h_{cw1} is the calculated water level in the marsh, m, in the absence of long-standing surface water (over 20 days); the surface of the marsh and $h_{cw1} = 0$ is adopted as the calculated level;

S_f and S_s is the settlement of the peat foundation and of the frozen-on peat slab with maximum thawing from above during the construction period, m;

H_{fr} is the thickness of the frozen peat layer, m, which is fixed according to the load-bearing capacity of the peat (see Table I);

B_w is the required width of the frozen peat slab during construction of the earth embankment, m;

B_{gr}^M is the width of the mineral part of the fill at the base, m;

b is the width of the shoulders for the protective peat banks; $b = 3h_{gr}$, where h_{gr} is the height of the mineral part of the fill at the edge, m;

h_p is the permitted depth of thawing of the frozen-on slab to ensure the required structural strength in operation, m;
 h_p is from 0.25 to 0.5 m, depending upon the road category;

B_{us} is the minimum slab width at which buoyancy of the structure is maintained during the period of construction and stabilisation of settlement, m; $B_{us} \geq 24$ m;

H_{el} is the fill depth at which unacceptable elastic deformations are eliminated, m;

t_0 is the mean annual temperature of the frozen foundation on a base thawing seasonally from above, calculated from mean climatic data over many years, °C;

h_{th} is the depth of thawing in the frozen-on peat slab in a year averaged over many years, m;

h_{su} is the thickness of the road surface, m;

h_{gr} is the thickness of the mineral soil layer along the road axis, m;

h'_{th} is the depth of thawing of the multilayer road structure from above in the warmest (calculated) year, m;

h_{fr} is the depth of freezing of the multilayer road structure from above, m;

h_{ult} is the ultimate thickness of the frozen peat slab, which is set to ensure strength, stability and fatigue resistance during the period of operation of the structure after complete consolidation of the peat foundation, m; h_{ult} varies from 0.6 to 0.3 m, depending upon the type of road cover and the type of marsh;

h_H is the extent of thawing of the frozen foundation from below due to the influx of heat from the unfrozen peat layer, m; for conditions in Western Siberia $h_H > 0.1$ m.

TABLE I

Minimum thickness of peat foundation

Resistance to shear of upper peat layer as determined by a compressor r_{sh} , kgf/cm ²	>0.1	0.1-0.05	<0.05
H_d , m	1.00	1.15	1.30
Minimum H_{fr} , m	0.40	0.45	0.50

These values are found by calculation, using "Method Recommendations for the Design and Construction of Roads on Frozen Foundations in Marshy Regions in Western Siberia" (Moscow, 1975) as a guide.

In permafrost regions where the active layer is shallow there is no necessity for freezing-on the peat slabs; the foundation materials are kept frozen by building up the earth embankment to the height required by heat engineering calculations, which is from 2 to 3 m.

Investigations by the Omsk Branch of the All-Union Research Institute of Roads and Highways have shown that the depth of fills and consequently the amount of earthmoving and its cost can be substantially reduced if insulating layers of natural or artificial materials are used extensively in the structures. In these circumstances the structure of the earth embankment includes a levelling sand layer and an insulating covering of plastic foam, expanded polystyrene or polyurethane slabs, above which is laid a soil layer of calculated thickness (Figure 2).

Figure 2

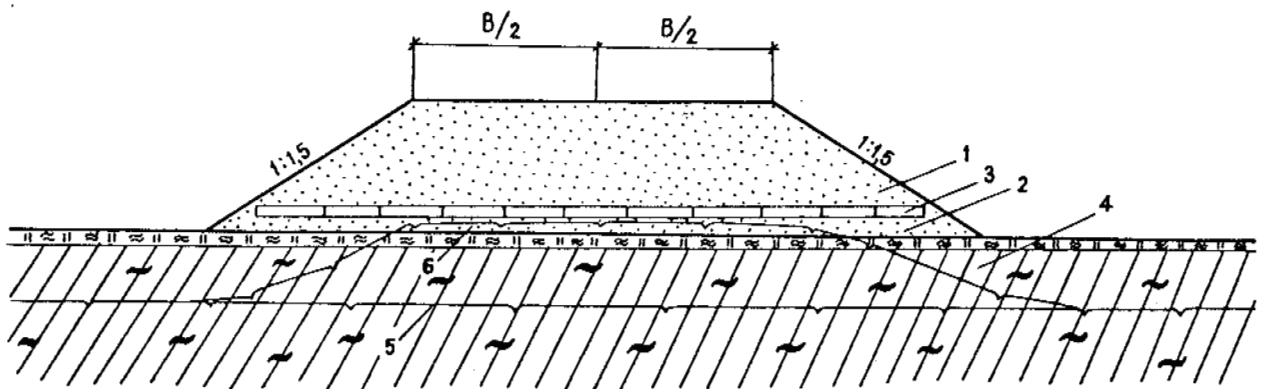

Structure of earth embankment with plastic foam
(expanded polystyrene) insulating layer:

1 - fill soil; 2 - levelling (erecting) layer of sand; 3 - insulating layer of plastic foam or polyurethane; 4 - ice-bearing suglinok; 5 - permafrost table before construction; 6 - the same, after construction.

In areas with frost mounds the structure of the earth embankment is fixed according to their dimensions. On ice-bearing suglinok foundations where small frost mounds (up to 0.4 - 0.6 m in height and up to 4 m in

diameter) are present, these are preserved in the foundation. To prevent the infiltration of rainfall to the frost mound, the lower part of the fill is made up of a layer of clay soil equal in thickness to the height of the mound plus 0.2 - 0.3 m. An insulating layer is provided if the diameter of the mound is 5 - 6 m and its height reaches 1 m or more.

Where it is impossible to skirt an active frost mound (hydrolaccolith) of large size (over 8 m in height) it is removed and an insulating layer of artificial or natural materials (moss, peat) is provided in the lower part of the earth embankment.

The thickness adopted for the insulating layer of peat-moss is 0.25 - 0.30 m in the consolidated state, and the depth of the fill is calculated by the formula

$$H = H_{1c}^p m_c - \left[\frac{H_1^p}{H_{a.1}} \left(\frac{1}{S_f} - 1 \right) + 1 \right] S_d - \frac{H_1^p}{H_2^p} h_2, \quad (9)$$

where $H_{1,2}^p$ is the calculated depth of thawing of fill soil and insulating layer respectively, m;

$H_{a.1}$ is the thickness of the seasonally thawing active layer, m;

m_c is a coefficient defining the thermal influence of the covering (a dimensionless value);

S_f is the settlement of the foundation soils, in fractions of unity;

S_d is the permitted settlement for coverings of various types, m;

h_2 is the thickness of the insulating layer, m.

In broken terrain where there are unstable slopes with gradients from 1 : 5 to 1 : 10 and downslope movements (a solifluction phenomenon) of

fine sands, supes and ice-bearing suglinoks, the earth embankment is designed with a built-up shoulder of peat-moss on the lower side and a raised frozen ridge; the dimensions of these are fixed by heat engineering calculations. The width of the shoulder at the top must not be less than 3 m and its height not more than two-thirds of the height of the fill. The surface of the shoulder is covered with clay soil with a layer thickness of 0.15 - 0.2 m. A frozen ridge 2 m wide at the top is constructed at a distance of not more than 20 m from the base of the fill and is provided with an insulating layer of peat-moss in its foundations.

The construction of roads on frozen foundations (see Figure 1) can be divided into four stages in time. The preparation work (working over the bog surface, clearing snow, moss and trees from the road zone) is completed in the first stage and the peat slab is frozen on layer by layer (autumn-winter period); in the second state (pre-spring period) the earth embankment is built up from mineral soils to part of its height and the insulating side banks of peat are constructed.

In the third stage (summer) the earth embankment is built up to its designed height. The fourth stage (laying the road surface) can be delayed indefinitely, to allow for the consolidation of sediments.

When crossing shallow lakes the water is frozen and a dry trench is made in the first stage of construction; the weak bottom deposits are frozen and the lower part of the peat fill is frozen on layer by layer.

In type I and II bogs the peat slab is usually frozen on in two stages, digging the peat from borrow pits on the two sides. In other cases the peat is obtained in open diggings in type I bogs and transported to the construction site by dump trucks. The peat is kept in ridges for 2 - 3 days to eliminate moisture, then levelled by a bulldozer.

Each peat slab layer (thickness 0.3 - 0.6 m) must be carefully consolidated by tractor tracks and frozen throughout its depth. The peat slab is finally finished off by transverse bulldozer runs, giving the surface a crescent shape; only then does laying of the upper part of the mineral soil fill begin.

From 1972 to 1976 dozen of kilometres of highway on frozen foundations in bogs and shallow lakes were built and kept under observation in oil-bearing regions in the Central Ob' district. The condition of the roads and traffic conditions on them are satisfactory. The observations confirm that a once frozen peat foundation of thickness $(H_f + H_{fr})$ is reduced by $(h_{th} + h_H)$ every year by the end of the warm period, but is restored to $(H_f + H_{fr})$ by the end of the winter period when the earth embankment is of optimum thickness by virtue of the excess cold in regions north of $58^{\circ}N$.

There are two periods in the construction of an earth embankment with insulating layers (see Figure 2): a preparatory period and the main period. The preparatory period is assigned to the beginning of winter, when the depth of freezing of the active layer is not less than 30 - 40 cm and free manoeuvring of road-building vehicles and equipment becomes possible.

During the preparatory period the road zone is cleared of snow, bushes and trees, the approach roads to the open-cut workings are built, the natural insulating material is procured, drainage installations (ditches, ridges etc.) are built, and large frost mounds are removed.

Snow, bushes and trees are removed only to the width of the fill foundation; grubbing out stumps is forbidden. In winter special winter roadways should be used as the approach roads to the open-cut workings, but by the beginning of summer a temporary earthmoving road 8 m wide at the top and 0.6 m high is laid. The natural insulating material is procured from sectors not less than 100 m from the line of the highway. As a preliminary the surface of the sectors is cleared of snow and the moss-peat is piled up by bulldozers. The frost mounds are removed by blasting or by mechanised methods.

The main period is assigned to the middle and the second half of the winter, when freezing of the active layer soils is practically complete and conditions favourable to preserving the permafrost in the road structure foundation are created. An earth embankment retaining frost mounds is constructed, observing the following rules: the lower part of the clay soil fill is built up in layers of 0.3 m from the edges to the middle, each layer

being carefully consolidated. If there is provision for insulating slabs, these are laid in a continuous layer with alternate joints. The slabs are covered with sand to a depth of 0.5 m.

The following sequence of operations is observed when constructing an earth embankment in sectors where frost mounds have been removed: the depression formed by removal of the frost mound is filled in with sandy soil and carefully consolidated; the peat-moss insulating layer is built up to the full height and levelled and consolidated by a bulldozer, and the earth embankment is built up. However, if there is provision for insulating slabs a sand levelling layer 20 - 25 cm thick without frozen lumps is laid and consolidated after removal of the frost mound, with grading of the surface on which the insulating slabs are laid in accordance with the above requirements.

The following procedure is used to build an earth embankment in a sloping sector with a built-up shoulder of moss-peat: the first layer of the earth embankment is built up to a height of 0.5 m, then a layer of peat-moss is built up on the shoulder. The soil is consolidated with a roller, the peat-moss with a bulldozer. The same procedure is used for subsequent layers of fill. In all the structures the lower layer of fill is built up "outwards", subsequent layers being laid longitudinally.

The soil for building the earth embankment is dug from open-cut workings using excavators equipped with face shovels or dragshovels and transported by dump trucks or motor scrapers running on pneumatic tires.

These earth embankment structures and building techniques have undergone extensive practical testing and have proved to be technically and economically efficient:

- roads on frozen foundations reduce the demand for bringing in mineral soils by 1.5 - 2 times by comparison with traditional methods of construction on bogs (complete peat removal, floating fills); in these circumstances the rate of highway construction increases by a factor of 2 to 2.5;

- insulating slabs of artificial materials from 4 to 10 cm thick permit reductions of 1 - 1.5 m in the height of the mineral part of the fill; in these circumstances the rate of highway construction increases almost threefold.

CONSTRUCTION BY THE METHOD OF STABILIZING PERENNIALY
FROZEN FOUNDATION SOILS

G.V. Porkhaev, R.L. Valershtein, V.N. Eroshenko, A.L. Mindich,
Yu.S. Mirenborg, V.D. Ponomarev and L.N. Khrustalev
Research Institute of Foundations and Underground Structures,
Moscow, U.S.S.R.

In regions of permafrost, all areas to be built over can be divided into two groups according to the frozen ground conditions: areas where the layer of seasonal freezing and thawing merges with the permafrost soils and areas where there is no such merging.

Conditions of the first type govern the choice of a method for construction of residential and public buildings in which the foundation soils are kept frozen (Vyalov, 1975). The design takes the form of foundations laid in the permafrost soil and the provision of ventilated air spaces or other cooling systems under the building. This method gives reliable and long-lasting structures if simultaneous provision is made to eliminate the thermal effects of buildings and structures located nearby upon the foundation soils. It is widely used in northern districts in the permafrost region.

The foundations of buildings and structures in these districts are permafrost soils, which are in the solidly frozen state and have high bearing capacity.

There are also examples of construction using plastically frozen soils as the base for foundations; in their natural state these soils have lower bearing capacity and high deformability characteristics. However, the foundation temperature can be reduced in a relatively short time (1-2 years)

by using the cooling system available in the building, for example a ventilated air space, transforming the soils from plastically frozen to solidly frozen and so increasing the reliability of the foundation. Having regard to the relatively short period of transition from the plastically frozen to the solidly frozen state and the rheological properties of the frozen soils, large deformations are not to be expected during this period, even at loads somewhat in excess of the ultimate long-term strength of the plastically frozen soils. Deformations in the foundation during this period may be calculated, but as a rule, they are insignificant.

Conditions of the second type do not unequivocally determine the choice of construction method. Here construction is carried out both with the foundation soils kept frozen and by using them in the thawing and thawed state (Zhukov, Pnomarev, 1973).

When the permafrost table does not lie at great depth and is within the range of ordinary pile or pier foundations, it is best to keep the foundation soils frozen. In this case the foundation rests upon permafrost soil, and the unfrozen layer above it is kept frozen during the period of use by the operation of the cooling system in the building or structure.

The method of keeping the ground frozen can also be used when the permafrost table lies at great depth, but in this case preliminary freezing is essential. First-group conditions are created artificially by preliminary freezing; the unfrozen soils of the foundation are transformed into solidly frozen soils and are then kept in that state. Until recently a mechanical method was used for preliminary freezing; this called for great expenditure and was therefore used on a limited scale. The range of application of this method of preparing foundations is expanding considerably with the introduction of conducting piles, which make it possible to freeze the ground to a great depth by natural cold.

However, a construction method using foundation soils in the thawing and thawed state is more widely used in areas where the layer of seasonal freezing and thawing does not merge with the permafrost. The design takes the form of foundations laid in the unfrozen layer of soil with an underlying permafrost layer.

If the underlying layer is relatively incompressible its thawing does not cause additional deformations, and the foundations operate as in unfrozen ground. Thawing can therefore be permitted while the structure is in use, irrespective of the depth of occurrence of the permafrost. However, this situation is rarely encountered. Normally permafrost produces large deformations when it thaws, and these are the principal cause of structural failure. Preliminary thawing of the permafrost is carried out to ensure the stability of the structure.

Two forms of thawing can be distinguished: complete and partial. The former is carried out when the permafrost is relatively thin, mainly in permafrost island regions; the latter is used in the remaining cases. In these circumstances the depth of preliminary thawing is set so that the total deformation of the foundation soils (settling of the unfrozen and thawed layers and of the layer which thaws during use) does not exceed the level which endangers the stability of the structure. Uneven deformations (tilting, sagging, arching, etc.) present particular dangers to the stability and operational suitability of the structure. Reductions in the unevenness of settling or elimination of its effect upon buildings can be achieved as follows: by increasing the depth of preliminary thawing, strengthening the structures of the building, and controlling unevenness in foundation soil thawing during use, i.e., by controlling temperature conditions in the foundation. For example, the depth of preliminary thawing for large-panel five- to nine-storey residential buildings to eliminate inadmissible unevenness in foundation soil settling may reach 25 - 30 m; this is not acceptable in practice from the technical and economic viewpoint. Strengthening the structure of the building is also fairly costly and does not always lead to the desired results.

The most acceptable method is to control the temperature conditions in the foundation, to eliminate inadmissible overall settling of the foundation soils while the building is in use and to prevent uneven settlements (Porkhaev, 1970).

Control may be exercised by means of cold air spaces, ventilated bridges, thermal insulation, and special heat sources (periodically operating

pipes or electric cables laid around the perimeter of the building or structure). Cold air spaces make it possible to reduce or even eliminate the thermal effect of the structure upon the foundation. However, when ~~the~~temperatures in the air space are low there is a probability of perennial ground freezing, which may cause heaving of the foundations.

The temperature conditions in cold air spaces must therefore be set on the basis of minimum probability of inadmissible deformations resulting from thawing of the permafrost or perennial freezing of unfrozen ground. The probability of inadmissible deformations can be reduced by increasing the depth of preliminary thawing or the depth at which the foundations are laid, or both together, as well as by thermal insulation around the perimeter of the structure and by bringing ventilated openings and special heat sources into operation.

However, the thermal effect of structures upon their foundation can be completely eliminated by means of cold air spaces and other cooling systems (pipes, channels, ventilated fills, and the like), thus avoiding thawing of the permafrost, i.e., stabilising the position of the permafrost table at its initial level.

This method of stabilisation involves positioning the foundations in the layer of unfrozen ground with underlying permafrost (Khrustalev et al., 1967).

A cooling device is provided in the building or structure to stabilise the position of the permafrost table; however, this device is brought into operation periodically, unlike a similar device used in buildings and structures in which the foundation soils are kept in the frozen state.

Let us consider the operation of a cooling device in the form of an air space with year-round ventilation by way of example. When the ventilation holes are open a negative mean annual air temperature is established in the air space, and there is perennial freezing of the ground in the foundation of the building or structure. By virtue of this a phase

boundary on which the freezing temperature is constantly maintained exists above the base of the foundations throughout the period of freezing. A second phase boundary is found below the foundations, at the level of the permafrost. Between the two phase boundaries lies a layer of unfrozen ground in which there are no temperature gradients; consequently there are no heat fluxes through it. Obviously the permafrost table retains its initial position while the no-gradient protective layer exists.

The danger of heaving of the foundations increases in proportion to the freezing. To avoid this phenomenon, freezing must not exceed a certain value, which is governed by the design of the foundations to resist the action of heave forces. The cooling system is shut down (the ventilation holes are closed) when this level is reached. The "short-term permafrost" which has formed is now thawed by the heat from the building or structure and the whole system returns to its initial situation. The cycle is then repeated. The reliability of this method is determined primarily by the depth at which the foundations are laid and the duration of the control cycle. The course of freezing and thawing is monitored by reference to the results of soil temperature observations in boreholes along the outermost and middle courses of the foundations.

Our investigations show that optimal conditions are created if a mean annual air temperature close to 0°C is maintained in the air space when the ventilation holes are fully open. In this case the sum of the degree hours in summer (positive temperatures) is equal to the sum of the degree hours in winter (negative temperatures). Taking account of the difference in thermophysical properties in frozen and unfrozen ground, the mean annual ground temperature in the layer of seasonal freezing and thawing will be somewhat below 0°C : of the order of -0.5 to -0.7°C . As a result, freezing of the ground below the limit of seasonal freezing and thawing will take place at a relatively slow rate. This rate will be greater at the edge of the building or structure than in the middle.

The course of freezing under the edge and the middle of a building or structure can be defined by the following formula:

$$\xi^F = \sqrt{(\xi_1^F)^2 - \frac{2\lambda_F T \tau_y}{B W} (d^F - 1)}, \quad (1)$$

where ξ^F is the depth of freezing of the ground under the middle (ξ_M^F) or edge (ξ_e^F) of the building or structure, m;

ξ_1^F is the depth of seasonal freezing of the ground under the middle or edge of the building or structure in the first year of the freezing period, m;

T is the calculation temperature, assumed to be F_1^F in calculating ξ_m^M and $0.5(T_1^M + T_2)$ in calculating ξ_e^M , °C;

T^F is the mean annual ground temperature in the layer of seasonal freezing and thawing within the periphery of the building or structure with the ventilation holes in the air space fully open, °C;

T_2 is the mean annual ground temperatures in the layer of seasonal freezing and thawing beyond the periphery of the building or structure, °C;

τ_y is the duration of the year, 8760 hr;

d^F is the duration of the freezing period, years;

λ_F is the thermal conductivity coefficient of the frozen ground, W/m.°C;

B is the heat of melting of the ice, J/kg;

W is the moisture content of the ground, kg/m³.

With the ventilation holes closed, the "short-term permafrost" which has formed will thaw during the period p^T , which can be found by the formula

$$d^T = \frac{B W [(\xi_c^F)^2 - (\xi_1^T)^2]}{2\lambda_u T_1^T \tau_y} + 1 \quad (2)$$

where d^T is the duration of the thawing period, years;

ξ_1^T is the depth of seasonal thawing of the ground under the middle of the building or structure during the first year of the thawing period, m;

T_1^T is the mean annual ground temperature in the layer of seasonal freezing and thawing within the periphery of the building or structure with the ventilation holes in the air space fully closed, °C;

λ_u is the thermal conductivity coefficient of the unfrozen ground, W/m.°C.

It is necessary to inject supplementary energy into the ground during the period of time d^U using special heaters placed around the perimeter of the building or structure to ensure simultaneous thawing under the middle and the edge; the magnitude of supplementary energy will be directly proportion to ξ_e^F .

The magnitude of ξ_e^F can be considerably reduced by shifting the outermost courses in the foundations towards the middle of the building or structure or by installing a ventilated opening communicating with the air space on the perimeter of the building or structure.

Calculations by the proposed method show that where $T_1^F = -0.5$ to -0.7°C freezing at the edge of the building ξ_e^F will reach a magnitude of the order of 3.5 - 4 m in 10 years of use.

As the calculations show, a depth of freezing of 3.5 - 4 m is the maximum in most cases to ensure freedom from heaving in the foundations of the building; the cooling system is therefore shut down and thawing of the short-term permafrost which has formed begins. The speed of thawing will be greater than the speed of freezing. Total thawing time will be 1 - 2 years. Thus the total freezing-thawing cycle with normal pile foundations will be 11 - 12 years. With an increase in the depth at which the foundations are

laid the duration of the control cycle can be increased until it is equal to the period of use.

The maximum preservation of the natural frozen-ground conditions which have historically formed by the time the territory is developed is one of the conditions contributing to increased reliability of buildings and structures erected using the stabilisation method. This condition governs the construction technology and the type of foundations used. The technology must ensure the minimum disturbance of the soil surface layer on the building site; the same is true of the type of foundations. Pile foundations meet these requirements most completely (Eroshenko, 1972), although the use of other types of foundations (strips, piers, slabs) is not ruled out in principle if this is dictated by the design or engineering features of the structures being erected.

The method of ensuring the stability of buildings and structures by stabilising the permafrost table gives rise to special requirements for pile foundation calculations and designs. The design of pile foundations is specified on the basis of two conditions:

- 1) maintaining the necessary bearing capacity;
- 2) the resistance of the piles to heaving under conditions of freezing.

The special features of calculating pile bearing capacity are determined by the effect upon it of the layer of annual freezing and thawing which is pierced by the piles. This effect is allowed for separately for the period of ground layer freezing under the building (with the cooling device operating) and when this layer thaws (with the cooling device shut down).

The bearing capacity of a pile will be at a minimum in the period when the ground under the building is thawing and is defined for this period with allowance for negative friction in the layer of freezing and thawing, which reduces the bearing capacity of the pile:

$$\phi = \frac{m}{K_r} \left[u \sum_{i=1}^n f_i l_i - u R_{Sh.n} \xi_e^F + RF \right], \quad (3)$$

where ϕ is the bearing capacity of the pile, N;

m and K_r respectively are coefficients of the operating conditions and the reliability of the soil foundation;

u is the perimeter of the pile cross section, m;

f_i is the calculated resistance of the i -th layer of foundation soil on the lateral surface of the pile, Pa;

l_i is the thickness of the i -th layer of soil in contact with the lateral surface of the pile, m;

n is the number of soil layers segregated over the length of the pile below the perennial freezing layer;

R is the calculated resistance of the soil under the lower end of the pile, Pa;

F is the cross-sectional area of the pile at its lower end, m^2 ;

$R_{Sh.n}$ is the calculated specific negative friction of the soil on the lateral surface of the pile, Pa.

The resistance to heave forces at the maximum depth of freezing is checked for the freezing period:

$$K\phi + u \sum_{i=1}^n f_{Ti} l_i \geq \tau u \xi_K^M, \quad (4)$$

f_{Ti} is the specific resistance of the unfrozen soil to shear on the lateral surface of the pile in the i -th layer, Pa;

τ is the specific tangential heave force in the freezing layer, Pa;

K is the bearing power utilisation factor.

If heave force resistance condition (4) is not observed, either the depth of pile embedment is increased or the period of freezing is reduced, with a corresponding reduction in the depth of freezing.

Special design or technological measures (for example, anti-heave coatings, protective casings, fills of materials without heaving properties) may be implemented to eliminate the adverse effect of the layer of freezing and thawing upon the stability and bearing capacity of the foundation.

The method of laying the engineering utility lines is of great importance in maintaining the reliability of buildings and structures erected using the method of permafrost stabilisation in the foundation. Experience shows that the thermal effect of utility line systems upon permafrost foundation soils is one of the main causes of deformations in buildings or structures. The stability of all engineering structures therefore depends to a large extent upon the system of laying utility lines.

In construction using the permafrost stabilisation method the main utility lines and the lead-ins and outlets in the buildings are laid either underground (in ducts giving complete or partial access ventilated with outside air) or above ground (in boxes and on trestles). The underground laying of engineering utility lines is based upon the same method of permafrost stabilisation, for which the duct ventilation conditions are specified to maintain an average air temperature in the duct which eliminates freezing and thawing of the soil outside its walls. Provision is made in the duct for the removal of possible emergency discharges from the buildings.

Utility lines within blocks of buildings are located on the service floors or in the ventilated air spaces of the buildings; unification of residential groups by the interlocking of buildings is used for this purpose during development. This also provides the opportunity for shielding the built-up areas from the prevailing wind and for creating a favourable microclimate to make the residents' life more comfortable.

Thus the flow of heat to the soil both from the buildings and from the utility lines is practically eliminated, ensuring reliable foundations. In addition, the access channels make it possible to reach the utility lines throughout their length; the probability of accidents is reduced to a minimum and reliability, convenience and economy in use are increased.

Let us give an example of the construction in recent years of a settlement for 6000 workers, using the permafrost stabilisation method. The settlement was made up of five-storey large-panel buildings interlocking with each other. The buildings were equipped with service floors and with air spaces ventilated with outside air (Figure 1).

Special air holes are provided in the base of the buildings to ventilate the air spaces; the size and number of holes are calculated on the basis of the necessity for maintaining a mean annual air temperature of 0°C in the air space. To eliminate the danger of blockage by snow, the holes are in the form of z-shaped channels in the walls of the service floor and the ventilated air space, the level of the outer opening being 2.5 m on average above the planning level. The holes are equipped with louvred gratings for opening and closing, to control the ventilation regime.

The territory of the settlement is an area of great variety and complexity as regards frozen ground. The permafrost table is at various depths (over 10 - 12 m in about 60% of the territory). There is extensive short-term permafrost to a depth of up to 6 - 7 m, occupying more than half of the entire territory. The upper part of the geological section (to a depth of 5 - 7 m) is represented by suglinoks, lower down (to 10 - 15 m) by sand and gravel soils, and also in individual cases by supes, suglinoks and clays.

Under these conditions, the permafrost table in the building foundation was levelled by preliminary thawing of the ground to a depth of up to 10 m from the day surface in individual sectors.

The foundations of the buildings were of driven ferroconcrete piles 30 x 30 cm in cross section and 6 - 8 m long sunk in unfrozen ground

with underlying permafrost. In these circumstances the lower ends of the piles were not less than 2 - 4 m above the permafrost table (depending upon soil type and condition). Construction was carried out without digging foundation pits for the buildings, with the pilework at the level of the rough marks or somewhat higher. As a preliminary, a fill of coarse material not less than 0.5 m thick was laid on the building sites on the undisturbed vegetation.

The main utilities were housed in a double-level ventilated duct, both levels giving full access (see Figure 1). The upper level carried the heating and the hot and cold water supply pipes, while the sewage system and the electrical system and telephone cables were laid in the lower level; provision was also made for the removal of possible emergency discharges. The main duct was connected to the group of interlocking buildings by a single-level access duct for joining the utilities to the building. All the systems within the blocks of buildings were housed in the building service floors; this became possible as a result of interlocking the buildings. Lawns 6 m wide with shrubs were laid around the perimeters of the buildings to reduce the depth of freezing under their edges.

Construction using the foundation permafrost stabilisation method has provided a capability for effecting major planning and technical indices. The length of outside sanitary and engineering utility lines was reduced by 4.5 times. The amount of preliminary thawing was reduced to a minimum, and construction time was reduced by half a year. This permitted considerable savings in capital expenditure and labour resources in building the settlement. Part of the settlement is shown in Figure 2.

Using the construction method with foundation permafrost stabilisation provides an opportunity for effecting substantial improvements in all the main technical and economic indices of construction, especially in sectors with complex frozen-ground conditions. This predetermines the possibility of making extensive use of the method in the frozen-ground conditions mentioned; as a rule these are typical of the southern zone of permafrost distribution, which has the greatest potential from the point of view of its rapid industrial development.

Figure 1

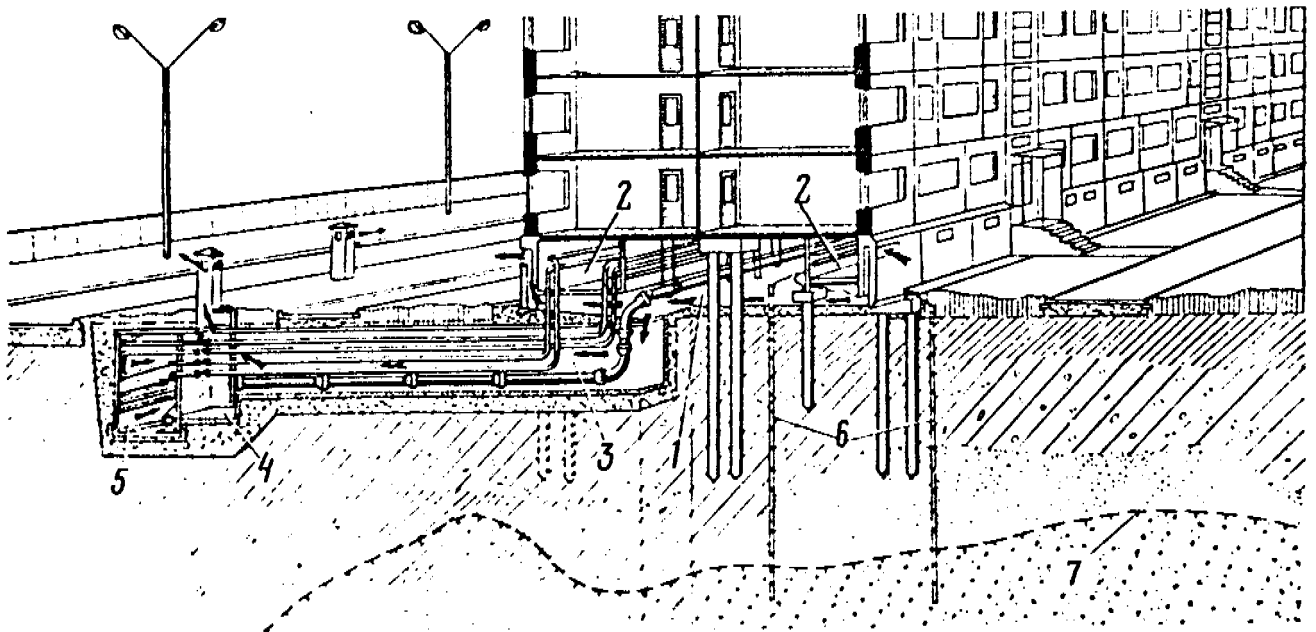

Design of residential building ensuring stabilisation of permafrost table.
1 - ventilated air space; 2 - duct with partial access for heat and water supply lines; 3 - single-level ventilated duct; 4 - ventilation well; 5 - double-level access duct; 6 - temperature boreholes; 7 - upper surface of permafrost.

Figure 2

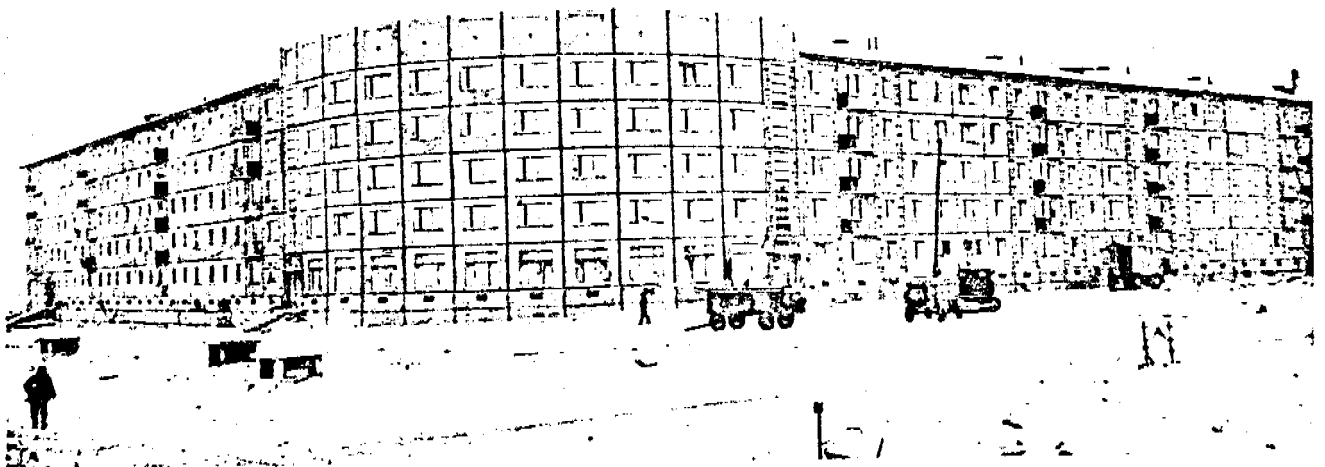

Part of the facade of the block of buildings.

REFERENCE

1. VYALOV, S.S. Principles of controlling the geocryological conditions during construction in the permafrost region. Second International Conference on Permafrost, Papers and Communications, Issue 8, Yakutsk, pp. 151-188, 1975.
2. EROSHENKO, V.N. Pile foundations in plastically frozen ground. Stroizdat, Leningrad, 210 pages, 1972.
3. ZHUKOV, V.F. and PONOMAREV, V.D. Artificial thawing of permafrost before construction. Second International Conference on Permafrost. Papers and communications, Issue 7, Yakutsk, pp. 57-62, 1973.
4. PORKHAEV, G.V. Thermal interaction of buildings and structures with permafrost. Moscow, Nauka Press, 208 pages, 1970.
5. KHRUSTALEV L.N. et al., Erection of buildings with stabilisation of the permafrost table, "Na Stroikakh Rossii", No. 1, 1967.

LONG-TERM SETTLEMENT OF FOUNDATIONS ON PERMAFROST

S.S. Vyalov

Research Institute of Foundations and Underground Structures,
Moscow, U.S.S.R.

Frozen and especially plastic frozen soils are capable of developing long-term creep settlement. To study this type of settlement, the author carried out field tests on model foundations constructed in plastic frozen soils and subjected to constant loads. The tests were started in the fifties in Igarka and lasted for 19 years. The experimental method and the results of accompanying experiments under laboratory conditions were described previously (Vyalov, 1959). The present paper contains the results for the entire period of testing and discusses the field and laboratory data obtained.

It was shown in laboratory tests (Vyalov, 1959) that settlement of frozen soils during a penetration test is a sum total of initial, conditionally instantaneous and progressive parts: $S = S_0 + S(t)$, all of which include a recoverable elastic component S^e and a non-recoverable plastic component S^p , so that total settlement is equal to $S = S^e + S^p$.

The recoverable part of settlement is the result of elastic compression of hard particles and ice, reversible displacement of particles and reversible phase transitions of ice to water at high pressure points. The non-recoverable part is due, on the one hand, to volumetric creep of the soil skeleton (displacement of particles along films of unfrozen water) and squeezing out (filtration) of unfrozen water replenished with ice melting at stress concentration points. This is accompanied by a change in the porosity of soil. On the other hand, non-recoverable deformation is the result of shear creep of frozen soil caused by non-reversible and progressive displacement of mineral particles along films of bound water and by ice flow.

These displacements disturb the structural bonds and lead to structural defects, such as micro- and macrocracks and other damages. In other words, they weaken the structure. On the other hand, displacement of particles, especially those related to volumetric compression, lead to a rearrangement and a more compact packing, elimination of defects and formation of new bonds, i.e., the structure is strengthened. If the strengthening effect predominates, settlement is attenuating. If weakening is the predominant effect, settlement is non-attenuating, which will with time lead to failure of the subsoil: a network of cracks will appear followed by regular settlement.

Settlement of frozen soils with time can be expressed with the help of the following equation of hereditary creep:

$$\frac{S}{d} = D \{ f[P(t)] + \int_0^t f[P(\xi)] Q(t-\xi) d\xi \}, \quad (1)$$

where D is a parameter characterizing the performance conditions of the subsoil under the local load; $f[P(t)]$ is a function of load; $Q(t - \xi)$ is a function (core) of creep; and ξ is an integration variable.

By analogy with the well-known Schleicher formula, which describes settlement of an elastic semispace, D may be taken (as confirmed by experiment) as $D = (1 - \nu^2)w$, where ν is the Poisson coefficient, and w is a coefficient which depends on the shape and flexibility of the plate. For a round (in plan view) rigid plate $w = 0.79$.

Function $f(P)$ can be taken as

$$f(P) = \left(\frac{P}{A} \right)^{1/m}, \quad (2)$$

where $m < 1$ and A are parameters. Let us assume that m is constant for a given soil, and is independent of temperature and time. The parameter A , however, is a function of the temperature of frozen soil which reflects the effect of the latter on the settlement:

$$A = A(\theta) = Q + b/\theta^\alpha, \quad (3)$$

where Q (Pa) is the value of A at $Q = 0$; θ is the temperature of frozen soil in $^{\circ}\text{C}$ without a minus sign; b ($^{\circ}\text{C}^{-1/m}$) and α are parameters and $\alpha = 0.5$.

The function of time $Q(t - \xi)$ can be written as follows:

$$Q(t - \xi) = \left[\frac{T_2}{T_1 + (t - \xi)} \right]^n \quad (4)$$

The form of equation (4) will depend on the values of T_1 , T_2 and n . At $n = 1$, $T_1 = T$ and $T_2 = \delta$, we have $Q(t - \xi) = \delta [T + (t - \xi)]$, which on substituting this expression into (1) leads to a logarithmic law of settlement. At $n = 2$, $T_1 = T$, $T_2 = [T(\delta - 1)]^{0.5}$, we have $Q(t - \xi) = T(\delta - 1) \times [T + (t - \xi)]^{-2}$, and from (1) we obtain a linear-fractional law. Finally, at $n = 1 - \beta$, $T_1 = 0$ and $T_2 = (\beta\delta/T^\beta)^{1/1-\beta}$ we obtain

$$Q(t - \xi) = \beta\delta T^{-\beta} (t - \xi)^{\beta-1}, \quad (5)$$

which yields an exponential law of settlement.

Equation (5) provides best agreement with experimental data. Substituting this expression (at $T = 1$) into (1) and taking $f(P)$ as it is given in equation (2), we obtain for a general case of variable load $P = P(t)$ and variable temperature $\theta = \theta(t)$ the following equation of settlement:

$$\frac{S}{d} = (1 - \nu^2) w \beta \delta \int_0^t \left\{ \frac{P(\xi)}{A[\theta(\xi)]} \right\}^{1/m} (t - \xi)^{\beta-1}, \quad (6)$$

where $A[\theta]$ is determined from equation (4) with allowances for the fact that θ varies with time.

If P and θ are constant, equation (6) assumes the following form:

$$\frac{S}{d} = (1 - \nu^2) w \left(\frac{P}{A} \right)^{1/m} (1 + \delta t \beta). \quad (7)$$

Equation (7) can be represented as follows:

$$\frac{S}{d} = (1 - \nu^2) w \frac{P}{E(P, t)}, \quad (8)$$

where $E(P, t)$ is a variable modulus of deformation equal to

$$E(P, t) = (AP^{m-1})^{1/m} (1 + \delta t \beta). \quad (9)$$

At $t = 0$, $E(P,t) = (AP^{m-1})^{1/m}$ and equation (7) defines the initial settlement

$$\frac{S}{d} = (1 - \nu^2)w(P/A)^{1/m} \quad (10)$$

At $m = 1$, the modulus $E(P,t)$ assumes the value of the modulus of linear deformation $E(P,t) = E = A$ and equation (10) is transformed to the Schleicher formula of settlement of linearly-deformed semispace:

$$\frac{S}{d} = (1 - \nu^2)w P/E. \quad (11)$$

Equation (10) reflects the so-called "accelerating" law of creep: settlement develops indefinitely but at a steadily decreasing rate. The validity of this law was confirmed by our penetration tests at the Igarka underground laboratory (Figures 1 and 2). Use was made of round (in plan view) plates. The experimental soils were undisturbed frozen supes, suglinok and dense clays whose temperature ranged from -0.4° to -7.6°C . The tests were carried out on slabs of soil enclosed (immured?) in the "floor" of the underground laboratory (using plates 50, 70 and 100 mm in diameter) or by pressing the plates (500 mm in diameter) directly into the "floor" composed of frozen clay.

Figure 1 shows the development of settlement of frozen soil under a constant load. Figure 2 illustrates the relationship between settlement and the load obtained from tests with step-like loading. The curves in Figures 2a and 2b were obtained in tests with different durations of loading steps and illustrate the changes in the modulus $E(P,t)$ with time. The curves in Figures 1a and 2a demonstrate the important role of creep settlement. For example, the settlement developed in 72 hours exceeded that developed in the course of a 30 min loading period by a factor of 8. If compared with the initial conditionally-instantaneous values, the long-term settlement is found to be several magnitudes greater.

Figure 2c illustrates the results of unloading after each loading stage, which made it possible to distinguish between recoverable and

Figure 1

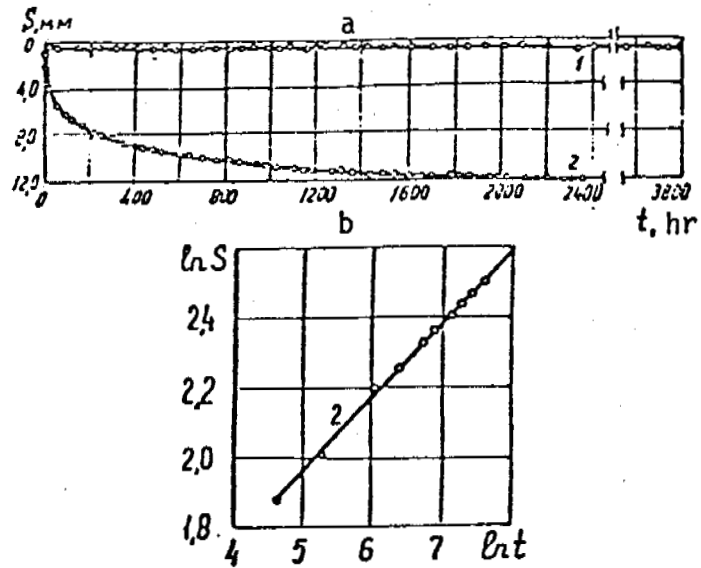

Development of settlement with time in conventional (a) and logarithmic (b) coordinates. Plate under constant load $P = 13 \times 10^5$ Pa in dense clay. θ : -7.6°C (1) and -0.4°C (2).

Figure 2

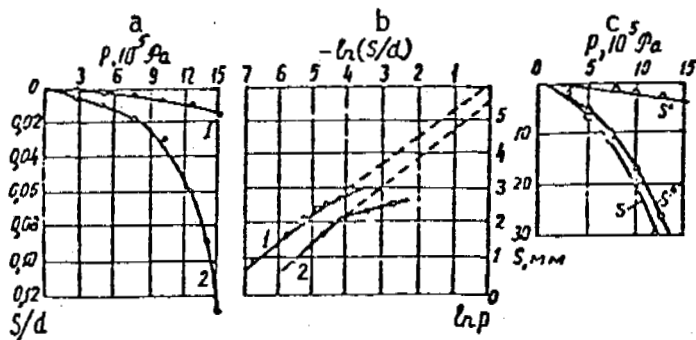

Settlement as a function of load.
 a - $S - P$ curves for various moments of time t :
 30 min (1), 72 hr (2);
 b - same in logarithmic coordinates;
 c - $S - P$ curves separated into the recoverable (S^e) and nonrecoverable (S^p) components.
 Plate ($d = 505$ mm) on dense clay ($\theta = -0.6^\circ\text{C}$).

nonrecoverable parts of settlement. We can see that nonreversible settlement is the predominant type. Consequently, equations (6) to (8) can be used to describe settlement under a constant or an increasing load. To describe the unloading process, allowance should be made for the separation of settlement into recoverable and nonrecoverable parts.

The validity of equation (7) is confirmed by the straightening out of the experimental $S - t$ and $S - P$ curves if these are plotted in logarithmic coordinates. Figures 1b and 2b show that the experimental points fall on the $\ln S - \ln t$ and $\ln S - \ln P$ straight lines, which confirms the validity of expressions (2) and (5) and hence of equation (7).

Let us note that the angle of slope of the $\ln S - \ln P$ straight lines for different durations of time (see Figure 2b) is about the same. This confirms the assumption that the parameter m is independent of time t . The values of m were found to be 0.5 - 0.6 for supes, 0.7 for suglinok and 0.8 - 0.9 for dense clay.

The parameter β is given by the angle of slope of the $\ln S - \ln t$ straight line (see Figure 1b). For dense frozen clay it is 0.21. Strictly speaking, β depends on the load, which is discussed in detail in our paper to be presented in Section 4 of this Conference. In this paper we derive a generalized equation of deformation of frozen soil based on the physical meaning of the process. However, in a small range of stresses, we can take $\beta = \text{const.}$ and in this case the deformation equation will assume the form of equation (7).

In the derivation of equations (6) and (7) it was also assumed that the Poisson coefficient ν was constant. This assumption has little effect on the calculation results, since even if we assume that ν does change (due to differences in the mechanisms of volumetric and shear deformation), e.g. within the range $0.3 \leq \nu \leq 0.5$, the value of $(1 - \nu^2)$ would merely change from 0.91 to 0.75. However, if it is desired to allow for these changes, the variable value $\nu(P, t)$ must be included in equation (6) under the integral sign.

On the whole, however, equations (6) and (7) describe the development of settlement of frozen soil sufficiently well within the range of stresses normally applied to subsoils. Let us note that the exponential law of deformation was checked for different types of deformation and was confirmed by other investigators, e.g. Ladanyi (1975).

In the case of large loads, the S - P curve has an inflection which is clearly visible in the logarithmic plot in Figure 2b. This inflection reflects the development of nonattenuating creep settlement and can be regarded as an indication that the load has reached the ultimate value P_S .

RESULTS OF FIELD TESTS

The long-term field tests were started in 1952 at the Igarka permafrost station and were continued for almost 20 years*. The tests consisted in pressing three rigid plates ($d = 705$ mm) into permafrost. The plates were installed at a depth of 2.95 m on top of a 2 m thick layer of supes with massive and fine-reticulate structure resting on a pebble bed 80 cm in thickness. Beneath the pebbles there was dense varved clay. The moisture and ice content of supes ranged from 20 to 30% (occasionally 35%). In a few places, where there were ice inclusions, it reached 50 - 60%. The depth of seasonal thawing at the locations of plates 2 and 3 was 1.5 m. Plate 1 was located on a section with discontinuous permafrost.

The load on each plate was transmitted by means of a powerful lever, the short end of which was anchored in permafrost. As anchors we used two 89 mm steel pipes with welded-on ragbolts and provided with anchor plates. The pipes were installed in 15 m boreholes and subsequently frozen in. The load on a plate was transmitted through a standpipe. To prevent the latter from adfreezing to the ground, it was provided with a casing filled with grease. Settlement of each plate was measured by means of three dial gauges, whose readings were checked by leveling. The data given in this paper are average values of three measurements.

* The author is grateful to A.M. Pchelintsev, former director of the station for his assistance.

The soil temperature was measured with the help of thermocouples in the plates and slow-reading thermometers mounted in the boreholes at depths of 0 - 0.5 - 1.0 - 1.5 - 2.75 m beneath the bottom of the plates.

The natural soil temperature at the level of the bottom of plate 1 was -0.1°C and -0.1° to -0.3°C beneath plates 2 and 3. The plates were installed at the end of summer and during installation the soil temperature rose to 0°C . However, it eventually returned to its original value and was maintained for a period of 9 to 10 years by insulating the ground surface with sawdust which was replaced every year.

After 9 years the amount of sawdust was reduced to determine the effect of changes in the thermal regime of soil on its settlement. This resulted in a gradual cooling of soil. After 17 years, sawdust was removed completely and the surface was cleared from snow, which led to a sharp drop in soil temperature.

The temperature regime of soil beneath the plates at a depth of 0.5 m was as follows.

	Plate 1	Plate 2	Plate 3
1953 - 1963	-0.1° to -0.2°C	-0.3° to -0.5°C	-0.4° to -0.6°C
1964 - 1968	-0.3° to -0.5°C	-0.5° to -0.7°C	-0.7° to -0.8°C
1969 - 1971	-1.0° to -1.5°C	-0.8° to -1.3°C	-1.3° to -3.3°C

We should note that the temperature at a depth of 2.75 m was almost the same as above (except the last 3 years).

The loads were applied in steps and then kept constant. The initial load on plate 1 was $P = 1.3 \times 10^5 \text{ Pa}$ ($10^5 \text{ Pa} = 1 \text{ kg/cm}^2$) which was later increased to $P = 2.5 \times 10^5 \text{ Pa}$. The load on plate 2 was $P = 1.25 - 2.5 - 3.75 \times 10^5 \text{ Pa}$. The load on plate 3 was $P = 1.1 - 2.0 - 3.0 - 4.0 \times 10^5 \text{ Pa}$. The last values of the loads were kept constant for the remainder of the test. The initial loads on plates 1 and 2 were applied until settlement was stabilized. The loads on plate 3 were applied for equal periods of time (48 hours).

The final loads were such as to approximately correspond to the ultimate long-term strength of subsoil beneath structures $P_s = P_\infty$. These values were determined in laboratory penetration tests by the method of N.A. Tsytovich (1973) and from the equation

$$P_\infty = 5,55 C_{eq} + \gamma h, \quad (12)$$

where C_{eq} is the equivalent cohesion, γ is the unit weight of frozen soil, h is the depth of the foundation. Experiments showed that for supes $P_\infty = 3.0 \times 10^5$ Pa at $\theta = -0.1^\circ$ to -0.2°C and $P_\infty = 5.0 \times 10^5$ Pa at $\theta = -0.5^\circ\text{C}$.

Settlement of all three plates in the first year of testing and changes in soil temperature beneath the plates are shown in Figure 3.

Figure 3

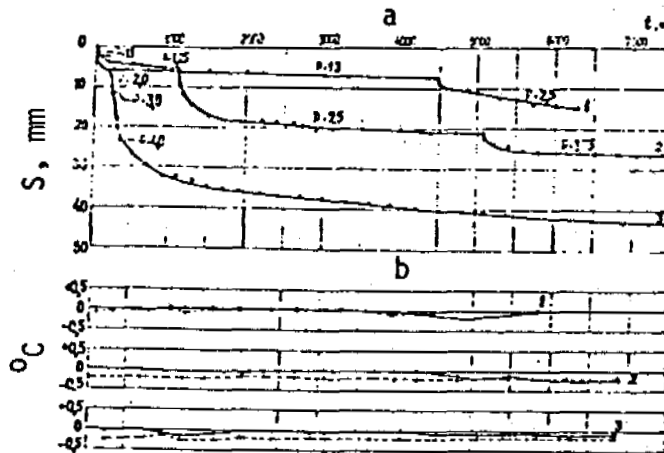

Settlement of plates 1, 2 and 3 in the first year of testing.

Load P , 10^5 (kg/cm²) increasing in steps.

a - development of settlement with time;

b - changes in soil temperature immediately beneath the plate (continuous line) and at a depth of 0.5 m (dotted line).

Let us first of all note the time of the increase in settlement even under small loads. For example, settlement of plate 1 under the initial load $P = 1.3 \times 10^5$ Pa was just 7 mm but stabilized only after 6 months.

Settlement of plate 2 under the loads of 1.25 and 2.5×10^5 was 5.5 mm and 21 mm and was stabilized after 1100 and 4000 hours respectively. The increase in the load to 3.75×10^5 Pa resulted in nonattenuating

settlement. Let us note that the increase in settlement at this loading stage was less than that at the preceding stage. It is possible that this was due to a slight drop in temperature beneath the plate (Figure 3b) or to some other unknown causes.

The load on plate 3 was applied in short stages, so that its final value of $P = 4.0 \times 10^5$ Pa was reached quickly. The plate was settling very rapidly, especially in the initial period, since the load $P = 4.0 \times 10^5$ Pa was applied when the soil temperature beneath the plate was 0°C .

The data in Figure 3 was used to plot the relationship between settlement and load (Figure 4a). The plot shows two curves. The upper curve was constructed from data on the increments in settlement during the 48-hour loading stages. The second curve was plotted from long-term loading stages of plates 1 and 2 (prior to stabilization of settlement); the last points on the curve at the highest loads correspond to settlement after 19 years of testing. The difference in the shape of curves illustrates the effect of the time factor (as in Figure 2a)

Figure 4

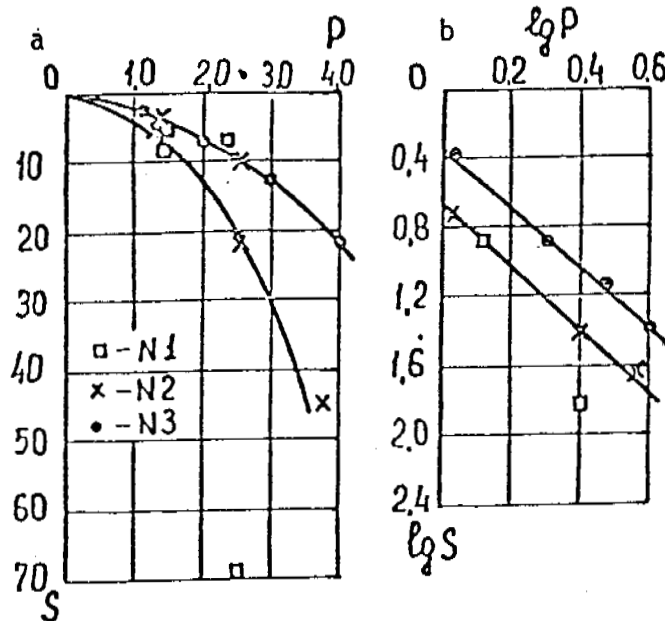

Settlement vs. load in conventional (a) and logarithmic (b) coordinates. Plates 1, 2 and 3.

Plotting the S - P curves in logarithmic coordinates (Figure 4b) produced straight lines which confirmed the applicability of the step function (2). We should note that the $\lg S - \lg P$ lines for different moments of time have the same angle of slope (as in Figure 2b). This confirms that the parameter m in formula (2) is independent of time. The value of this parameter was found to be 0.57 which is also in good agreement with values determined in laboratory tests.

Further settlement of experimental plates throughout the testing period is shown in Figure 5. The summary curves are given in Figure 6 together with changes in the mean annual temperature at a depth of 0.5 m beneath the plates.

Figure 5

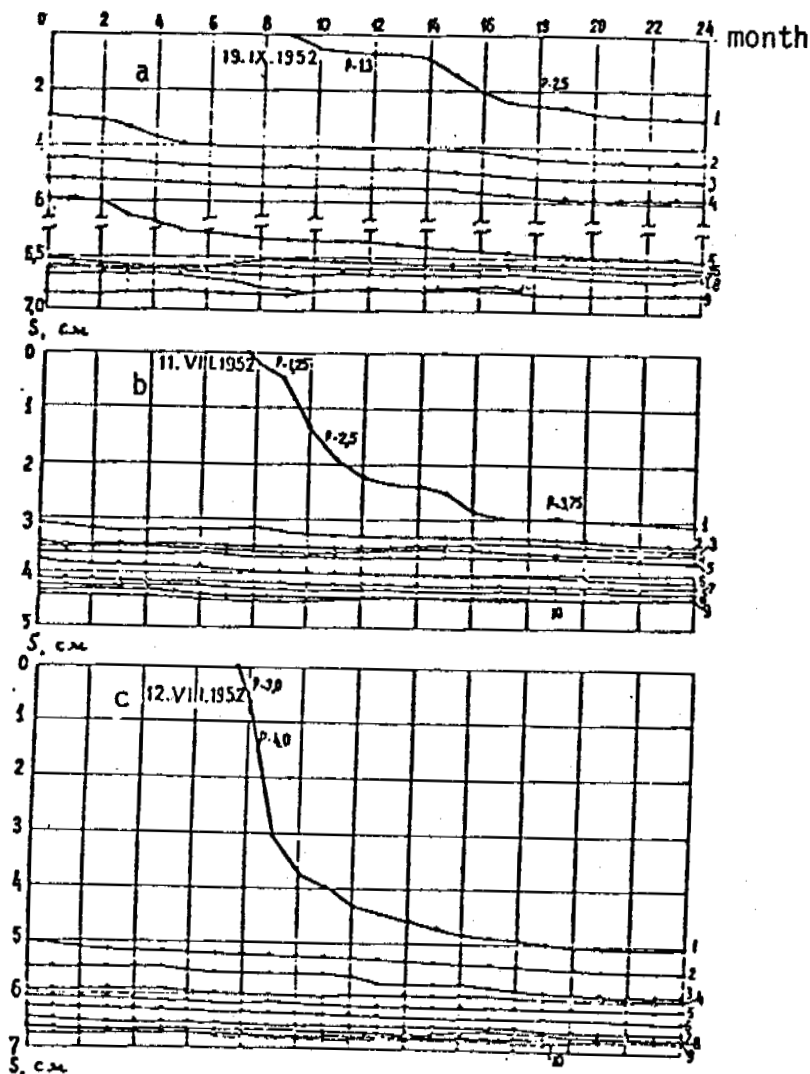

Settlement of plates 1(a), 2(b) and 3(c).

Dates

- 1 - 31.XII. 1953; 2 - 31.XII. 1955; 3 - 31.XII. 1957; 4 - 31.XII. 1959;
 5 - 31.XII. 1961; 6 - 31.XII. 1963; 7 - 31.XII. 1965; 8 - 31.XII. 1967;
 9 - 31.XII. 1969; 10 - 4.VIII. 1971.

Figure 6

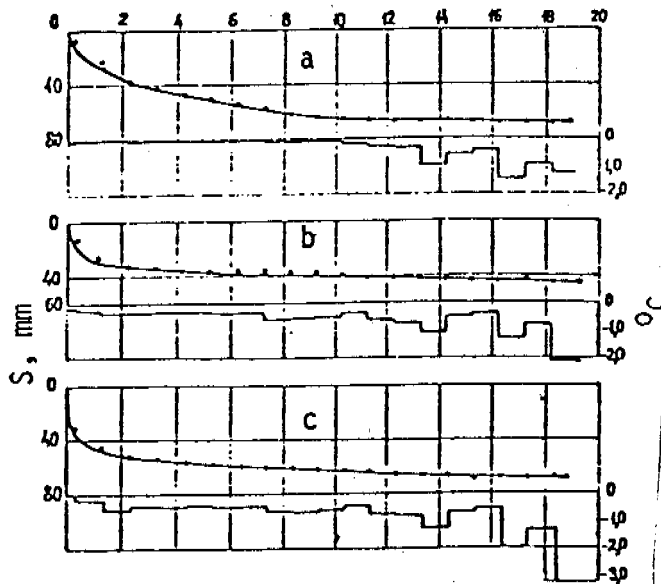

Summary diagram showing the settlement of plates 1 (a), 2 (b) and 3(c) and changes in soil temperature.

As may be seen from these diagrams, the development of settlement was continuous but at a steadily decreasing rate and stopped only when the soil temperature reached -1.5° to -2°C (in 1969). In fact, the plates were slightly uplifted due to heaving of frozen soil as its temperature was dropping.

The test was terminated in 1971.

When analyzing the curves illustrating the development of settlement with time it was found that the curve for plate 1 had an inflection corresponding to a time period of 9 - 10 years. The inflection was due to a change in the soil temperature. Settlement of plates 2 and 3 was affected by this temperature change to a lesser degree so that their $S - t$ curves remained sufficiently smooth. To determine the form of the settlement-load curves, we checked the applicability of the time function (4). Depending on the values of T_1 , T_2 and n , the settlement equation assumed (if the initial load was

ignored) a logarithmic form $S = \delta \ln(t + 1)$, or linear-fractional $S = \delta t / (T + t)$, or exponential

$$S = \delta t^\beta. \quad (13)$$

All three equations were found to be valid, although the exponential equation (13) agreed with the experiment best, and this was confirmed by the fact that the $S - t$ curves yielded distinct straight lines when plotted in logarithmic coordinates $\ln S - \ln t$.

The experiments yielded the following values of parameters in equation (13): for plate 2, $\delta = 2.725$ and $\beta = 0.167$; for plate 3, $\delta = 4.595$ and $\beta = 0.137$. As we can see, the values of β are very similar in both cases, which indicates that this parameter is stable and is practically independent of temperature and experimental conditions.

All the aforementioned factors affect the parameter δ . Hence the difference in its values from tests 2 and 3.

The $S - t$ curve for plate 1 can also be described by the exponential equation (13) but the parameters of this equation change their values at the inflection point on the curve ($t = 9$ years).

The theoretical curves calculated from equation (13) are shown as continuous lines in Figure 6.

In accordance with equations $S = (P/A)^{1/m}$ and $S = \delta t^\beta$ and using equation (7) as the base, we can rewrite the equation of settlement in the following form:

$$S/d = BP^{1/m} t^\beta \quad (14)$$

where $B = 0.79 (1 - \nu^2) A^{-1/m}$.

Taking the average experimental values we have" $m = 0.57$ and $\beta = 0.5 (0.137 + 0.167) = 0.152$. For this value of β , $\delta = 2.829$ for plate 2 and $\delta = 4.437$ for plate 3, and hence the parameter $B = \delta/dP^{1/m}$ will have the

values 3.98×10^{-3} and 5.58×10^{-3} for plates 2 and 3 respectively, or, on the average, $B = 4.78 \times 10^{-3}$ ($\text{Pa}^{-1}/\text{m}\cdot\text{year}^{-\beta}$), if t is given in years.

Let us now calculate the settlements from equation (14) using the values of parameters given above.

According to the latest edition of the U.S.S.R. construction rules and norms, pressure on frozen soil beneath a foundation depends on the ratio $P = mR/k_H$, where R is the design strength of soil, which for supes is taken as 3×10^5 Pa at $\theta = -0.3^\circ\text{C}$ and 5×10^5 Pa at $\theta = -0.5^\circ\text{C}$, while m and k_H are the coefficient of performance and the reliability factor equal to 1 and 1.2 respectively. If we take the average of the aforementioned values of R , the pressure on the soil will be $P = 4.0/1.2 = 3.3 \times 10^5$ Pa.

Substituting all these initial data into equation (14) we get:

$$S/d = 4.78 \times 10^5 \times 3.3^{1/0.57} t^{0.152}.$$

The settlements calculated from this formula are as follows:

<u>t, years</u>	<u>1</u>	<u>5</u>	<u>10</u>	
settlement, S/d	0.038	0.049	0.054	
<hr/>				
<u>t, years</u>	<u>17</u>	<u>25</u>	<u>50</u>	<u>100</u>
settlement, S/d	0.059	0.063	0.069	0.077

Thus, in the case of investigated soil (supes, $\theta = -0.3^\circ$ to -0.5°C), the settlement of a foundation, for example $F = 0.25 \times \pi \times 200^2 = 3.14 \times 10^4$ cm^2 in area, will be $S = 15$ cm in 100 years. This value is permissible for structures where differential settlement does not generate any additional forces. However, it exceeds the permissible values for certain other structures (large-panel buildings, etc.). The settlement can be greatly reduced by cooling the subsoil. There are several methods of cooling but this is beyond the scope of this paper.

Conclusions

1. Plastic frozen subsoil is capable of developing long-term creep settlement which may be considerable and must be allowed for when designing the foundations. Therefore, it is essential to design subgrade consisting of plastic frozen soil with respect to ultimate-permissible deformations, as stated in the Norms.

2. The pattern of settlement of plastic frozen soils with time can be described by the exponential law of "accelerating settlement" (7).

3. Cooling of plastic frozen soils noticeably reduces the rate of increase in settlement and may terminate the latter altogether. The settlement at temperatures which vary with time can be calculated from formula (6). The same formula can be used to allow for the variability of loads.

REFERENCES

- VYALOV, S.S. 1959. Rheological properties and the bearing strength of frozen soil. Moscow, Izd-vo AN SSSR, 190 pages.
- VYALOV, S.S. and TSYTOVICH, N.A. 1956. Calculation of the bearing strength of frozen soils from penetration tests with spherical stamps, Dokl. AN SSSR, vol. III, No. 6, pp. 1193-1196.
- TSYTOVICH, N.A. 1973. Mechanics of frozen ground. Moscow, "Vysshaya shkola", 446 pages.
- LADANYI, B. 1975. Bearing capacity of strip footings in frozen soils. Canadian Geotechn. Jour., Vol. 12, No. 3, pp. 393-407.

HYDRODYNAMIC AND HYDROCHEMICAL ASSESSMENT OF EXPLOSIONS
USED IN TESTING LOW-OUTPUT WELLS IN PERMAFROST REGIONS

V.M. Maksimov

Leningrad Mining Institute, U.S.S.R.

During prospecting for groundwater in water bearing levels composed of fissured magmatic, metamorphic, hard sedimentary and karstified rocks, including supraperafrost*, intrapermafrost and subpermafrost levels in permafrost regions, the wells in one and the same water bearing level often give a high output in some sectors whereas in others their output is low or they may even be practically dry.

This is due to changes in the nature of rock fissuring over their depth and extent; to the presence of disjunctive disturbances in some places which are absent from others, to the isolated nature of cracks and cavities in the same rocks and levels, to lack of uniformity in crack filling by secondary sand-clay formations, and to the sealing of open cracks and well walls by clay when drilling using clay based mud.

As numerous examples show, low output and practically dry wells yield abundant water and become suitable for water supply after detonating explosive charges in them or after torpedo drilling. Three interlinked zones are formed as a result of explosions in hard rocks which make up water bearing levels which have been penetrated for their entire thickness or opened up by the well to some depth or other: a crushing zone, a crack formation zone and a zone of elastic vibrations.

A number of formulas of reasonable scientific validity which have been tested sufficiently in practice are now being used for calculating the

* Supraperafrost water in nonfreezing taliks in fissured karstified rocks.

above named zones (Baum et al., 1975; Kutuzov et al., 1974; Pokrovskii, 1973). There is almost no published work especially devoted to the hydrodynamic and hydrochemical assessment of explosions in hydrogeological wells. This gave rise to the necessity for writing the present paper, which examines hydrodynamic and hydrochemical methods of assessing the detonation of explosive charges or special torpedoes in wells during hydrogeological testing.

The main purpose of detonating explosive charges or torpedoes in hydrogeological wells is to increase their output, by improvements in the filtration properties of the rocks at the bottom of the well due to the explosion. As many examples from various regions of the U.S.S.R. (including permafrost regions) show, the effect of explosions upon the output of wells when the geological and hydrogeological conditions for detonation are correctly assessed is extremely beneficial.

After the explosion the outputs of exploratory wells with a low flow rate and of operational wells which have lost output during their use increases by 1.5 - 16 or more times (Lovlya, 1971; Maksimov, 1952, 1974; Shlyaifert, Vol'nitskaya, 1970). The effectiveness of explosions in testing hydrogeological wells is assessed from the results of pumping operations before and after the explosion, using the same pump with the same reduction in water level and the same method of measuring the water flow rate. Hydrodynamic assessment of the effectiveness of explosions is by reference to the well output variation coefficient and the $Q = f(S)$, $S = f(t)$, and $S = f(\ln t)$ graphs. If the reduction in the water level in the well is the same, the well output variation coefficient is expressed by the following formulas (Maksimov, 1952, 1974, 1976):

$$n = \frac{Q_2}{Q_1}, \quad (1)$$
$$n = \frac{q_2}{q_1} \quad (2)$$

where Q_1 and Q_2 is the well output before and after the explosion, m^3/day ;

q_1 and q_2 is the well specific output before and after the explosion, $m^3/day.m$.

An analysis of the hydrodynamic effect of the explosion is given by reference to coefficient n . There are four possible cases:

- 1) $n = 0$, the explosion leading to a complete loss of output from the well; this is due to the unsuitability of the water-bearing rocks for explosion treatment (rock with a high content of clay particles and clay lenses and streaks);
- 2) $1 < n < 0$, the explosion leading to a negative result for the same reasons as in the first case;
- 3) $n = 1$, the explosion failing to yield the proper results for various reasons: explosive charge of insufficient size, poor flushing of the well prior to pumping, sealing of cracks with clay, etc.;
- 4) $n > 1$, an explosion with a positive result, confirming that the method of using it was correct.

In the first and second cases, repeated explosions either fail to give a positive result or yield a slight increase in well output; in the third case, repeated explosions often turn out well, with an increase in output to a level sufficient for the well to be used for water supply purposes.

Assessment of the effectiveness of explosions by reference to the $Q = f(S)$, $S = f(t)$ and $S = f(\ln t)$ graphs comes down to plotting these graphs on the same scale before and after the explosion and measurement on the Q , t , and $\ln t$ graphs at one and the same S .

When the explosion has a beneficial effect the curves plotted before and after the explosion occupy different positions on the graphs. The curves after the explosion, designated 2 in all the Figures, lie above the same curves before the explosion (1) (Figures 1, 2, 3 and 4).

Figure 1

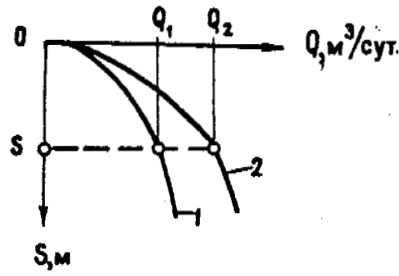

Unpressurized water-bearing level

Figure 2

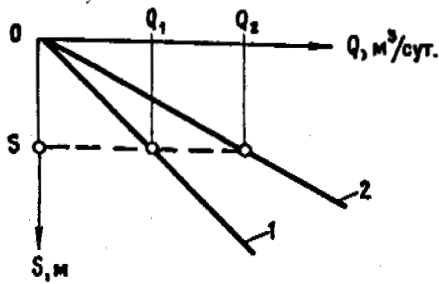

Pressurized water-bearing level

Figure 3

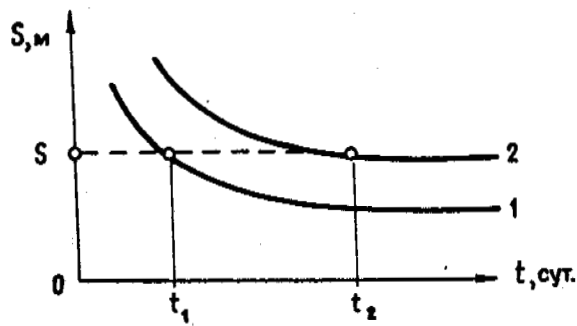

Restoration of water level in well $S = f(t)$

Figure 4

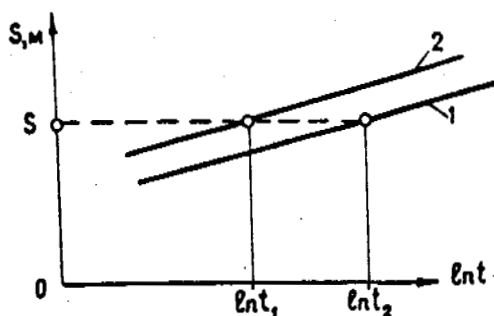

Logarithmic graph of level restoration $S = f(\ln t)$

It is most desirable to supplement the hydrodynamic assessment of the explosion by geophysical methods: electro-, photo-, and flowmeter logging before and after the explosion. When testing hydrogeological wells for supra-, intra-, and subpermafrost water recommended as a source of water supply, hydrochemical assessment of the consequences of the explosion is obligatory. This assessment is given by coefficients α , β , and ϕ , which define the changes in water mineralization and in its Cl, SO_4 , Ca and Mg content due to the explosion. The changes in mineralization are assessed according to the formula

$$\alpha = \frac{M_2}{M_1} \quad (3)$$

where M_1 is the water mineralization before the explosion, mg/litre;
 M_2 is the mineralization after the explosion, mg/litre.

The changes in the Cl, SO_4 , Ca, and Mg concentrations are assessed according to the following formulas*:

$$\beta_1^{Cl} = \frac{Cl_{ДВ}}{N_1} \quad (4) \quad \beta_2^{Cl} = \frac{Cl_{ПВ}}{N_1} \quad (5)$$

$$\beta_1^{SO_4} = \frac{SO_{4ДВ}}{N_2} \quad (6) \quad \beta_2^{SO_4} = \frac{SO_{4ПВ}}{N_2} \quad (7)$$

* The assessment can be carried out in a similar way for other elements in the water being studied.

$$\phi_1^{Ca} = \frac{Ca_{ДВ}}{N_3} \quad (8) \quad \phi_2^{Ca} = \frac{Ca_{ПВ}}{N_3} \quad (9)$$

$$\phi_1^{Mg} = \frac{Mg_{ДВ}}{N_4} \quad (10) \quad \phi_2^{Mg} = \frac{Mg_{ПВ}}{N_4} \quad (11)$$

where Cl_{pre-e} , SO_4_{pre-e} , Ca_{pre-e} , and Mg_{pre-e} is the pre-explosion concentration, mg/litre, mg-eq/litre;

Cl_{post-e} , SO_4_{post-e} , Ca_{post-e} , and Mg_{post-e} is the post-explosion concentration, mg/litre, mg-eq/litre;

N_1 , N_2 , N_3 , and N_4 are the All-Union State Standard (GOST) drinking-water norms for Cl , SO_4 , Ca , and Mg .

Assessment of the consequences of the explosion in terms of α , β , and ϕ is as follows. Where $\alpha = 1$ there has been no change in water mineralization in the water-bearing level tested; where $\alpha < 1$ the water has been demineralized by bringing surface or groundwater with lower levels of mineralization into the explosion zone; where $\alpha > 1$ the mineralization has increased. The latter is usually due to the inflow either of mineralized water from deep levels, or water from the upper soil layer, or saline water from lakes or seas caught by the explosion-affected zone.

Assessment by reference to β and ϕ is made in the same way. Where $\beta_2 = \beta_1$ and $\phi_2 = \phi_1$ the explosion has not affected the composition of the water; where $\beta_2 < \beta_1$ and $\phi_2 < \phi_1$ the quality of the water in terms of Cl , SO_4 , Ca , and Mg has altered by comparison with the GOST norms (an improvement in quality where $\beta_2 < \beta_1$, a deterioration where $\beta_2 > \beta_1$).

Surface polluted water and bog water, which lowered the quality of the groundwater recommended for water supply use in the water bearing level studied, was drawn into the explosion affected zone in particular regions during explosion testing of hydrogeological wells.

This explains the necessity and vital importance of bacterial assessment of underground water before and after the explosion; this

assessment can be made by reference to coefficient ψ , which reflects changes in the Coli titre of the water as a result of the explosion:

$$\psi = \frac{\text{Coli titre before explosion}}{\text{Coli titre according to GOST}} \quad (12)$$

$$\psi = \frac{\text{Coli titre after explosion}}{\text{Coli titre according to GOST}} \quad (13)$$

A comparison of ψ_1 and ψ_2 makes it possible to assess the degree of bacterial contamination of the groundwater which may occur in particular regions during explosion testing of hydrogeological wells.

Let us observe in conclusion that assessment of the hydrodynamic effect of an explosion, which we have carried out in many wells including wells in permafrost regions, by reference to a coefficient and to graphs under conditions of steady filtration gives a reliable picture of changes in the filtration process in the explosion affected zone.

Methods of assessing the hydrodynamic effect of an explosion have been adopted in practice for testing exploratory wells and operational wells where output has fallen for some reason or other (silting-up of filters, complete destruction of filters, reductions in the cross section of the main water-bearing cracks in the bottom zone of the wells when there are large reductions in the level in them, etc.).

The methods of assessing the hydrodynamic effect of an explosion considered in the paper are also applicable to unsteady filtration, which occurs in the first period of time in pumping operations, at the start of pumping; however, the piezometric levels and permeability of the earth materials before and after the explosion must be known to determine well output.

Hydrochemical and bacterial assessment of explosions for testing hydrogeological wells drilled for supra-, intra-, and subpermafrost water must always accompany hydrodynamic assessment.

The methods of assessing explosions in wells which have been considered form part of a new line of research being developed by the author in hydrogeology and the dynamics of underground water, including the hydrogeology of the permafrost region.

REFERENCE

1. BAUM, F.A., ORLENKO, L.P. and STANYUKOVICH, K.P. et al., Physics of explosion, Moscow, Nauka Press, 704 pages, 1975.
2. KUTUZOV, B.N., VALUKHIN, Yu.K. and DAVYDOV, S.A. et al., The planning of blasting work, Moscow, Nedra Press, 328 pages, 1974.
3. LOVLYA, S.A. Blasting in water wells, Moscow, Nedra Press, 120 pages, 1971.
4. MAKSIMOV, V.M. Torpedoing of hydrogeological wells to increase the water flow, Zapiski Leningradskogo Gosudarstvennogo Universiteta, Vol. 27, Issue 2, pp. 247-263, 1952.
5. MAKSIMOV, V.M. Hydrogeological calculations for wells in an explosion-affected zone, Ibid., Vol. 67, Issue 2, pp. 162-173, 1974.
6. MAKSIMOV, V.M. Methods of assessing the hydrodynamic effect of explosions in wells, in: Physical processes in mining production, Issue 3, Leningrad, pp. 104-108, 1976.
7. POKROVSKII, G.I. Explosion, Moscow, Nedra Press, 182 pages, 1973.
8. SHLYAIFERT, M.A. and VOL'NITSKAYA, E.M. Increasing the flow from water wells, Moscow, Nedra Press, 63 pages, 1970.

THE STABILITY OF UNDERGROUND WORKINGS IN PERMAFROST

E.A. El'chaninov, A.I. Shor and M.A. Rozenbaum
Mining Institute, Moscow, U.S.S.R.

A comprehensive study of the connection between production processes and physical phenomena in the rock mass is vital to further improvements in production and essential for forecasting the mining situation.

The physical and mechanical properties of fissured frozen rock are closely linked with the rock temperature, especially when moisture content and fissuring are at high levels. The process of heat generation and dissipation in the frozen rock mass therefore leaves an imprint upon the behaviour of the rock in the process of deformation itself and upon its final state.

The shaping of temperature conditions in a rock mass untouched by mining is usually linked with the geographical position of the region, the climate, the configuration of the ground water bodies, the proximity of bodies, the hydrogeology of the deposit, and the depth at which the rock occurs. Changes in rock temperature by comparison with the temperature of the untouched mass in the zone of extraction and preparatory work used to be regarded as due to heat and mass exchange with the air flowing through the workings, to the reaction of the rock with the working parts of mining and shaft-sinking machines and to drilling and shot-firing work. The effect of oxidising processes and liberation of gas was also taken into account.

Until recently, however, no study has been made and no account taken of the fact that heat is released and dissipated due to irreversible deformations of a rheological nature in the mass in which the state of

equilibrium is being disturbed by workings. During mining work, substantial volumes and enormous mass forces participate in the deformation processes. As early as 1933 Academician A.A. Skochinskii pointed out the necessity for taking account of changes in rock mass temperature resulting from rock subsidence.

When driving mine workings, the displacement of elementary volumes of the mass due to redistribution of its state of stress and deformation begins ahead of the working face. The volumes in the zone near the working face undergo the greatest shifts and deformations during equal intervals of time. The shift and deformation rates decrease as the distance from the face increases, dying out at a specific distance from it. The whole shift zone travels with the advance of the face, passing consecutively through each point in this zone; as a result, all points in the zone go through the complete cycle of stress- and deformation- and consequently temperature disturbances.

The actual state of a point depends upon its position relative to the face and to the wall of the workings.

Heat is dissipated from the preceding disturbance in accordance with the rate of advance of the face between successive changes in the state of the point; the disturbances pass through either separately or as accumulations. Some of the heat dissipates in the mass and some is transmitted to the air flow from the walls of the workings, depending upon the sign of the temperature drop. Thus changes in the temperature of an elementary volume of the mass in a zone in which its state of stress and deformation changes depend upon the distance to the face, remoteness from the wall of the workings and the intensity of the displacements. All these characteristics may be included as boundary conditions in an analytical solution of the associated problem.

The laws of thermodynamics can be used to establish the link between deformation and temperature. The macroscopic theory of irreversible processes, developed in recent years, makes it possible to formulate the problem of an irreversible deformation process on the basis of a

thermodynamic approach to the derivation of relationships between stresses and deformations which contain temperature terms. These problems have been solved by A.D. Kovalenko for conditions of metal deformation on the assumption that the process is adiabatic and the density of entropy remains constant. Within the framework of the thermodynamics of linear irreversible processes he gives the derivation of an equation of unsteady thermal conductivity with a term dependent upon deformation (Kovalenko, 1968). The system of equations obtained describes an "associated" problem, in which the temperature field and the deformation field are regarded as interlinked.

Formulation of the associated problem for determining the changes in rock temperature caused by mining pressure in the underground working of deposits consists in the need for determining 16 functions of coordinates x_k and time t , given preassigned mechanical and thermal effects: six deformation tensor components, six stress tensor components, three movement tensor components, and the temperature, satisfying three motion equations, six relationships between stresses and deformations, six relationships between deformations and movements, and the thermal conductivity equation, for specific initial and boundary conditions reflecting the law of stress and deformation distribution in the zone of abutment pressure, the law of cyclic changes in the state of the rock, changes in the thermophysical characteristics of the rock caused by changes in its state of stress and deformation, and changes in the density of the heat flux in a mass disrupted by cavities of substantial volume.

Analytical solution of such a problem clearly involves considerable mathematical difficulties; we therefore carried out in situ mine observations to study the nature of changes in the surrounding rock temperature due to mining pressure under natural conditions.

The rate of chemical processes in frozen rock is negligible while a negative temperature is maintained; in addition, there is no methane in the frozen mass as a rule. The observations were made in workings insulated from the effect of seasonal fluctuations in air temperature. These circumstances made it possible to assess the changes in rock temperature during the course of deformation during mining.

The investigations consisted of recording the temperature of the wall rocks at various distances from the walls of the workings and the convergence of the roof and footwall rocks. The magnitude and speed of convergence of the roof and footwall rocks of the workings were adopted as the index of rock deformation.

The measuring stations were located at the face in preparatory workings, in workings adjacent to the cutting faces, and in workings separated from them by pillars. The workings where the measuring stations were located had the following characteristics: cross-sections from 6 to 12 m², density of timbering from 0 (without timbering) to 1.5 supports per metre, the footwall and roof of the workings were composed of argillites, siltstones, sandstones, and coals of various structures, the natural temperature of the mass in the various workings was from 0.2°C to -6°C, and the depth of occurrence was in the 60 - 180 m range. The nature of the changes in wall rock temperature in the zone of intense deformations in the mass remained the same in spite of the diversity of the mining conditions. The maximum increase in temperature corresponded to the maximum deformation rates. In the zone affected by cutting, deformation of the rock and a rise in its temperature away from the walls of workings insulated from heat exchange with the air flow began simultaneously at a distance of 25 - 45 m in front of the face. The maximum changes were observed at a distance of up to 6 m in the vicinity of the longwall. The rock temperature was restored to its initial level at a distance of 35 - 70 m behind the longwall. In the conditions studied, in the vicinity of the cutting face line in the "Beringovskaya", "Anadyrskaya", and "Dzhebariki-Khai" mines, the rise in rock mass temperature at a maximum speed of roof and footwall rock convergence of up to 30 mm/day by the period of main roof caving (40th - 45th extraction cycle) was 2.29°C relative to the natural temperature of the mass (Figure 1).

When driving preparatory workings, the rate of convergence and the temperature of the rock diminish as the distance from the measuring station to the face increases. Under the conditions studied, the changes in temperature and the convergence of the rocks ceased simultaneously at a distance of 10 - 17 m from the face. The convergence rate and temperature peaks in the wall rocks coincide irrespective of the distance to the wall of

Figure 1

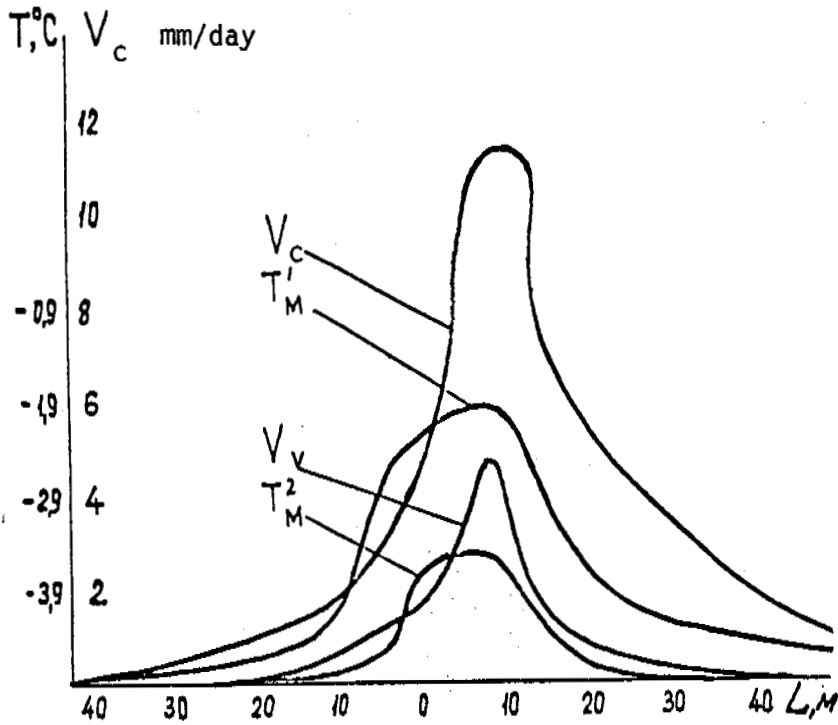

Changes in coal mass temperature and in rock convergence in the vicinity of face workings. L is the distance to the cutting face line; V_C and V_V is the rate of convergence of the rocks in the airway and conveyor drift, mm/day; T_M^1 and T_M^2 is the temperature of the rock mass round the conveyor drift and the airway, $^{\circ}\text{C}$.

the workings. The maximum rise in temperature under the conditions studied, at a depth of 0.2 m from the wall of the workings with a speed of face advance of 10 - 12 m/day and a speed of rock convergence on the face line of 5 - 6 mm/hr, was 0.6 - 0.9 $^{\circ}\text{C}$ (Figure 2). When the results were analysed, the high correlation coefficients confirmed the existence of a close relationship between the temperature of the rocks and the magnitude and rate of their deformation.

When the rock temperature rises, even within the range of negative values, its strength is reduced and its plastic properties become more clearly defined. Consequently, in view of the non-uniform stress state in the frozen mass, the heat liberated in the course of rock deformation when driving mine workings causes temporary weakening of the ice-cement bonds and

contributes to rapid redistribution of internal stresses. Subsequent cooling of the rocks causes the partial restoration of the old ice-cement bonds and the formation of new bonds in conformity with the stabilized temperature. Restoring the temperature of frozen rock as the stresses in it are redistributed and as distance from the zone of intensive displacements increases therefore stabilizes and preserves the workings when they are kept at negative temperatures. When organising temperature conditions in a mine, efforts must be made to keep the rock surrounding the workings frozen in addition to creating an air temperature above zero at the cutting face.

Figure 2

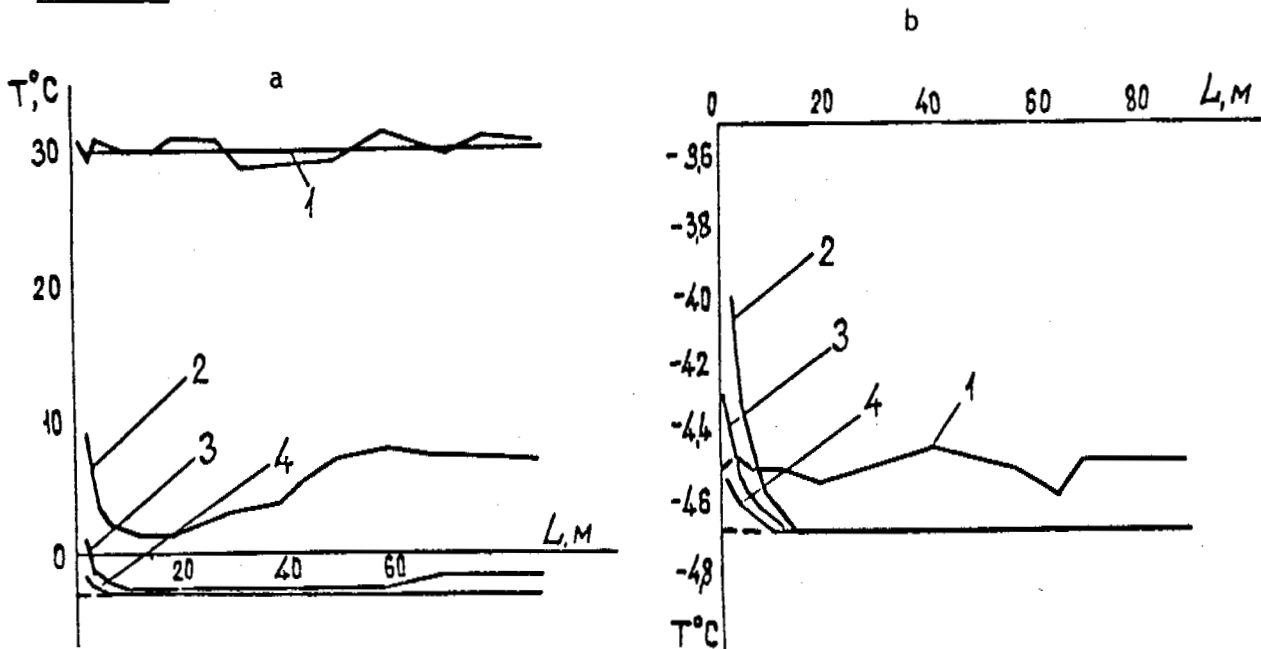

Changes in temperature of air and surrounding rock mass ($^\circ\text{C}$) according to distance to the face of preparatory workings. a) - station No. 1, $T > 1$; b) - station No. 2, $T < 1$; T is the rock temperature, L is the distance to the face, curve 1 is the air temperature, curves 2, 3, and 4 are the rock temperatures at depths of 0.2, 1.0 and 1.8 m from the wall of the workings.

This can be done by establishing local above-zero temperatures in the requisite zones and through the use of insulating materials and other methods to protect the frozen rock from the effects of heat.

The frozen state of the rock and the severe climate with wide seasonal fluctuations in air temperature are decisive features in mining coal

deposits in permafrost. The frozen state of the rock predetermines the close dependence of its strength and deformation properties on the temperature, especially when there is a high moisture content and fissuring. It follows that the stability of the workings is dependent on their temperature conditions.

Keeping the rock in a stable condition and maintaining a low oxidising process rate call for the maintenance of sub-zero temperatures in the workings. Maintaining normal operating conditions for mechanised units, pipework for fire-fighting, and starting equipment, and above all, improving provisions for dust suppression and creating acceptable working conditions for the miners call for booster heating of the air. The booster heating of ventilating air with central stoves used in the Noril'sk mines led to thawing of the rocks and to loss of stability in the workings. The installation and operation of the central stoves, the heavy consumption of electric power, and the necessity for reinforced timbering in all the mine workings led to a sharp increase in the prime cost of coal. The additional outlay amounted to 1.09 - 1.4 rubles per ton mined. In addition, practical experience showed booster heating to be the cause of endogenous fires. Thus the requirements imposed upon temperature conditions in mines operating under permafrost conditions are contradictory. The development of efficient temperature control systems in these mines is therefore unthinkable without taking account of all aspects of the effect of air and rock temperature upon working conditions and the efficiency of production processes, and also the connection between the stability of the workings and the temperature of the surrounding rocks, and making the greatest possible allowance for factors which cause their temperatures to change. Work is in progress at the A.A. Skochinskii Institute of Mining with a view to finding effective ways of regulating temperature conditions in mines and determining suitable parameters for them.

We opted for maximum utilisation of the natural conditions and the elements of the production system itself to control the temperature conditions.

Figure 3

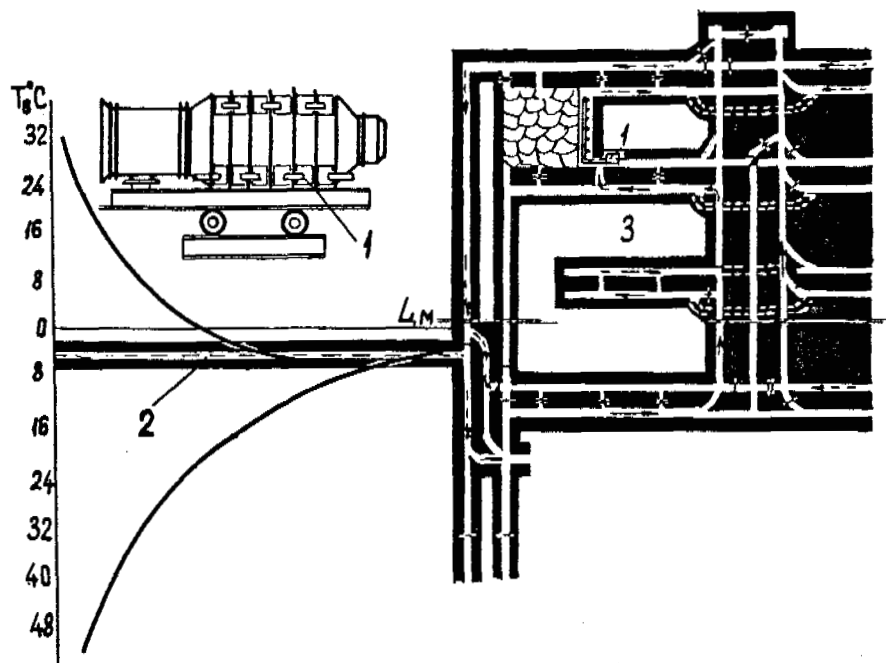

Schematic diagram of mine temperature control.
1 - installation for local booster heating of air;
2 - heat-storing workings; 3 - extraction sector.

For example, a combined system has been proposed for controlling the air temperature in a mine which simultaneously meets a number of contradictory requirements. The system consists of a combination of heat-storing workings* with local booster heating facilities (Figure 3). The method of using the heat-storing workings is as follows: the ventilating air passes through special workings and exchanges heat with the surrounding rock mass, acquiring a temperature close to that of the mass. This method utilises the reserves of heat (cold) in the mass to neutralise the effect of seasonal fluctuations in air temperature, while local booster heating, in contrast to general mine heating, makes it possible to protect all the airways from the effects of heat. Thus the system permits maximum utilisation of the advantages of natural permafrost conditions (the high stability of the frozen rock and the reserves of heat in the mass) even when

* Heat-storing workings - refers to special tunnels through which air is circulated to be conditioned. The mass of material surrounding the tunnel acts as a "heat sink" extracting heat from the air when the air is warmer and conversely adding heat when the air is colder. (Tech. Ed.).

temperatures above zero are created in the face workings. The fundamentals of the method of using heat-exchange workings were worked out at the Institute of Technical and Theoretical Physics, Academy of Sciences of the Ukrainian SSR, and the Leningrad Mining Institute. However, the method of controlling temperature conditions by using heat-storing workings has been recognised as the most economical only for mines with a low ventilating air flow rate (up to $Q = 1200 \text{ m}^3/\text{min}$). This is because of the sharp increase in expenditures in overcoming the aerodynamic resistance of the circuit in these workings (proportional to Q^3) at high air flow rates.

To eliminate the restrictions with respect to permissible temperature depression which limit the range of application of heat-storing workings, an analysis has been made of the factors which have the greatest effect upon the efficiency of the method. Among the controllable factors these proved to be the cross-sections of the workings, the air flow rate, and the degree of branching of the air flow. An analysis was made of the effect of these factors upon the length of workings necessary to reach a preassigned temperature. It was based upon a method of calculating the temperature conditions in the mines of the North which was developed at the Leningrad Mining Institute. The analysis showed that with an increase in the ventilating air flow rate from 500 to 4000 m^3/min the necessary length of the workings increased from 340 m to 5 km with a cross-section of 4 m^2 and from 500 m to 7 km with a cross-section of 15 m^2 .

The calculations were applied to conditions in the "Dzhebariki-Khai" deposit for a workings service life of 5 years. The conditions adopted were: temperature of surrounding mass -4.7°C , rock moisture content 8 - 11%, coefficient of thermal conductivity of rock $1.9 \text{ kcal}/\text{m}^2 \cdot \text{hr} \cdot \text{deg}$, weight by volume of rock $2.5 \text{ tons}/\text{m}^3$, seasonal fluctuations in air temperature from -60° to $+35^\circ\text{C}$, and final temperature of ventilating air in heat-storing workings -6°C .

A variable factor K which defines the relationship of necessary length L to air flow rate Q was calculated. This was done in order to simplify the thermophysical calculations which are needed to find the necessary length of heat-storing workings with various amounts of air passing through them:

$$\frac{L_2}{L_1} = \frac{Q_2}{Q_1} K = nK, \text{ then } L_1 = \frac{L_2}{Kn}$$

This factor gives an opportunity for substantial simplification of calculations in engineering practice, because all the indices to be taken into account and the restrictions which characterize actual mining conditions are correlated in it in implicit form. The value of K can be satisfactorily approximated by an expression in the form

$$K = A - \frac{B}{n} \text{ where } 1 < n < 6,$$

where A and B are constants in the equation.

For conditions in the "Dzhebariki-Khai" deposit $A = 1.79$, $B = 0.79$ and $n = 0.93$.

The branching of the ventilating air into n streams leads to a reduction of n times in the amount of air passing along each of the branches and the necessary length of each branch is reduced accordingly. Research on the effect of the degree of branching upon the necessary length of heat-storing workings has shown that branching involves a reduction in the total length of the circuit of "K" times and in the length of each of the branches of "Kn" times (where n is the number of branches and consequently the index of the reduction in the air flow rate in each of the branches compared with a single airway), and the aerodynamic resistance of the branched circuit is reduced by "Kn³" times.

In the conditions studied, branching of ventilating air into 2, 3 and 4 flows led to a reduction in the total length of the heat-storing workings of 1.39, 1.44 and 1.59 times respectively and to a reduction in the length of each of the branches compared with a single airway of 2.8, 4.4 and 6.4 times. In these circumstances the aerodynamic resistance of the branched circuit is reduced by 10.5, 39 and 101 times respectively.

Thus the restriction on the range of application of the heat-storing workings method in terms of admissible depression is removed. The factor also makes it possible to define the number of branches giving the

necessary heating effect for a prescribed temperature depression. The condition for defining the necessary number of branches to give the depression norm allocated to the heat-storing workings takes the form

$$n \geq \sqrt[3]{\frac{h_0}{h_{adm} K}}$$

where h_{adm} is the depression norm for the heat-storing workings and h_0 is the depression for a single working.

The next step in improving the method of control was to develop a system in which the reserves of heat (cold) in the outgoing ventilating air flow are utilised and the rock mass operates as an intermediate heat store. Intensification of the heat exchange process in this scheme, with a consequent reduction in the total length, is achieved by periodic changes in the direction of air movement according to a calculated schedule in special workings, the direction of movement of ventilating air in the whole mine ventilation circuit remaining unaltered (meeting the requirements of the safety regulations). The latter situation is maintained by the presence of a cross-over which is actuated when the next change occurs in the direction of flow in the heat-exchange workings and by the position of the ventilating doors (Figure 4).

The outgoing ventilating air periodically heats (cools) the rock mass surrounding the workings until its natural temperature is restored after the next cooling (heating) occurs in the course of heat exchange with the air that had come in during the previous period.

In addition, an inherent advantage in these systems is that the moisture automatically freezes on the walls when there is a regular cycle of flow reversal at the ends of workings adjacent to the main airway and the haulage drift; this promotes air cleaning by crystallisation and the consistent flow of moisture into the face workings, and this in turn reduces the dust level in the atmosphere in them. Since the drop in the temperatures of the outgoing ventilation flow and the outside air is reduced, the rate of icing on the flaps and gates of the main fan installations also decreases.

Figure 4

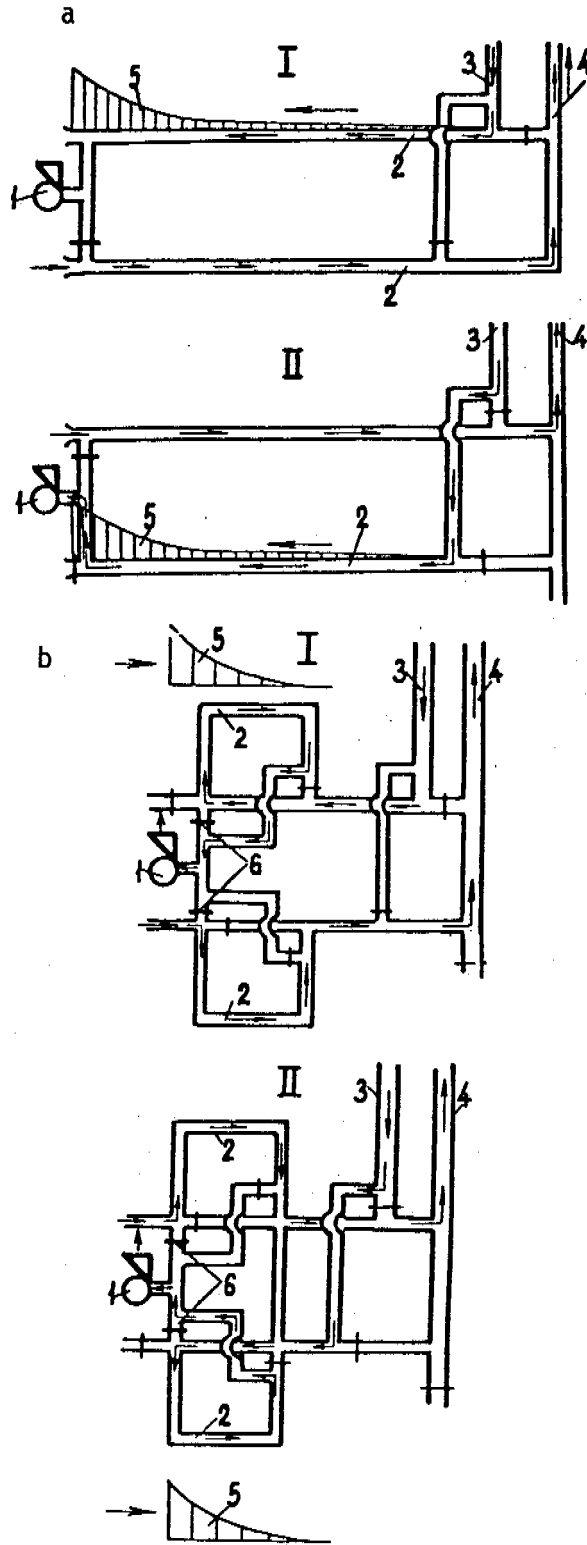

Basic operational systems of recuperative heat-storing workings.

a) - system 1; b) - system 2; I - first period of cycle; II - second period of cycle; 1 - main fan; 2 - heat-storing workings; 3 - main airway; 4 - main haulage drift; 5 - thawing (freezing) halos; 6 - automatic ventilation doors.

To improve efficiency in the use of mine workings as heat exchangers we provided for the installation in them of special temperature-regulating supports working on the heat pipe principle. In systems using the outgoing ventilation flow (recuperative systems), provision is made for the transmission of heat energy from the outgoing to the incoming flow by batteries of heat pipes. Finally the technical and economic efficiency of using all the systems is quite obvious when the heat-exchange workings are so placed that they could be used as preparatory workings as the mine develops (Figure 5).

Figure 5

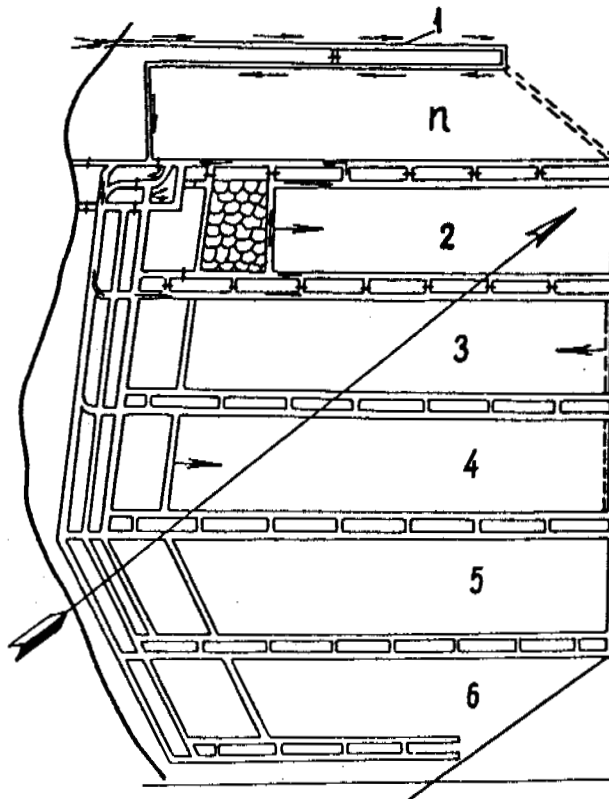

Working diagram of part of mine area.
1 - heat-storing workings; 2,3 ..., n - extraction sectors.

The specific purpose and conditions of work called for the development of a method of determining the optimum parameters of heat-storing workings. A method has been developed which involves seeking the minimum total adjusted expenditure on shaft sinking, supports and the maintenance and ventilation of such workings (Figure 6). Its distinctive characteristics are

Figure 6

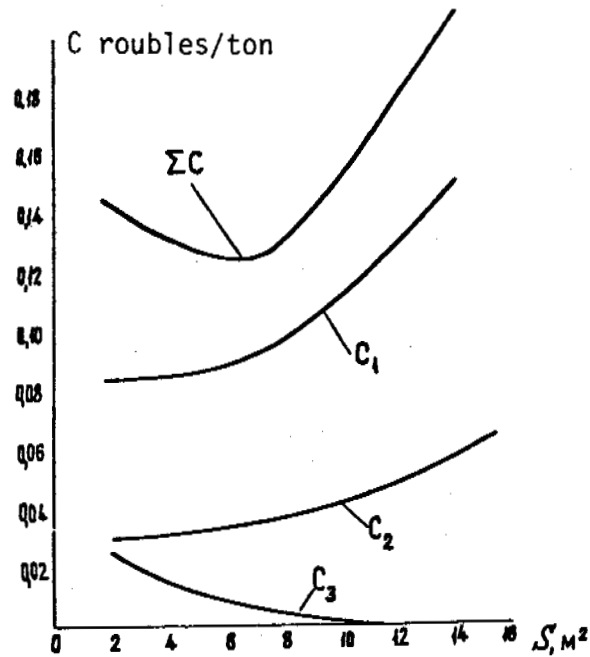

Choosing an efficient cross-section for heat-storing workings S is the cross-sectional area of the workings; C_1 , C_2 , C_3 and ΣC are the adjusted expenditures on ventilation, shaft sinking, maintenance and the total adjusted expenditures.

as follows. The length of workings necessary to achieve the prescribed temperature depends upon the cross-sectional area in such a way that the necessary length increases when the cross-section of the workings increases. The expenditures on shaft sinking, maintenance and overcoming aerodynamic resistance therefore depend both upon the cross-sectional area of these workings and upon the length which corresponds to this cross-section.

In addition, expenditure on maintenance is nonlinearly dependent upon the cross-sectional area of the workings, because the depths of the thawing zone affect the loading of the supports and consequently the cost of maintenance. Finally, expenditure on maintenance is not constant over the length of the workings, since the depths of the thawing zone alter along the length of the ventilation route.

These fundamental principles formed the basis of the optimization estimates. The adjusted expenditures $C + E_k$ were adopted as the target

function. The following limitations were imposed upon the variables studied: cross-section from 4 to 15 m², air flow rate 1200 m³/min, rock temperature -4.7°C, seasonal fluctuations in temperature from -60 to +35°C, and final temperature of ventilating air in heat-storing workings -6°C. Minimizing the target function made it possible to define the optimum parameters of heat-storing workings for the given conditions: cross-sections S = 4.7 m² and length L_{heated} = 1150 m, reducing them from S = 8.5 m² and L = 1400 m respectively.

Using efficient parameters for the heat-storing workings which have been incorporated in the mine area preparation system gives an annual saving of 118,000 rubles for the Yakutugol' Group "Dzhebariki-Khai" mine alone. The saving will exceed 220,000 rubles per year when these workings are used as preparatory workings once the mine develops.

Local booster heating of the air may be one method of protecting the workings of an entire mine operating in permafrost from the effects of heat. As has been demonstrated above, it is essential when defining the limits of booster heating of ventilating air to be fed to the longwall to allow for the fact that the rock temperature alters due to intensive changes in the state of stress and deformation in the mass. The thermophysical characteristics of the rock also alter in the deformation zone. This change in the physical state of the mass (and consequently in the conditions of heat exchange) can be taken into account in engineering practice by the coefficient of unsteady heat exchange k_r , which is determined by Academician Sherban's well-known formulas (Sherban', Kremnev, 1959) on the basis of in situ studies with allowance for the change in rock temperature found by us in the zone of abutment pressure:

$$k_r = \frac{\lambda}{T_r - t_v} \frac{dT}{dR} \text{ for } R \rightarrow R_0,$$

$$k_r = a \frac{T_w - t_v}{T_r - t_v} \text{ for } R = R_0,$$

where k_r is the coefficient of unsteady heat exchange, kcal/m²·hr·deg;

l is the distance to the cutting face line, m;

T_r is the rock temperature in the zone of abutment pressure, °C;

$$T_r = 1/l \int_0^l T(l) dl, \text{ } ^\circ\text{C};$$

- α is the heat transfer coefficient, kcal/m².deg.hr;
- λ is the thermal conductivity coefficient of the rock, kcal/m.deg.hr;
- R is the equivalent radius of the workings cross-section, m;
- T_w is the rock temperature on the wall of the workings, °C;
- t_v is the temperature of the ventilating air, °C.

The air temperature at the entry to the longwall t_1 necessary to reach the prescribed temperature at the exit can then be calculated by A.N. Sherban's formula, having regard to our investigations:

$$t_1 = \frac{e^{H_e \Phi} - 1}{H_e} \left(\frac{t_2 H_e}{1 - e^{-H_e \Phi}} - T_e - \frac{\Sigma Q}{G_w c_p} \right), \text{ } ^\circ\text{C},$$

where

$$T_r = \frac{\kappa_r UL + G_c c_c I_c}{G_w c_p} \quad \text{is the longwall heat exchange factor;}$$

$$T_r = \frac{\kappa_r UL + G_c c_c I_c}{G_w c_p} \cdot T_n \quad \text{is the longwall temperature factor;}$$

- Φ is the moisture factor;
- L is the length of the longwall, m;
- U is the perimeter of the workings cross-section, m;
- ΣQ is the total heat liberated by machine operation, kcal/hr;
- G_c is the coal extraction rate, kg/hr;
- c_c is the calorific capacity of the coal, kcal/kg.°C;
- I_c is a coefficient, dependent upon the speed of coal removal from the longwall;
- G_w is the air consumption by weight;
- c_p is the heat capacity of the air.

The calculation showed that it was necessary to heat the ventilating air to $t_1 = +14.6^\circ\text{C}$ in order to reach $t_2 = +4^\circ\text{C}$ at the end of the longwall at an air consumption rate $\theta = 600 \text{ m}^3/\text{min}$, a longwall length $L = 180 \text{ m}$, a natural rock temperature $T_n = -4.7^\circ\text{C}$, and an average rock temperature in the zone of abutment pressure $T_r = -3.8^\circ\text{C}$, whereas heating to

$t_1 = 20^{\circ}\text{C}$ was necessary when no allowance was made for changes in k_r . We suggested using the fluid in the hydraulic systems of the coal cutters as a heat-transfer agent and using the hydraulic system itself as an extended heater for the local booster heating of air, in addition to the well-known methods.

CONCLUSIONS

1. When driving mine workings, the heat field in the frozen country rocks is transformed, first in the course of changes in the state of stress and strain and then in the course of heat and mass exchange with the ventilating air.
2. Changes in the temperature of the rock mass give information on the deformation processes taking place in it.
3. Restoring the temperature of frozen rocks as the stresses in them are redistributed and as the distance from the zone of intensive displacements increases helps to strengthen the ice-cement bonds and so to stabilise the workings.
4. Methods for the local booster heating of air and other methods of protecting the rock mass from the effects of heat should be used to preserve the stability of the country rock surrounding mine workings when above zero temperatures are generated at the cutting faces.

REFERENCES

- KOVALENKO, A.D. Principles of thermoelasticity. Naukova Dumka Press, Kiev, 307 pages, 1968.
- SHERBAN', A.N. and KREMNEV, O.A. Scientific principles of estimating and controlling temperature conditions in deep mines. Vol. 1, Kiev, Academy of Sciences of the Ukrainian SSR Press, 430 pages, 1959.

WATER THAWING OF FROZEN GROUND FOR OPEN PIT AND
UNDERGROUND MINING IN THE NORTHEAST OF THE U.S.S.R.

V.I. Emel'yanov and G.Z. Perl'shtein
All-Union Research Institute of Gold and Rare Metals,
Magadan, U.S.S.R.

Extraction of minerals forms the basis of the economy in the enormous North-Eastern territory of the U.S.S.R.; extraordinary severity of climate and general distribution of permafrost are vital features of this territory. Under these conditions, high outputs from dredges and digging equipment in open-pit workings and greater stability in underground workings are achieved by preparation using heat and water, which means a range of measures to regulate the strength of earth and rock materials by altering the state of aggregation of the interstitial solution and the freezability of individual rock constituents.

A number of new problems in the theory and practice of preparing frozen ground for working using heat and water have been solved during the period which has elapsed since the Second International Conference on Permafrost.

RESULTS OF THEORETICAL RESEARCH ON THAWING OF FROZEN GROUND

Development of numerical methods

The all-Union Research Institute of Gold and Rare Metals and the Special Computer Research Institute, Far Eastern Scientific Centre, Academy of Sciences of the U.S.S.R. have begun joint work on developing mathematical models for the principal methods of artificial thawing and their

implementation by numerical methods using digital computers (Ignatov et al., 1977).

The problem of hydraulic thawing of frozen ground is examined in a generalized orthogonal system of coordinates (x_1, x_2) . The filtration speed field is defined from the solution of the boundary value problem for the equation

$$\nabla \left(\frac{1}{K} \nabla \psi \right) = 0, \quad (1)$$

$$V_{x_1} = -\frac{1}{a} \frac{\partial \psi}{\partial x_2}; \quad V_{x_2} = \frac{1}{a} \frac{\partial \psi}{\partial x_1},$$

where V_{x_1} and V_{x_2} are the filtration speed components in three-dimensional coordinates, m/hr; $K = K(x_1, x_2, T)$ is the filtration coefficient, m/hr; ψ is the current function, m^2/hr , which is linked with the hydraulic head (H, m) by Cauchy-Riemann conditions (Ber et al., 1971):

$$K \frac{\partial H}{\partial x_1} = \frac{1}{a} \frac{\partial \psi}{\partial x_2}, \quad K \frac{\partial H}{\partial x_2} = -\frac{1}{a} \frac{\partial \psi}{\partial x_1},$$

$1/a$ is a coefficient equal to 1 for a "plane" region and to $1/x_2$ for an axisymmetric region.

The temperature field is described by a Fourier-Kirchhoff equation:

$$c_i \frac{\partial T_i}{\partial t} = \nabla (\lambda_i \nabla T_i - C_B V_i T_i) + N(x_1, x_2, t), \quad (2)$$

where T is the temperature, $^{\circ}C$; t is the time, hr; C_i and C_B are the respective heat capacities of a unit of volume of rock and water, $W \cdot hr / (m^3 \cdot ^{\circ}C)$; λ_i is the thermal conductivity coefficient of the rock, $W / (m \cdot ^{\circ}C)$; V_i is the speed of filtration, m/hr, normally $V = 0$ in a frozen zone; N is the power of distributed heat sources, W / m^3 ; the index "i" in unfrozen and frozen zones takes the value "T" and "M" respectively.

Stefan conditions hold good on the boundary of the unfrozen and frozen zones $\tau(x_1, x_2, t) = 0$:

$$T_T = T_M = 0, \quad (3)$$

$$\lambda_M \text{grad } T_M - \lambda_T \text{grad } T_T = Q_\Phi \frac{d\zeta_n}{dt}, \quad (4)$$

where $d\zeta_n/dt$ is the speed of growth of the unfrozen zone on the normal to the interface, m/hr.

The boundary conditions for equations (1) and (2) are prescribed according to the specific versions of the thawing scheme.

An algorithm and program for solving this problem by successive interchange of steady states have now been worked out; here both equations are regarded as a particular case of a general elliptical equation.

The difference equation is obtained by the integro-interpolation method for a system of points in an uneven curved orthogonal network selected so that the limits of integration coincide with the outer lines of the network (Samarskii, 1971). A scheme "oriented against the flow" ensuring stability of solution and a first order of approximation of the differential equation to the finite-difference equations is used for the finite-difference expression of convective terms.

Convergence of the iterative solution is ensured by observing the boundary conditions (for linear systems) and control by the method of successive lower relaxation.

Movement of the phase transition boundary in each time step is monitored by the balance method, by virtue of which the varying geometry of the unfrozen zone does not impair the stability of the solution.

The results of the calculation studies can be used in practice to optimize the hydraulic thawing parameters.

The mathematical model described, reproduces well the thermal and hydraulic processes in water-bearing open taliks. Computer calculations will help to define more precisely the quantitative principles of subterranean water feed and discharge in the permafrost zone.

Convective heat exchange in a water permeable frozen rock mass

Filtration is often observed in frozen water-permeable rock masses both in nature and in the course of the economic development of the North-East U.S.S.R. Open-cut mine terraces consisting of lumps of frozen rock are examples of such masses. When the water moves, phase transitions take place throughout the volume of material; a single unfrozen and frozen zone boundary is not formed. Either the frozen fragments thaw gradually or an ice crust forms on their surfaces first, depending upon the heat content of the filtration flow and the initial temperature of the rock.

The generally accepted methods for quantitative description of convective heat exchange in thawing rocks are not suitable for these cases. A mathematical formulation of the problem of hydraulic thawing of rocks permeable to water in any state of aggregation is given on the basis of the following schematization of the actual process (Perl'shtein et al., 1977):

- a) the temperature field of the filtration flow is one-dimensional;
- b) the change in the water flow rate as a result of freezing (thawing) of the ice crusts is negligible;
- c) the frozen rock fragments are in the form of spheres of equivalent radius R.

When these assumptions are made, heat transfer by the water can be described by the following equation:

$$C_B \frac{\partial T_B}{\partial t} - \lambda_B \frac{\partial^2 T_B}{\partial x^2} - C_B V \frac{\partial T_B}{\partial x} = qS, \quad (5)$$

$(t > 0; \quad X \geq x > 0)$

with boundary conditions

$$T_B(0, t) = T_0, \quad (6)$$

$$\left. \frac{\partial T_B}{\partial x} \right|_{x=X} = 0. \quad (7)$$

Three zones can be distinguished in the solid part of the rock:

- the ice crust, $R \leq r_1 \leq \zeta(x,t)$;
- the unfrozen layer, $\eta(x,t) \leq r_2 \leq R$;
- the frozen core, $0 \leq r_3 \leq \eta(x,t)$.

The thermal conductivity equation in the j -th zone of the solid component (where $j = 1, 2, 3$ in accordance with the above subdivision) takes the following form:

$$C_j \frac{\partial T_j}{\partial t} = \lambda_j \left(\frac{\partial^2 T_j}{\partial r_j^2} + \frac{2}{r_j} \frac{\partial T_j}{\partial r_j} \right) \quad (8)$$

($t > 0$)

The boundary conditions are written separately for each of the zones distinguished.

The ice crust

$$T_1(\zeta, t) = 0, \quad (9)$$

$$\lambda_1 \frac{\partial T_1}{\partial r_1} \Big|_{r=\zeta} - \kappa T_B(x, t) = Q_1 \frac{d\zeta}{dt}, \quad (10)$$

The unfrozen layer

$$T_2(x, R, t) = T_B(x, t), \quad (11)$$

$$T_2(\eta, t) = T_3(\eta, t) = 0 \quad (12)$$

$$\lambda_3 \frac{\partial T_3}{\partial r_3} \Big|_{r=\eta} - \lambda_2 \frac{\partial T_2}{\partial r_2} \Big|_{r=\eta} = Q_{2-3} \frac{d\eta}{dt} \quad (13)$$

Conditions (12) and (13) hold true on the external boundary of the frozen core, and the following at the centre:

$$\frac{\partial T_3}{\partial r_3} \Big|_{r=0} = 0. \quad (14)$$

At the initial point in time the mass temperature is a function of one three-dimensional coordinate

$$T(x, r, 0) = T(x). \quad (15)$$

Term q in equation (5) is the density of the heat flux from the water to the solid components of the rock. The magnitude of q is determined by the following expression, depending upon whether an ice crust is present ($\zeta > R$) or absent ($\zeta = R$):

$$q = \begin{cases} \kappa T_B(x, t), & \zeta(x, t) > R \\ \lambda_2 \frac{\partial T_2}{\partial r_2} \Big|_{r=R}, & \zeta = R \end{cases} \quad (16)$$

The specific surface $S(\text{m}^{-1})$ remains constant or decreases continuously in proportion to the thawing and breakup of the frozen spheres, depending upon the properties of the rocks.

The following symbols were adopted in expressions (5) - (16) in addition to those given previously: x is a coordinate which coincides with the direction of the filtration speed vector, m ; r is the distance from the centre of the spherical rock fragments, m ; ζ and η are the respective distances from the centre of the spheres to the surface of the ice crust and the outer boundary of the frozen core, m ; Q is the heat expended on phase transitions in a unit of volume, $\text{W}\cdot\text{hr}/\text{m}^3$; k is the coefficient of heat exchange between the water and the disintegrating fragments of rock, $\text{W}/(\text{m}^2\cdot^\circ\text{C})$; X are the dimensions of the investigation region, m .

It is doubtful whether the problem can be solved analytically in this formulation. In future, numerical solutions using digital computers are proposed.

Power of heat sources in thawing frozen ground by electric current

Tubular needle electrodes are normally used for thawing large masses of frozen ground with currents of industrial frequency, inserting them in a staggered pattern on a network of equilateral triangles. Each electrode interacts with the six neighbouring electrodes, which are at the same distance $2R_0$ from it.

An approximate method of assessing the intensity of Joule heat sources has been developed to control the process (Perl'shtein, Savenko,

1977). The zone of influence of one needle can be likened to a cylinder of radius R_3 , with a level of error permissible in practical calculations. The effective potential difference (U_0, V) will be equal to half the supply voltage. Assuming that the electrical resistance of the frozen ground with slight interstitial solution mineralization does not depend upon the temperature (Yakupov, 1973) it is easy to obtain analytical expressions for the electric field characteristics, in particular the total power of the Joule heat sources in the unfrozen (P_{unfrozen}) and frozen (P_{frozen}) zones:

$$P_T = \frac{2\pi U_0^2 \ln \frac{r_T}{r_0}}{\rho_T \left(\ln \frac{r_T}{r_0} + \frac{\rho_M}{\rho_T} \ln \frac{R_3}{r_T} \right)^2}, \text{ B}\tau/\text{M}, \quad (17)$$

$$P_M = \frac{2\pi U_0^2 \frac{\rho_M}{\rho_T} \ln \frac{R_3}{r_T}}{\rho_T \left(\ln \frac{r_T}{r_0} + \frac{\rho_M}{\rho_T} \ln \frac{R_3}{r_T} \right)^2}, \text{ B}\tau/\text{M} \quad (18)$$

where ρ_{unfrozen} and ρ_{frozen} are the respective specific electrical resistances of the unfrozen and frozen ground, $\Omega \cdot \text{m}$; r_0 is the electrode radius, m; r_{unfrozen} is the radius of the unfrozen zone, m.

Figure 1

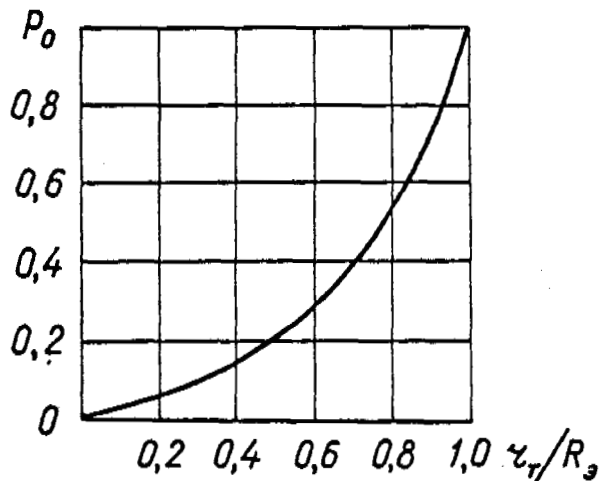

Relationship of relative heat release in unfrozen zone P_0 to dimensionless radius of talik r_T/R_3

The graph shown in Figure 1 was plotted from formulas (17) and (18) for $\rho_{\text{frozen}}/\rho_{\text{unfrozen}} = 20$ and $R_3/r_0 = 100$;
 $P_0 = P_{\text{unfrozen}}/P_{\text{unfrozen}} + P_{\text{frozen}}$

The graph clearly shows that expansion of the unfrozen zone is accompanied by an increase in unproductive heating of the thawed ground. In the interests of economy it is therefore recommended that the electric power supply routine should be intermittent or that the voltage in the circuit should be gradually reduced.

DEVELOPMENT AND ADOPTION OF NEW PRACTICAL RECOMMENDATIONS

Working of thawing ground layer by layer

Most of the frozen ground in mining and construction areas in the North-East of the U.S.S.R. is worked by periodic removal of layers as they thaw. The optimum routine for overburden removal which simultaneously ensures a satisfactory rate of thawing and sufficient output from the equipment can be selected on the basis of forecasting ground thawing depths, taking into account the thermal interaction of the ground with the atmosphere. This problem has been considered in work by V.T. Balobaev, V.A. Kudryavtsev, V.S. Luk'yanov, A.V. Pavlo, G.V. Porkhaev and other workers. Modern methods of allowing for factors of "external" heat exchange (Kurtner, Chudnovskii, 1969; Perl'shtein, Stafeev, 1971; Pavlov, Olovin, 1974) make it possible to forecast the speed of ground thawing from weather station data. In these circumstances the average surface temperature is closely dependent both upon the climatic characteristics and upon the properties of the ground and the duration of thawing (Figure 2a).

The All-Union Research Institute of Gold and Rare Metals has made a number of thermophysical calculations applicable to climatic conditions in the extreme North-East of the U.S.S.R. Curves showing the relationship of average surface temperature and depth of layer thawing to time (Figure 2) have been obtained for four typical varieties of earth material.

These graphs are of great assistance to production staff in planning the preparation of frozen ground for bulldozer and scraper working.

Figure 2

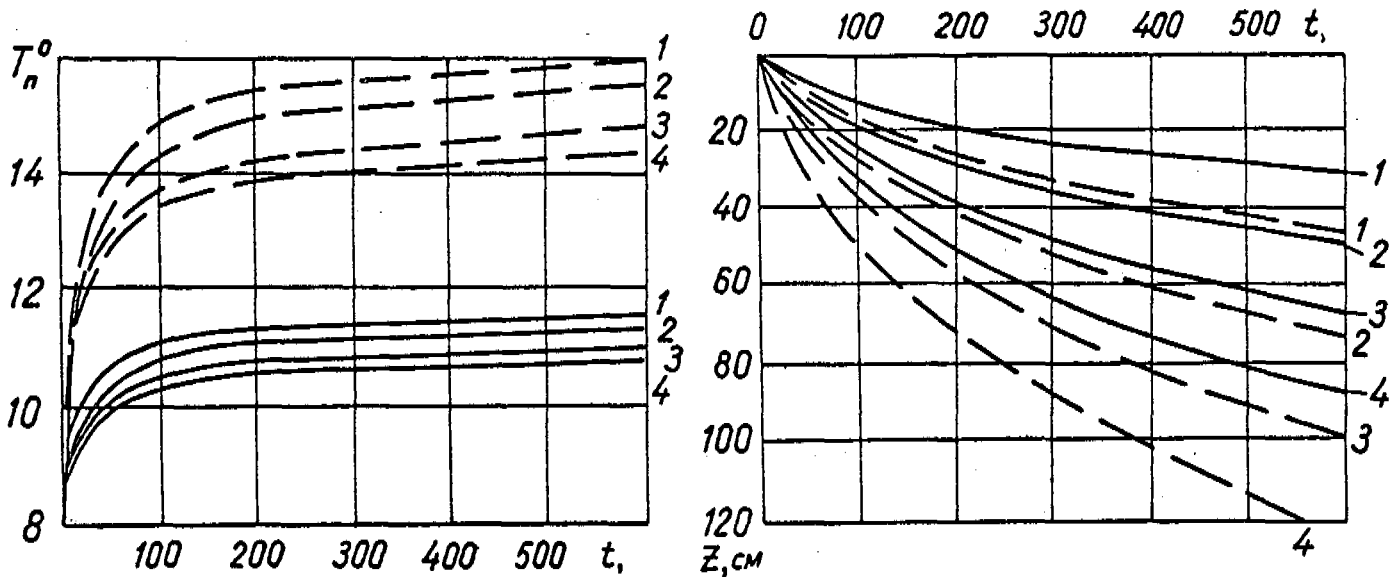

Changes in average ground surface temperature (a) and unfrozen layer thickness (b) in July according to time
 1 - gravel (ice content 125 kg/m^3); 2 - gravel (ice content 250 kg/m^3); 3 - detrital supes (ice content 400 kg/m^3);
 4 - peat-covered suglinok (ice content 600 kg/m^3). The broken line relates to the upper reaches of the Kolyma, the solid line to the extreme North-East of the U.S.S.R.

Intensification of filtration-drainage thawing

In the North-East of the U.S.S.R., the widespread distribution of coarsely fragmented deposits highly permeable to water favours the use of filtration-drainage thawing.

According to the simplest method of calculation for filtration-drainage thawing (Gol'dtman et al., 1970), the filtration flow relative heat transfer is

$$B_T = 1 - \sum_{n=1}^{\infty} B_n \exp(-\mu_n^2 F_0),$$

where

$$\mu_n = \frac{\pi}{2}(2n-1); B_n = \frac{2}{\mu_n^2}; F_0 = \frac{\lambda l}{C_B V_{\phi} h^2}; \quad (19)$$

l is the distance between the irrigation and drainage channels, m; h is the average thickness of the aquifer, m.

As a rule, $F_0 < 0.5$ in practice. In these circumstances expression (19) can be replaced by the following relationship with an error of not more than 5%:

$$B_T = 2\sqrt{\frac{F_0}{\pi}} \quad (20)$$

This gives an opportunity to represent the depth of thawing Z by the following formula, which is convenient for analysis and planning:

$$Z = Z_0 + 2 \frac{T_B t}{Q_0 l} \sqrt{\frac{\lambda_T C_B K \cdot y}{\pi}}, \text{ m.} \quad (21)$$

where y is the depth of drainage, m.

Analysis of formula (21) made it possible to recommend a reduction in the depth of the drainage channels, with a simultaneous proportional increase in their frequency. In these circumstances the speed of thawing increases, the amount of earthmoving is reduced somewhat, and conditions for the gravity-flow discharge of water are greatly facilitated. Observance of the relationships $y/z > 0.3$ and $l/z > 2.5$ gives sufficiently uniform thawing between the drainage and irrigation channels.

Adoption of these recommendations makes it possible to increase the extent of filtration-drainage thawing and yields substantial savings.

Industrial thawing of frozen ground with preheated water

The perfection and introduction of a technology for thawing frozen ground using preheated water is of great importance in the light of the prospects of using atomic water heaters, geothermal heat extraction systems, and other cheap energy sources in the immediate future. The first examples of contact-type low-temperature heaters for preheating contaminated water (with a power of about 3 megawatts) were manufactured in the Magadan Oblast in 1974.

Research was carried out at the same time at the All-Union Research Institute of Gold and Rare Metals on the features of heat exchange when a high-potential heat-transfer agent was used (Kapranov, 1977). The maximum possible heat losses to the atmosphere from the polygon surface were calculated for various technological schemes in the upper reaches of the Kolyma and the extreme North-East of the U.S.S.R. Methods of calculating thawing speed with a recirculating water supply have been validated.

Methods of starting a system where there is no initial unfrozen layer, organising a recirculating water supply, and other aspects of the technology have been tested and perfected under production conditions.

This method is already making it possible to smooth out seasonal fluctuations and increase the volumes of overburden removal in taliks, with the result that increased annual outputs from earthmoving equipment and substantial savings are being achieved.

PREPARATION OF ARTIFICIAL SUSHENTSY*

There are now two well-developed trends in combating the seasonal freezing of unfrozen ground: thermal protection, and reducing the interstitial solution crystallization temperature by the injection of salts. In the case of coarsely fragmented deposits there is a promising and essentially new way: weakening the ground by reducing its moisture content before freezing begins.

Sushentsy, loose deposits which remain easy to separate after freezing, are encountered in many river valleys in the North-East of the U.S.S.R. They are usually composed of well-washed shingle-gravel material. The mapping of natural sushentsy zones and correct planning of the overburden removal sequence at enterprises is an important source of spare capacity for increasing the output of earthmoving equipment during the autumn-winter period (Emel'yanov, 1973).

* Sushentsy - dry, well drained coarse gravel low moisture content.

A range of investigations was completed at the All-Union Research Institute of Gold and Rare Metals in 1974-1976 to determine whether artificial sushentsy could be created, using technology available in large-scale mining production.

A full-scale experiment in artificial sushentsy preparation was carried out in the valley of the River Berelekh, using hydraulic-needle thawing and drainage of coarsely fragmented ground. Deposits prepared in this way remained easy to separate after they had frozen completely. They were worked to their full depth (over 4 m) by a 100-horsepower bulldozer in February 1975, at an air temperature of about -50°C . At 15-centimetre layer which did not differ lithologically from the rest of the bed but which had retained its solidity was encountered at a depth of 1.5 m. The ice content relative to a dry batch in two specimens from this layer was 3.19 and 3.46%. The total moisture content of specimens of easily separable earth material varied from 1.11 to 3.39%.

The resistance of the frozen ground to rapid shear and fracture (at a specimen loading speed of up to $20 \text{ kgf}/(\text{cm}^2 \cdot \text{min})$) and to instantaneous shear was studied under laboratory conditions (Kuril'chik, Perl'shtein, 1976). A mixture of 90% sand-shingle material (0.4 - 2.5 mm) with 10% dust-clay particles ($< 0.05 \text{ mm}$) in the 2 - 10% total moisture content by weight range was studied. A considerable increase in the strength of specimens when their moisture content increased was observed in all types of test. The change in strength characteristics was particularly abrupt in the 3 - 5% moisture range (Figure 3).

Figure 3

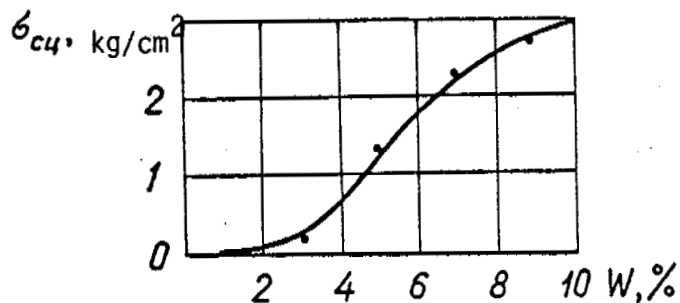

Relationship of instantaneous cohesion σ of a sand-shingle mixture to total moisture content W at a temperature of about -1°C .

Thus laboratory tests and a full-scale experiment showed that frozen ground with a total moisture content of up to 3 - 3.5% (the critical moisture content) remains easy to separate even during severe frosts.

Experiments in knockdown columns revealed the decisive role of the dust-clay particle content in ground residual moisture content and established the high speed of drainage in coarsely fragmented alluvial deposits in the valley of the River Berelekh.

As a result of the first stage in the investigations, river valley sectors with alluvium of the following composition are recommended for the preparation of artificial sushentsy: pebbles and shingles 60 - 80, sand 15 - 30, dust and clay not exceeding 5 - 10%.

The course of drainage is calculated by a programme developed by the numerical methods group at the Leningrad Northern Hydraulic Engineering and Land Reclamation Research Institute for Minsk-22 and Minsk-32 computers. The first computer studies give reliable indications of the possibility of preparing sushentsy in ground with a fine-grained filler; this will extend the scales and range of application of the new technology considerably.

STUDIES OF ICE LAYER BUILDUP IN UNDERGROUND WORKINGS

In 1975-1976 the All-Union Research Institute of Gold and Rare Metals conducted research on heat exchange in ice layer buildup by A.I. Blinskii's method (1946) in three operational mines. During the experiments the external air temperature varied from -12 to -50°C and the speed of the air flow in the mines from 0.5 to 2.4 m/sec. The thickness of the lining was varied in the 0.5 - 6 cm range.

The observations revealed that 75 - 80% of the total amount of heat of crystallization was carried away by convective heat exchange with the air, more than 15% was removed by radiant heat exchange between the water-ice surface and the roof and wall rocks, and 7% was lost in evaporation.

It was established that the effect of the water layer thickness upon the speed of ice buildup was more apparent at high air flow speeds.

Recommendations for a water feed routine according to the air flow rate and the cross-sectional area were made.

It was made clear that the average rate of freezing achieved (12 cm/day at an air temperature of about -40°) can be increased by 1.5 - 2 times by increasing the speed of the air flow.

Pilot-scheme tests showed that it was technically possible and economically expedient to use the flushing of placer mines with ice under particular conditions.

CONCLUSION

The above results of experimental, theoretical and practical development work by specialists from the All-Union Research Institute of Gold and Rare Metals certainly do not exhaust the whole range of problems in the preparation of frozen ground using heat and water.

The Irkutsk State Rare Metal Industry Research and Design Institute is doing much to improve the thawing of frozen ground by surface thermal reclamation, having developed a technology for protecting unfrozen ground from freezing with solidifying water-air froths. The mining thermophysics laboratory of the Leningrad Mining Institute is working on the problem of extracting geothermal heat and using it to thaw frozen placers. Members of the laboratory staff have developed and tested a new explosive-hydraulic method of thawing. The results of research by the Permafrost Institute, Siberian Section, Academy of Sciences of the U.S.S.R. on problems of thawing frozen ground by heat from solar radiation are being utilized at mining enterprises in the North-East of the U.S.S.R. More and more use is being made of progressive methods of permafrost prospecting now being developed at the Permafrost Institute, PNIIS", Moscow State University, and other organizations in the country.

It should be noted that until recently the methods of frozen ground preparation using heat and water have been used mainly in dredging areas when working placer deposits (with the exception of natural thawing).

Their large-scale adoption into practice in working placers by sorting is only just beginning, but has already yielded appreciable savings. Further researches to extend the theory, to develop new technologies, and to improve existing schemes for the preparation of permafrost placers using heat and water are among the main trends in scientific and technical progress in the mining industry in the North-East of the U.S.S.R.

REFERENCES

- BAKAKIN, V.P. and PORKHAEV, G.V. The principal methods of ground reclamation using water and heat over large areas, in: Principles of Geocryology (Permafrost), Part 2, Moscow, Academy of Sciences of the U.S.S.R. Press, pp. 118-140, 1959.
- BLINSKII, A.I. Underground working of coal and ore deposits in the permafrost region by ice flushing of worked-out spaces, in: Permafrost, Vol. 1, No. 2, Moscow, Academy of Sciences of the U.S.S.R. Press, pp. 131-135, 1946.
- BER, Ya., ZASLAVSKI, D. and IRMEI, S. The physico-mathematical principles of water filtration, Moscow, Mir Press, pp. 59-62, 1971.
- GOL'MAN, V.G., ZNAMENSKII, V.V. and CHISTOPOL'SKII, S.D. Hydraulic thawing of frozen ground, Proceedings of the All-Union Research Institute of Gold and Rare Metals, Vol. 30, Magadan, pp. 335-342, 1970.
- EMEL'YANOV, V.I. Measures to prolong overburden removal in permafrost placers, Kolyma, No. 1, pp. 6-7, 1973.
- IGNATOV, A.A., PERL'SHTEIN, G.Z. and CHERNYKH, E.Ya. Numerical solution of a frozen ground hydraulic thawing problem. Proceedings of the All-Union Research Institute of Gold and Rare Metals, Vol. 37, Magdan, pp. 11-19, 1977.
- KAPRANOV, V.E. Study of the process of preparing frozen ground for excavation by thawing with preheated water, Authr's abstract of candidate dissertation, Leningrad Mining Institute, p. 24, 1977.
- KURIL'CHIK, A.F. and PERL'SHTEIN, G.Z. Study of strength of frozen ground in rapid shear, Kolyman, No. 9, pp. 8-9, 1976.
- KURTENER, D.A. and CHUDNOVSKII, A.F. Calculation and regulation of temperature conditions in exposed and protected soil, Leningrad, Gidrometeoizdat, pp. 52-79, 1969.
- PAVLOV, A.V. and OLOVIN, B.A. Artificial thawing of frozen ground by heat from solar radiation in placer working, Novosibirsk, Nauka Press, pp. 141-153, 1974.

PERL'SHTEIN, G.Z., ZINCHENKO, A.I. and KORSHUNOV, G.I. Hydraulic thawing calculations for frozen water-permeable rock masses. Proceedings of the All-Union Research Institute of Gold and Rare Metals, Vol. 37, Magadan, pp. 3-6, 1977.

PERL'SHTEIN, G.Z. and SAVENKO, L.P. Approximate calculation of distribution of heat source intensity in electric thawing of frozen ground, Ibid., pp. 156-160, 1977.

PERL'SHTEIN, G.Z. and STAFEEV, P.F. Determining rock surface temperature by calculation, Kolyma, No. 6, pp. 15-18, 1971.

SAMARSKII, A.A. Introduction to the theory of difference systems, Moscow, Nauka Press, pp. 232-237, 1971.

YAKUPOV, V.S. The electrical conductivity of frozen ground. Second International Conference on Permafrost, Papers and Communications, No. 4, pp. 157-160, 1973.

PERMAFROST - HYDROGEOLOGICAL ZONING OF EASTERN SIBERIA

P.I. Mel'nikov, Institute of Permafrost, Siberian Branch, USSR Academy of Sciences and O.N. Tolstikhin, All-Union Research Institute of Hydrogeology and Engineering Geology

Introduction

The publication of the multivolume monograph "The Hydrogeology of the USSR", a series of monographs on the morphology of permafrost that summarize papers describing the distribution of icing phenomena, together with theoretical treatises on questions relating to the changes that occur in the hydrogeological parameters of structures when subjected to freezing to great depths, which were reported in papers presented at the Second International Conference on Permafrost (1,2), make it possible to enter into a discussion concerning regional aspects of permafrost hydrogeology, with specific reference to Eastern Siberia. Before proceeding to the essence of the discussion, however, it seems desirable to consider the terminology that has been adopted. We shall consider only those terms which have not yet been extensively used in the literature, are capable of being variously interpreted, or are necessary to obtain an understanding of the fundamental positions taken by the authors.

Two categories of structures are analysed: hydrogeological masses (HM), which are often synonymous in the literature with the term 'basins of fissure waters', and artesian basins (AB), with their typical two-stage arrangement involving the presence of stratal waters in the surface deposits and fissure waters in the basement (3). The intermediate categories of structures are defined as adartesian basins (AdB) and hydrogeological admasses (AdM). Although these structures contain fissure waters and stratal waters in approximately equal proportions, in terms of their morphological features they tend to be artesian basins or hydrogeological masses respectively.

Among the artesian basins it is necessary to distinguish platform and intermontane ABs. Not only do they always differ in their dimensions. They also differ in the composition of the surface cover, the hydrochemical section, and the conditions of recharge, that is, in a whole series of additional characteristics which in many ways determine the hydrogeological parameters of these structures.

Also placed in a special category are hydrogeological structures of volcanic origin. Being superimposed on various geological formations, these structures have been named volcanogenic superbases (VsB).

The analysis of the permafrost characteristics is based primarily on the state of discontinuity of the permafrost. Thus, we distinguish a continuous permafrost zone, where permafrost occurs in at least 80 per cent of the total area, a discontinuous permafrost zone, where its areal range is between 40 and 80 per cent, and a sporadic permafrost zone, where islands occupied by frozen earth materials amount to less than 40 per cent. Here, permafrost means earth materials of which the frozen state (a negative temperature on the Celsius scale and the presence of ice cement) is typical, sustained and persistent.

It is apparent from an analysis of a large body of hydrogeological data that within areas of sporadic and discontinuous permafrost the latter do not exert a decisive influence on the character of the hydrogeological structures or on their hydrodynamic parameters. Therefore, no further analysis is made with respect to such areas. In areas of continuous permafrost the question of the permafrost thickness and the depth of freezing of the interior is of decisive importance under the conditions obtaining in diverse hydrogeological structures. The following are distinguished as specific structures on the basis of the conditions of freezing (4):

- cryogeological masses, in which the permafrost thickness is much greater than the thickness of the possible regional distribution of the subsurface waters and the latter, accordingly, may be confined to zones of very deep faults or to areas which are subject to karsting of marbled rocks;

- cryogeological basins, being artesian structures in which the sedimentary surface is completely frozen and the subsurface waters can concentrate only in the foundation;

- cryoartesian basins, in which the belt of fresh water is frozen and immediately below the permafrost there are saline waters and brines;

- artesian basins of continuous deep freezing, characterized by the regional development of a continuous permafrost zone and of fresh and weakly brackish subsurface waters at its base.

In addition, the following terms are used:

- cryopegs: saline waters and brines with a temperature constantly below 0°C;

- active layer: a seasonally thawing or seasonally freezing layer;

- permafrost; earth materials, the frozen state of which persists for many years.

The zoning of Eastern Siberia is accomplished on structural-hydrogeological principles, as represented in composite generalizing papers (1,5) and on the map pertaining to them.

Distinguished as first-order structures in the area constituting Eastern Siberia are the East Siberian artesian region and the East Siberian, the Verkhoyansk-Chukotsk and the Kamchatka-Koryakh hydrogeological folded regions. In the remainder of this report we shall consider them successively at the boundaries where cryogenetic processes are determining the conditions under which hydrogeological structures and the subsurface waters within them are forming.

1. The East Siberian artesian region. In its geological conditions the region is a fairly complex structure, characterized by the development of several basins filled with sedimentary deposits of differing age, origin and composition, and separated from one another by structural uplifts of the basement. The structural basins form large ABs of the platform type: the Angara-Lena, the Tungusska, the Kotui, the Yakut, the Olenek and the Khatanga. The largest of the structural uplifts: the Anabar massif, is a surface outcrop of the crystalline and metamorphic rocks of the basement and extends over a vast area. In the south the ABs of the East Siberian region are linked with the Sayan- and the Baikal-Aldan hydrogeological folded regions.

The surface of the ABs of Eastern Siberia is composed of variously aged formations, differing moreover, in the lithological composition of the rocks and in their geochemical properties. Widely distributed over the vast area of the Angara-Lena AB, in the western and southwestern parts of the Yakut AB and in the eastern and southeastern parts of the Tungusska AB are Upper Proterozoic and Paleozoic (Cambrian - Devonian) terrestrial-carbonaceous and carbonaceous formations, frequently halogenic or containing essentially sulphatic mineralization. The central part of the Yakut AB - the Lena-Vilyui second-order AB - is composed of thick series of terrestrial Mesozoic formations, essentially of continental origin. In contrast to the Lena-Vilyui, the Tungusska AB consists of terrestrial-volcanogenic deposits of considerable thickness. In the section of the Khatanga AB, sandy-clayey deposits of Mesozoic and Upper Paleozoic age are underlain by Middle Paleozoic halogenic formations.

The marked diversity in the composition and structure of the earth materials constituting the East Siberian artesian region is further emphasized by morphostructural variations. Over much of the area its surface is dissected to differing degrees by plateaus, the elevation of which decreases overall in the basin of the Vilyui and the Lena, where it passes initially into a high and then into a low plain of erosion and erosion-aggradation.

The most elevated part of the surface, the Putorana Plateau, is a laval tectonic-denudational formation which, in the thickness of its basalt sheets, amounting to as much as 2 to 2.5 km, can be regarded as a volcanogenic superbasin.

Within the areas consisting of terrestrial-carbonaceous, essentially helogenic surface formations, their relatively deep drainage has given rise to conditions that are unfavourable for the formation of a thick belt of fresh water, with the result

that relatively close to the surface, less than 200 m below it, there are saline waters or brines. An opposite picture was observed within the areas consisting of preeminently continental formations, for example, in the Vilyui syncline, where a thick belt of fresh subsurface water extending for many hundreds of metres was able to form in the Cretaceous and Upper Jurassic deposits. It is probable that closely similar hydrochemical conditions obtained within the Putorana Plateau, the hydrogeological structure of which was complicated by tectonic valleys filled with thick, unconsolidated, molasses-like deposits. Occupying an intermediate position were areas devoid of halogenic or gypsiferous facies within the carbonaceous-terrestrial complex, for example, on the northern limb of the Aldan anticline, where at relatively small depths, weakly brackish sulphatic or chloride waters might have been expected to be present. Parallel with the variations in the hydrochemical parameters, considering the deeply dissected nature of the surface terrain of the platform, the non-uniformity in the composition of the surface material, and its tectonic dislocation by regional and feathering faults, a substantial variation in the hydrodynamic conditions might also be expected.

All that has been said makes it possible to conclude that a fairly non-uniform hydrogeological and hydrochemical situation existed within the East Siberian artesian region by the time that the permafrost zone began to form and the surface of the artesian structures became deeply frozen (6). In general outline, the process would appear to have been as follows.

Obviously, the freezing of the interior, due to the general cooling of the climate and the increase in its continentality during the Pleistocene, must have taken place in different ways, depending on the locally prevailing geomorphological, hydrogeological and geochemical situation.

Given the existence of the thick zone of fresh subsurface waters and the low-lying components of the relief, particularly in the central part of the Lena-Vilyui AB, in the course of the cooling of the interior, freezing of the water-bearing horizons occurred. This was accompanied by precipitation from the freezing subsurface waters of the most difficultly soluble salts of calcium and magnesium, some carbonization of the section, distillation of the ground ice and concentration of the dissolved salts in front of the freezing plane. Under these conditions its thickness attained maximum values: up to 650 metres, and all of the upper water-bearing horizons remained completely frozen.

An opposite picture was observed in the areas containing the carbonaceous and carbonaceous-terrestrial halogenic deposits, which are relatively poorly drained and contain saline waters and brines at small depths. Under such conditions the cooling of the interior led to comparatively rapid freezing of the upper part of the section, normally extending to 200-300 m, following which, slow and protracted cooling of the saline waters and brines began. Their temperature dropped to below 0°C and the

cooling gradually encompassed the upper part of the hydrogeological section to a depth of 1450 m.

The cooling of the basins composed of terrestrial and carbonaceous deposits that were devoid of brines and highly concentrated saline waters in their upper horizons led to gradual freezing of the upper part of the section, analogous to the freezing of the fresh water deposits. The thickness of the permafrost, however, proved to be somewhat less and at its base, a belt of waters with temperatures below 0°C, i.e. cryopegs, also originated. It was not such great thickness, however, as this occurred in the halogen sections.

Simultaneously with the increase in depth the freezing encompassed all of the major areas, gradually advancing from the highest to the lowest tracts and from north to south, shrinking the areas of the taliks, radically altering the conditions providing for an interconnection between the subsurface and surface waters, and also the hydrodynamic structure of the zone of impeded and unimpeded water exchange between the artesian structures of the Siberian Platform. In the northern part of the East Siberian artesian region these processes embraced all of the artesian structures, independently of their constituent materials, while in the south, within the areas containing the carbonaceous karst deposits the permafrost retained its discontinuous character and the subsurface waters - their fairly rapid recharge.

In conformity with the character of the hydrochemical section, in a vast portion of the area containing the Tunguska AB, in the western part of the Yakut AB, and in the Kotui, the Olenek, and in part, the Khatanga ABs, the zone containing the fresh waters was completely frozen, a thick series of cryopegs formed and the artesian basins passed into the cryoartesian phase of development.

In discussing the phenomenon of the deep freezing of artesian structures and their transition to the cryoartesian phase of development, one cannot avoid emphasizing the fact that the latter is a qualitatively new hydrostructural formation, the properties of which are determined by:

- the presence of a regional water-resisting permafrost stratum, the thickness of which varies with time;

- the absence of a regional and persistent zone of unimpeded water exchange and of the fresh subsurface waters that typify it;

- the presence of a belt of cryopegs : waters and brines below 0°C at the base of the permafrost, and of a lens of cryopegs at its distal limits;

- the hydrochemical and hydrodynamic processes caused by fluctuations of the permafrost base, and by its thawing and freezing following periods of warming or cooling;

- the low piezometric levels of the subsurface waters, often featuring, besides a low temperature and high mineralization, a high gaseous factor as well;
- the combining of the subsurface waters in the cryohydrate form.

Information about all of these characteristics, properties or processes occurring in cryoartesian structures was published in the Proceedings of the Second International Conference (7) and in a number of other papers by Soviet hydrogeologists (8,9), which makes it possible to dwell on certain aspects only of the formation of the subsurface waters of these structures.

One of the most complex and least studied questions is the hydrodynamic conditions under which the subsurface waters form. It is not our intention to propose a new theory of the mode of development of the low piezometric levels of the subsurface waters. Such low levels are typical of these structures and have been variously interpreted by the investigators concerned with this problem. We merely wish to emphasize that the recharging of subpermafrost water from the surface is ruled out under the conditions obtaining in cryoartesian structures.

Actually, even in the most deeply frozen artesian basins, most of which are similarly characterized by low piezometric levels, the presence of an open permeable talik suffices to permit an interconnection between the surface and subsurface waters. In cryoartesian structures the highly concentrated saline waters and brines have fairly low below-freezing temperatures, in some cases reaching -14°C (Nordvik), and the fresh waters percolating from the surface must inevitably freeze under such conditions. This has been confirmed by experiments conducted by the Institute of Permafrost, Siberian Branch of the USSR Academy of Sciences, at one of the deposits in the southern part of the Siberian Platform. It would seem that in the absence of surface recharge, in the ABs being described a stabilization of the hydrodynamic situation should ensue. In actual fact, the absence of opportunities for surface recharge does not attest to hydrodynamic stability in the structures being discussed. Rather, the presence of saline springs in the basin of the Vilyui and the Greater and Lesser Tunguska rivers affords evidence of the enormous power of the relatively active hydrodynamic regime.

One of the causes of this could be thawing of the permafrost from below and the resulting origination of the so called pressure head deficits. As indicated by field data derived in recent years, this thawing of the permafrost from the base does not take place uniformly. In any case, the thickness of the permafrost above the regional fault zones is proving to be from 60 to 80 m less than it is away from the influence of these zones. If, however, the thawing of the permafrost does not occur uniformly, the pressure head deficits must also be non-uniformly distributed. They should be maximal where this thawing has attained maximal values. Consequently, in these zones of maximal thawing and maximal pressure head deficit,

there should also exist zones of potential absorption. Field data derived in the course of exploring subsurface waters at a number of sites in the western part of the Yakut artesian basin lend support to these ideas. Hence it is possible to draw a somewhat unexpected general conclusion: the permafrost, being a regional water-resisting stratum that had originated at the site of a zone of unimpeded water exchange, stimulates by virtue of the dynamic nature of its development the activation of the hydrodynamic processes in the upper subpermafrost levels. In eliminating unimpeded water exchange with the surface, it contributes to the activation of an internal water exchange.

What ought to be the orientation of this internal water exchange? In order to answer this question it is necessary to consider two facts.

The first is that the deficit of pressure waters always originates in the upper subpermafrost water-bearing horizons. This was clearly indicated in Volume 20 of "The Hydrogeology of the USSR" (10). As a result, the pressure heads of the subsurface waters of the aquiferous horizons occurring lower down the section are, as a rule, larger than those higher up. Consequently, the origin and development of a pressure head deficit tends to give rise to vertical migration of the fluids of the hydrogeological section from below upwards.

The second fact is that maximal thawing of the permafrost is traced along linearly elongated zones corresponding to the fault zones. It should be noted that in these zones the water conductivity of the ground undergoes a twofold or threefold increase. Consequently, the origin and development of a pressure head deficit leads to a second general tendency, which is for the subsurface waters to overflow along the stratum from the zones of minimal thawing into the zones of maximal thawing.

All this makes it possible to draw yet another general conclusion: the dynamics of development of permafrost superimposed on a complex geostructural background are conducive to further complication of the regional hydrodynamic structure of the cryoartesian basins and to unevenness in the water supply to the upper part of the section containing the subpermafrost waters, thus greatly complicating the possibilities of installing mains services in the available underground space.

What has been said, however, does not only apply to the subpermafrost part of the hydrogeological section. Hydrogeological surveys and special exploratory studies have shown that in the upper part of the section as well, within the confines of the regional distribution of the permafrost, there have remained unfrozen zones with a particularly high water conductivity. The nature of these zones is associated either with U-shaped valleys that are primarily tectonic in nature and are filled with molasses-like sandy-pebbly deposits, or with faults, cutting across the carbonaceous rock mass and river valleys of varying depths (the basin of the Vilyui River). In the latter case the high potential water conductivity is

combined with especially favourable conditions of year-round recharge, which interferes with the freezing of these zones and is conducive to their remaining in the unfrozen state. There is reason to believe that highly water-abundant zones such as these may also be associated with certain distinctively fissured trappe bodies and possibly with dikes. Indirectly indicative of this are the thick icings manifested in the upper reaches of some of the river valleys that have their sources in trappe uplands.

Artesian basins of continuous deep freezing, such as the Lena-Vilyui, over a larger area - the Khatanga, and in part, in the western portion - the Tunguska, resemble cryoartesian basins in a number of their features and in the processes occurring within them. They differ mainly in the absence of a belt of cryopegs and all of the distinctive features associated with the development of such a belt, which have already been discussed. Furthermore, the preeminently terrestrial composition of the materials forming the surface of these artesian basins results in a more uniform thawing of the permafrost and accordingly, in a more uniform water conductivity of the earth materials along the stratum.

Analysis of the static levels of the first subpermafrost water-bearing horizon indicates that the numerous talik windows that formed as a result of the thermal interaction of the permafrost with the rivers or lakes at the surface are not centres of recharge of subpermafrost water-bearing horizons, although the freezing conditions may not impede this. The lack of an interconnection is due to the lithological water-resisting strata, which have a highly effective segregating role in the limited areas where open taliks are present. In addition, the results of flow rate observations and radioisotope studies indicate that an intensification of the water exchange is presently occurring and that this is associated with the shaping and expansion of the region of the pressure head deficit and with the lack of hydrodynamic equilibrium between the individual elements of the complex pressure head system of these artesian basins (9, pp. 9-14). Consequently, as in the cryoartesian basins, the shaping and character of the hydrodynamic structure of ABs of continuous deep freezing are in many ways determined by the dynamics of development of the permafrost. These also determine the character of the upper part of the hydrogeological section: above the permafrost and within it. It is more complex in these structures because of the presence of numerous lake basins and lakes, which may be relict or newly formed and thermokarst, but which in all cases had led to the formation of water-bearing taliks below the lakes. Under favourable lithological conditions: the presence of earth materials with a high water conductivity, usually within a Quaternary complex of deposits, the taliks under the lakes are united with the valley taliks. Furthermore, complex supra- and intrapermafrost basins of subsurface waters and subartesian intrapermafrost waters, preeminently of lacustrine or condensation recharge, also originate within the permafrost. The discharge of these waters is manifested in the emergence of springs with a high rate of discharge, usually forming large icings (9, pp. 35-45).

In the north-south direction, the cryoartesian basins and the artesian basins of continuous deep freezing give way to the following basins containing discontinuous permafrost: the Aldan limb of the Yakut AB, the Upper Lena AB, the southern and southwestern margins of the Tunguska AB. Their hydrodynamic conditions are closely similar to ABs untouched by deep freezing and it is only the hydrochemical conditions that attest to the different, more severe permafrost situation that formerly existed here, a situation which corresponded to the above described hydrogeological structures.

Of considerable interest in terms of its permafrost hydrogeology is the Anabar Shield. Thermophysical calculations made by Yu. G. Shastkevich have shown that the permafrost thickness exceeds 1000 m there. Given the conditions under which the crystalline and metamorphic rocks developed, the probability of appreciable resources of subsurface waters being present at these depths appeared to be very low. Because of this the Anabar Shield was numbered among the cryogeological masses. However, geophysical data derived in recent years at the Institute of Permafrost, Siberian Branch of the USSR Academy of Sciences, have indicated that water could nevertheless be present at the base of the permafrost of the Anabar Shield.

2. The East Siberian hydrogeological folded region includes the vast area embracing the Baikalian and Trans-Baikalian regions, the Baikal-Patoma Highlands and the Stanovoi Range. The surface terrain indicates that this is an intricately constructed mountainous area in which, against a background of highlands and uplands dissected to differing degrees, there are troughs with a variable tectonic nature and also alpine-type ranges with bald peaks, rising to absolute altitudes of between 2000 and 3000 m.

By far the greater part of the region is composed of ancient crystalline and metamorphic rocks. Occupying smaller areas are young volcanogenic and intrusive formations, added to which about 8 per cent consists of normal sedimentary complexes, forming an artesian surface of intermontane basins. According to the period of their formation and their character the latter are divided into three main types: Transbaikalian, Southern Yakutian and Baikalian.

The Transbaikalian-type basins have surface deposits of up to 2000 m in thickness, composed of continental and effusive formations of Jurassic and Lower Cretaceous age. The Quaternary deposits in them are of comparatively slight thickness and do not form artesian water-bearing horizons. Faults framing them may be present on the flanks of the basins.

The Southern Yakutian-type basins have a distinctive tectonic nature, an asymmetrical structure with steep gradients and substantial metamorphization of the rocks at the southern margins and gentle gradients at the northern margins. They are filled with Jurassic coal-bearing deposits of up to 4000 m thick, underlain at the northern margins by Lower Cambrian formations

The southern flank of these basins consists of a faulted zone.

The Baikalian-type basins are connected with major dislocations of the tectonic blocks and combine sunken and graben structures, usually framed by faults and filled with thick series of Quaternary deposits of lacustrine-fluvioglacial and alluvial origin.

The hydrogeological conditions of this folded region are greatly complicated by freezing of the interior, which is highly non-uniform, both in the area and the thickness of the permafrost. The principal mechanisms governing the formation of the permafrost consist in the increase in its overall thickness in the south-north direction. However, this general mechanism is greatly complicated by the altitudinal permafrost zoning. Reflections of this are apparent in the deep freezing of the mountain masses to many hundreds of metres, the decrease in the permafrost thickness and the emergence of discontinuous permafrost on plateaus and highlands that have a relatively depressed surface.

Within the Cis-Baikal Basin and the Lena Plateau, in the area where carbonaceous rocks have formed the permafrost is discontinuous, although its thickness is quite considerable here and amounts to not less than 300 m. The discontinuity of the permafrost in this area is determined by the warming influence of atmospheric precipitation seeping down through various kinds of karst cavities. Even though the talik windows are not of regional importance, an immediate interconnection has formed between the surface and subsurface waters and the conditions for replenishing the resources of subsurface waters are highly favourable. A similar situation can also be observed in the southern part of the Uchur-Maya Uplands, although even greater permafrost thicknesses can be expected there, and the water-absorbing taliks connected with karst cavities are apparently even more localized in area.

Within the Stanovoi Highlands and the northern part of the Vitim Uplands, continuous permafrost predominates. Its thickness is close to 1000 m in the mountain ranges. At times it is even more than this but in the river valleys and intermontane troughs it decreases to 130 m. In the western, Cis-Baikalian part of the Stanovoi Highlands the permafrost thickness decreases to 100 m and less, it becomes more discontinuous and in the immediate coastal strip there are islands of permafrost.

In the southern part of the Vitim Uplands and in the highlands of the Olekma-Range the permafrost thickness decreases to 300-100 m in the mountains. In the south, the watersheds and southerly facing slopes are frequently unfrozen, but in the intermontane areas the permafrost thickness increases to 200-300 m. On the whole, the permafrost is discontinuous here.

Within the Aldan Highlands the permafrost thickness is a direct function of the elevation. At altitudes of more than 900-1000 m the thickness of the continuous permafrost is everywhere greater than 200 m, rising to 800-1000 m on the watersheds.

At lower altitudes it decreases to 50-150 m. The permafrost is discontinuous there. Preeminently discontinuous permafrost also exists on the southern face of the Stanovoi Range and only in the mountain ranges and systems does it at times become continuous again, increasing to 300 m in thickness.

Considering the vastness of the East Siberian hydrogeological folded region, the complexity of the geological and permafrost conditions, and the large number of hydrogeological structures - the artesian basins alone number more than 60 - it seems desirable to describe the hydrogeological conditions according to the types of hydrogeological structures and the particular water-bearing complexes which typify them.

In terms of the conditions of formation of the subsurface waters, hydrogeological masses are subdivided into (a) masses consisting of crystalline and metamorphic rocks, and (b) masses, the upper part of which consists of carbonaceous varieties of rocks.

(a) Hydrogeological masses composed of crystalline and metamorphic rocks are, in the hydrogeological sense, likewise non-uniform. The conditions under which their subsurface waters form are in many respects dependent on the character of the permafrost. Here, much is determined by the relation between the permafrost thickness and the thickness of the zone of regional fissuring, which in rocks of this kind is normally confined to the first 100 m; by the conditions of drainage and freezing; and by the discontinuousness of the permafrost. On the basis of these conditions the following types of hydrogeological masses are envisaged.

Hydrogeological masses expressed in the relief by mountain structures, deeply dissected and situated in continuous permafrost, the thickness of which is not less than 300-400 m and exceeds the thickness of regional fissuring.

Such conditions are typical of the hydrogeological structures of the Stanovoi Highlands and the northern part of the Vitim Uplands, within the Aldan Highlands at altitudes of more than 900 m, in the watershed region of the Stanovoi Range, and possibly in the watershed regions of the Yankan-Tukuringra-Dzhugda ranges and the mountainous area formed by the Turun-Bureya and other ranges.

Within hydrogeological masses of this type, the subsurface waters do not have a regional distribution. They occur solely in the bottoms of river valleys where they form in unconsolidated alluvial, fluvio-glacial or other valley deposits and in the fissured zone in the underlying bedrock. The fact that under these conditions the zones of increased fissuring of crystalline and metamorphic rocks are confined specifically to river valleys is due to two considerations. Firstly, to the selective eroding action of the river current, which is greatest precisely in rocks with a high degree of fissuring and a lowered resistance to weathering agents, and secondly, to the processes of cryogenous reworking of the crystalline and metamorphic rocks during the

formation and development of the permafrost. Since fissuring, in its turn, normally increases in zones of tectonic dislocations, the river valleys here are often arranged along the fault zone or zones of rupture dislocations feathering them.

Stable water-bearing horizons in the alluvial and fissured rocks underlying the bottom of a river valley can only form when the hydraulic and thermal energy of the flow is sufficient to create a large supraperafrost or open talik. Actually, such flows only originate where the drainage systems are of a certain area. Usually, this is between 50 and 200 square kilometers but in some cases, it may be larger. Thus, in the watershed regions of these masses, subsurface waters are unlikely to occur, even in the river valleys.

Another important factor affecting the formation of a talik and a dependable talik water-bearing horizon in a valley are the geological conditions under which unconsolidated deposits accumulate and the character of the latter. First and foremost, this means the thickness of these deposits and their cross-section, the water permeability, the seepage coefficients and the changes in these parameters along the valley. As a rule, in the mountain valleys of Eastern Siberia and within the area being considered, these parameters also vary appreciably along the river valleys. In particular, changes are observed in the thickness of the unconsolidated deposits and their depth across the valley, right down to the point where they wedge out. The intensity and depth of the fissuring zones also change, as do the seepage coefficients of the alluvial deposits. Ultimately, a change occurs in the potential capacity of the water-bearing horizons under the river bed, and consequently, in the natural resources of the subsurface waters forming in this space when it is in the unfrozen state.

One must also bear in mind that in valleys with extensive development of icings the processes leading to icing formation are conducive to a decrease in the reserves of subsurface waters during the period when water supply is critical.

The hydrogeological masses, expressed in the relief by mountains of intermediate height, plateaus and relatively weakly dissected uplands, are situated in continuous or discontinuous permafrost. Its thickness is from 100 to 300 m. Very occasionally it is greater and may approximate to or be less than that of the zone of regional fissuring. Such conditions are typical of the hydrogeological structures of the southern part of the Vitim Uplands, the Olekma Range, the Aldan Highlands at elevations less than 900 m, the southern slopes of the Stanovoi Range, and a considerable part of the area containing the Yankan-Tukuringra-Dzhagda ranges and other mountain structures.

Within hydrogeological masses of this kind the subsurface waters have a regional distribution by virtue of the more favourable conditions of recharge through open taliks and because of the emergence at the permafrost base of a zone of cryogenous disintegration and deep weathering, caused by repeated freezing and thawing of fresh water in the rock fissures. All

the same, in these structures also the water-bearing capacity of the crystalline and metamorphic rocks away from the river valleys is extremely slight.

(b) Hydrogeological masses of which the upper part is composed of carbonaceous rocks are much less widespread. They occur mostly in the eastern part of the region. In terms of their hydrogeology they have hardly been studied at all. Nevertheless, the large number of icings recorded on the tributaries of the Gonam and Uchur rivers, and also the high water-bearing capacities of the karst horizons of the Uchur-Maya artesian basin and the many forms in which active karst processes are manifested, are indicative of the high potential water-bearing capacity of the carbonaceous rocks of hydrogeological masses. Newly formed karst sinkholes are also indicative of the discontinuous nature of the permafrost within hydrogeological masses composed of carbonaceous formations.

On the basis of the conditions of formation of the subsurface waters, artesian basins are subdivided into (a) intermontane and (b) median.

Besides the geostructural indicators, the conditions of formation of the subsurface waters of the artesian basins of this region are in many respects determined by the permafrost situation. First and foremost this means the discontinuousness and thickness of the permafrost, the relation between the permafrost thickness and the thickness of the sedimentary surface of the basin and its constituent water-bearing complexes, and the thickness of the fresh water zone. Here, the following relations exist:

1. Basins in which the permafrost thickness is less than the thickness of the sedimentary surface and the upper water-bearing complex and less than the thickness of the fresh water zone. This applies to the Barguza, the Upper Chara and the Upper Angara intermontane basins and certain others. These are the most favourable hydrogeological structures for the formation and utilization of fresh subsurface waters.

2. Basins in which the permafrost thickness is greater than the thickness of the upper water-bearing complexes, but less than the thickness of the fresh water zone. Included among these basins are the Yukhtino-Yllymakh, in which the Jurassic water-bearing complex is completely frozen, and many small artesian basins confined to the mountain troughs of the Olekma Range and Vitim Uplands, where the Genozoic deposits are essentially frozen and subpermafrost water-bearing horizons occur only in rocks of Mesozoic age. The permafrost conditions of these basins predetermine their exceptional recharge on account of the overflowing of waters from the hydrogeological masses along the fissured zones and the faults framing them.

3. Basins in which the sedimentary cover is completely frozen. There are very few of these in the region being discussed. They are the minor structural depressions of the

Aldan Shield which are filled with Jurassic coal-bearing deposits. The largest is the Gonam Basin.

Thus, in considering the overall effect of deep freezing of the interior on the hydrogeological conditions of the artesian basins, it should be noted that in the vast majority of cases the freezing of artesian structures does not rule out the presence of and potentialities or utilizing subsurface waters of the sedimentary surface, although replenishment of the water resources is hampered and the natural reserves of these tend to decrease because of the frozen part of the potentially water-bearing rocks.

3. The Verkhoyansk-Chukotsk hydrogeological folded region is a highly complex geostructural formation, within which are distinguished the Yana-Kolyma and Anyuisk-Chukotsk folded systems and the Okhotsk-Chukotsk volcanogenic belt.

The Yana-Kolyma folded system includes the Verkhoyansk anticlinorium, which is expressed morphologically by a chain of mountains composed preeminently of terrestrial formations of Permian and Carboniferous age. The Sette-Deban horst-anticlinorium, which also includes carbonaceous rocks of Lower and Middle Paleozoic age, and the vast Yana-Sugoi synclinal zone, expressed by uplands of the same name which pass into deeply dissected highlands towards the south. Further east is the Kolyma median mass. On the north and southwest it is framed by the Moma-Polousnyi anticlinal zone, typified by intensive block tectonics and the contrasting character of the neotectonic movements. The central structure framing the Kolyma mass is the Moma-Selennyakh rift depression. Extensively occurring in these structures are terrestrial and volcanogenic formations of Mesozoic and Upper Paleozoic age, carbonaceous karst rocks of Middle Paleozoic age and also granitoid bodies, usually forming watershed upland areas.

The complex geological structure is emphasized by the intricately built relief of the Yana-Kolyma folded system, a combination of plateaus and high alpine-type watersheds and intermontane depressions, confined to the river valleys. Only within the sunken part of the Kolyma mass does the relief become smooth, when it passes into an inclined coastal lowland.

The Anyuisk-Chukotsk folded system is a mountainous region that includes folded highlands, areas of medium altitude and horst-block relief, connecting with depressions and rolling aggradational plains. The system is composed predominantly of terrestrial and volcanogenic-terrestrial folded formations, mostly of Mesozoic and Upper Paleozoic age, and to a much lesser extent of carbonaceous and intrusive rocks.

Predominating in the Okhotsk-Chukotsk volcanogenic belt are volcanic plateaus and highlands, composed of preeminently neutral and basic effusives that have overlapped the intricate block structures beneath their base.

The overall tectonic plan of the entire area comprising the Yana-Chukotsk hydrogeological folded region is extremely non-uniform and consists of regions with a relatively stable neotectonic regime (the Kolyma median mass) that are subject to slow, gentle subsidence and of regions subject to poorly contrasted neotectonic uplifts (the Yana-Sugoi and Oloi synclinal and the Anyuisk anticlinal zones), and finally, of regions of highly contrasted neotectonic block movements of great amplitude, trending towards the zone where the Moma-Selennyakh rift originated (12). A number of the structures occupy an intermediate position in terms of the activity of the neotectonic processes.

So complex is the morphological, geological and tectonic structure of the Yana-Chukotsk hydrogeological folded region that it has even predetermined the complex permafrost conditions. Over almost the entire region the permafrost is continuous and its thickness increases in the mountains, attaining values of 400-600 m and more beneath the watersheds, while in the troughs it decreases to 200-400 m. Only in the approximately 200 km wide coastal tract of the Sea of Okhotsk does the permafrost assume at first a discontinuous character and subsequently one of islands. Gradually, the hydrogeological structure lose all semblance of their specifically permafrost nature.

After considering the influence of the deep freezing of the interior on the hydrogeological structures of this part of Eastern Siberia it can be stated that here, the freezing processes have affected for the most part hydrogeological masses of varying composition, tectonic and morphological structure.

On the basis of tectonic structure and neotectonic characteristics, the following are distinguished among the hydrogeological masses (HM):

(1) horst-anticlinoria, highly disturbed tectonically and broken into individual blocks corresponding to the zones of contrasting neotectonic movements. They include the Cherskii Range HM, the Sette-Daban HM, and the Omulevka HM;

(2) anticlinoria and anticlinal zones corresponding to major monolithic uplifts. They include, in particular, the Verkhoyansk, Moma and Kolyma masses and numerous masses of the Anyuisk-Chukotsk folded zone;

(3) synclinoria and synclinal zones corresponding to weak, undifferentiated uplifts and expressed in the relief by relatively weakly dissected plateaus and highlands. They are the Yana-Sugoi synclinal zone, the Oloi synclinal zone and certain others.

Morphologically, the HMs belong to high alpine-type structures, medium altitude and low mountain structures and plateaus and highlands dissected to varying degrees.

Depending on the composition of the rocks, all of the masses can be subdivided as follows: masses consisting of carbonaceous and terrestrial-carbonaceous, terrestrial and volcanogenic-terrestrial, and crystalline and metamorphic rocks.

It is obvious from the foregoing that both the morphology and the geological structure of the HMs of this area are highly diverse. The character of a hydrogeological structure, as a natural reservoir of subsurface waters, is further complicated by the freezing processes as such and by the altitude belt patterns of the permafrost. Thus, even those structures which are unique in the morphostructural and tectonic sense proved to have highly dissimilar permafrost-hydrogeological characteristics in various parts of them. Nevertheless, we shall examine this in greater detail, concentrating our attention on the regional consequences of the freezing processes.

In considering the HMs of the first type it should be noted that the highly contrasted nature of the most recent of the block tectonic movements has led to some very important permafrost-hydrogeological consequences of the rearrangement of their structural plan. We are speaking firstly of the freezing of "unhealed" faults, and secondly, of narrow valley-like grabens and ancient buried valleys filled with thick series of coarse sandy-pebbly deposits. Both consequences of the recent block tectonics have led to the formation within these structures of highly water-saturated zones which are dependable paths for the interlinking of the subsurface and surface waters. This is traced especially clearly in HMs composed of carbonaceous and terrestrial carbonaceous rocks, actively karsted along zones of regional faults and where these intersect with feathering faults. Thus, the overall permafrost-hydrogeological structure of HMs such as these appears to be as follows: occurring within the thick permafrost are highly saturated intrapermafrost taliks, confined to the fissured zones of faults and buried in presently existing river valleys filled with thick series of gravel and boulder deposits. These taliks usually intersect and at the points of their intersection conditions originate which are most favourable for the discharge of surface waters or for their overflow from one saturated zone into another. Sometimes this results in a non-alignment of the watersheds of the surface and subsurface waters, in enhanced water exchange activity, which has been estimated for some of the hydrogeological masses by means of isotopic analyses of the subsurface waters (13), and also in high readings of the relative iciness values, which in these structures are as much as several percent.

At the permafrost base the water conductivity of the rocks is also extremely non-uniform. It increases in fault zones where there is evidence of tension and decreases in the blocks enclosed between these faults. Within the most deeply frozen watershed, where they are composed of monolithic rocks, sub-permafrost waters may be non-existent or present in amounts of no practical significance.

The hydrogeological situation just described is especially typical of the HMs of the Cherskii Range.

The HMs of the second type, consisting of large monolithic uplifts, are distinguished from those of the first type by the more undisturbed tectonics and for this reason the fault zones cease to play the decisive role that they do in the HMs of the first type. Accordingly, in the permafrost-hydrogeological plan, talik zones connected with river valleys and the warming effect of the watercourses begin to play a leading role. In section, these talik zones normally have a two-stage arrangement; the upper stage is composed of alluvial deposits, the lower stage - of the subjacent fissured terrestrial, crystalline or metamorphic rocks. As river valleys have a tendency to inherit the most slackened zones and are frequently confined to faults, it is precisely along the valleys that there is an increase in the water conductivity of the bedrock and conditions are originated and sustained which favour the migration of subsurface waters and the preservation in the unfrozen state of the reservoirs containing them.

The morphology of the valley taliks is fairly complex. As a rule, along the valley of a river there is an alternation of subpermafrost taliks and open taliks. In the valleys, however, the permafrost is normally much thinner than beneath the neighbouring watersheds and conversely, the degree of fissuring of the rocks is greater. This situation leads to a relative increase in the water conductivity of the subpermafrost fissured zone in river valleys as compared to watershed expanses. There, the zone of regional fissuring (weathering) is usually completely frozen. Ultimately it leads to the separation of a single water-bearing system of HMs, to localization of the water conductivity of the rocks along the river valleys, and to the formation of pressure head systems delimited by the areas of the river basins.

Nevertheless, the permafrost-hydrogeological characteristics of the structures being described are not limited to these. The convective nature of the talik zones predetermined the decisive role of altitudinal zoning in the distribution of subsurface waters. Actually, for initiating the formation and stable development of taliks, including the open taliks needed for the recharging of subpermafrost waters, a sufficiently powerful heat flux and consequently a watercourse is required. The latter can only form when the drainage area is of a certain magnitude. On the average, this ranges from 50 to 200 km² for the HMs of the Verkhoyansk-Chukotsk hydrogeological folded region. In the areas framing the watershed expanses there are no taliks and the permafrost thickness is at a maximum, as is the drainage capability of the rock mass. Taken together, all this is indicative of the highly problematic nature of efforts to detect appreciable quantities of subpermafrost waters within watershed expanses. Moreover, as the thickness of the watercourses, and consequently of the potentially water-bearing alluvial deposits as well, increases in the downhill direction, so also do the parameters of the talik zones increase in this direction. This means that the abundance of water in the rocks of the HMs in the regional

plan also increases. Thus, the morphology of an HM that has become deeply and continuously frozen determines the character and water abundance of the HMs in two ways: through altitudinal zoning and through the pattern (morphology) of the river drainage.

Consequently, the permafrost factor, superimposed on the geological structure, combined with the morphological plan of the HM, together determine the specific character of the hydrogeological structure of an expanse containing HMs. However, when icing control is being undertaken, these considerations also predetermine in many respects the hydrologic cycle governing the formation of the subsurface waters.

The variability of the cross-section of the taliks and the non-uniformity of the seepage properties of the rocks making up the water-bearing talik zones of river valleys, which is caused by the change in the lithological composition of the alluvial or subjacent bedrocks, leads to variation of the water conductivity along the length of the talik zone, which is highly typical of the HMs of the Verkhoyansk-Chukotsk hydrogeological folded region. This phenomenon, in turn, leads to the following situation: in areas where there is a relative decrease in water conductivity, a discharge of intrapermafrost waters, and in the open taliks - of subpermafrost waters as well, takes place into the river valley, so that they replenish the resources of the surface runoff. But in areas where there is a relative increase in the water-conductivity of the talik zones an opposite phenomenon ensues. In summer, the reciprocal action between the surface and subsurface currents under these conditions is observed as a constant fluctuation in the flow rate, from section line to section line, although there is a tendency for it to increase in the downstream direction. But in winter, with the prevailing low temperatures, in the areas where the subsurface waters are discharged, icing formation processes begin to develop, immobilizing the subsurface waters and removing them from circulation until the following spring and summer. In this case, a consequence of the icing formation process is a decrease in the natural resources of subsurface waters and accordingly, a decrease in the levels of the latter. Consequently, along with the non-uniformity in the spatial distribution, it is also valid to speak of the seasonal non-uniformity in the distribution of the subsurface waters of these permafrost-hydrogeological structures. Typical representatives of such structures are the Verkhoyansk HMs, the Anyuisk hydrogeological AdMs and a number of smaller structures of lesser importance.

Somewhat different consequences of the formation of the permafrost originated in structures which, in the character of their constituent rock material, closely resemble hydrogeological masses or admasses, but in terms of the relief are manifested as plateaus, where the depth to which the river valleys are incised is comparable to the permafrost thickness (HMs of the third type). The fluctuations of the permafrost base during the course of its formation and development have led to what is akin to deep frost weathering in the disintegration of the

permafrost. This relatively shallow weathered zone, amounting to a few metres in thickness, or rarely, several tens of metres, is a main water-bearing zone, interconnected with the surface through the talik windows of the valleys. Consequently, under certain conditions, the permafrost processes leading to the freezing of the substantial reservoirs afforded by the artesian structures and disconnecting the single pressure-head system of the HMs, are a factor in the formation of a water-bearing zone and in the determination of its water conductivity and the pressure head characteristics of the waters contained in it. In other words, they are a genetic factor in the formation of the permafrost hydrogeological structure. This makes it possible to define them as cryogenous basins of pressure fissure waters. Within the Verkhoyansk-Chukotsk hydrogeological folded region the largest of these are the Yana-Sugoi, the In'yali-Debin and the Ol'dzho basins.

Similar consequences of deep freezing can also be noted in the case of other structures of the Okhotsk-Chukotsk volcanogenic belt, the thickness of whose volcanogenic surface materials exceeds both the depth to which the river drainage is incised and the permafrost thickness. One can only assume that at the base of the latter some kind of primary contractional fissured state, characteristic of effusive rocks, is developed, and consequently, even under the conditions generated by the deep freezing, the volcanogenic superbasins have preserved their regional water abundance.

In addition to the hydrogeological masses and the volcanogenic superbasins that make up the main part of the Verkhoyansk-Chukotsk hydrogeological folded region, artesian structures of the platform type and especially those of the intermontane type have formed in considerable numbers. The hydrogeology of the artesian basins of the platform type, and also that of the Kolyma and the East Siberian Sea, has not been studied. It can only be assumed that at the permafrost base of these structures there are some weakly brackish and low-pressure water-bearing complexes. The intermontane artesian basins have been relatively well studied.

The structural position of the intermontane ABs is such that they are confined to grabens and superimposed structural basins or to temporary river valleys and erosional basins. Depending on the composition of the sedimentary surface, a distinction is made between basins whose surface is composed exclusively of Neogene - Quaternary deposits, and ABs whose surface consists for the most part of Mesozoic terrestrial and coal-bearing deposits of preeminently Upper Jurassic - Cretaceous age.

Depending on the relation between the thickness of the surface deposits and the permafrost thickness, the intermontane ABs of the Verkhoyansk-Chukotsk hydrogeological folded region are subdivided into two groups: ABs, the thickness of whose surface deposits is greater than that of the permafrost, with the result that the ABs have preserved the principal feature which is typical of these structures - the presence of stratal

pressure waters in the rocks of the sedimentary surface - and ABs, the thickness of whose surface deposits is less than that of the permafrost. Accordingly, these structures no longer display the principal feature of artesian structures and are defined as cryogeological basins, that is to say, basins which are frozen throughout the entire thickness of the sedimentary surface.

Cryoartesian basins containing a completely frozen belt of fresh subsurface waters are also present in the coastal areas of the Verkhoyansk-Chukotsk hydrogeological folded region.

The discontinuity and the depth of freezing of the intermontane ABs do not only determine the character of the hydrogeological structure and the hydrochemical section. They also determine in large measure the conditions of recharge of these structures. In actuality, the water bearing horizons of the ABs of the permafrost islands or discontinuous permafrost, the Singlanskii, the Lankovskaya, the Yama and the Paren', are able to receive a steady recharge on the limbs of the structures, through the overflow of subsurface waters from the upper fissured zone of the hydrogeological masses directly into the horizons of the sedimentary surface. Where there is continuous permafrost of great thickness this fissured zone is completely frozen. Moreover, in the peripheral parts of the ABs and on the limbs of the HMs, as a result of the freezing processes a wedging out of the taliks and the subsurface waters enclosed in them is frequently observed, and thick lines of discharge of the subsurface waters immobilized by icings originate. This is exemplified in the peripheral parts of the ABs of the Moma-Selennyakh system of basins, in the Rauchuvan AB and in a number of others. Consequently, in a number of cases the recharge of the artesian basins from the direction of the hydrogeological masses framing them is impeded. It does appear to be possible in the basin-grabens along the framing tectonic zones, and in other cases, by way of the relatively sparse talik windows or the pressure head waters of the basement.

4. The Kamchatka-Koryakh hydrogeological folded region extends into the northern, Koryakh part of Eastern Siberia. Its western boundary is the boundary of the Okhotsk-Chukotsk volcanogenic belt. In the eastern part, the structures of the region extend beneath the level of the Bering Sea.

Within that part of the region which we are considering, two major systems of hydrogeological structures are distinguished; in the west, the Penzhino-Anadyr' artesian region, and in the east, the Koryakh system of hydrogeological masses and volcanogenic superbassins.

The Penzhino-Anadyr' artesian region extends from the Anadyr' Gulf on the Bering Sea westward and southwestward to the Penzhino Gulf in the Sea of Okhotsk and includes several contiguous artesian basins, the surface of which consists of Cenozoic deposits, partly separated from one another by hydrogeological masses. With the exception of the Penzhino AB,

all of the Abs of this region are frozen to great depths. The permafrost is mostly continuous, but beneath the lakes and along the valleys there are persistent open taliks. These ensure water exchange between the surface and subsurface waters and the formation of a fairly thick subpermafrost zone of unimpeded water exchange. This is very largely due to the centres of recharge of the artesian basins of this region greatly surpassing the centres of discharge. Moreover, only in the coastal zones do brackish waters occur immediately beneath the permafrost.

The Koryakh system of hydrogeological masses and volcano-genic superbasins is typified by the presence of preeminently Cretaceous and to a lesser extent, of Middle Paleozoic terrestrial, highly dislocated and silicified rocks forming the mountains of the Koryakh Highlands. In tectonic outline these highlands exhibit a block structure. In the most sunken blocks, which are filled with Paleogene - Neogene and Quaternary deposits, artesian basins, often linear shaped and with hanging valleys, have formed. A part of the artesian basins is known to be in the Bering Sea.

Almost no permafrost studies have been conducted in the central part of the Koryakh Highlands. Along the coast the permafrost is discontinuous. It can be inferred from the distribution of the icings that the permafrost-hydrogeological situation in the greater part of the HMs of this region is similar to that of the remaining hydrogeological structures of the North-East. Nevertheless, considering the climatic differences, there ought to be a somewhat larger number of taliks here, they should be more stable in plan and in section and consequently, provide for better conditions of reciprocal action between the surface and subsurface waters and for the replenishment of the latter.

In concluding this description of the permafrost-hydrogeological zones of the Verkhoyansk-Chukotsk and Kamchatka-Koryakh hydrogeological folded regions, we cannot avoid mentioning that the classification of some of the structures that have been distinguished is tentative and in the nature of a prediction. This is because they have not yet been adequately studied. It applies particularly to the cryogenous basins of the pressure-fissure waters, certain of which have been included among the adartesian basins by a number of authors (14). It cannot be ruled out that some of the intermontane artesian structures are also closely similar to adartesian structures by virtue of the substantial lithogenesis of the rocks constituting their surface and because of the predominant role of fissuring in the shaping of the water conductivity of the hydrogeological section. Finally, given the existence of continuous permafrost of great thickness, by no means all of the details of the recharging of the intermontane and platform type artesian structures have as yet been ascertained. Many of the theories pertaining to the recharging of subsurface waters are presently in the nature of hypotheses.

Conclusions

From the foregoing discussion of the hydrogeological regions of Eastern Siberia it is possible to discern radical changes that have been wrought in the hydrogeological structures as a result of their freezing to great depths and through the development of the permafrost as such. In summarizing the results of the discussion it can be noted that the consequences of deep freezing of the interior are different in the case of artesian basins and hydrogeological masses. These differences in the nature of the change in the water-bearing properties and also other characteristics of the two main groups of hydrogeological structures comprising artesian basins and hydrogeological masses are considered in the main body of the report.

The changes that occurred in the hydrogeological structures necessitated the development of special techniques for studying the permafrost-hydrogeological conditions. These range from remote-controlled aerospace and geophysical studies to detailed hydrogeological surveys and the search for and exploration of subsurface waters. References to these techniques are contained in a number of monographs and special instructional manuals. They are also being used in numerous studies currently in progress. Many of the problems are the subject of continuing discussion. One of them in particular is the purpose for which hydrogeological mapping is carried out. The traditional mapping of a water-bearing stratum, horizon or complex is suited to the permafrost free situation. But under the conditions presented by continuous permafrost, which entails the differentiation of the section into suprapermafrost, intrapermafrost and subpermafrost waters, it clearly fails to meet the theoretical requirements of the survey, nor does it provide for the practical utilization of the information that has been derived.

A strengthening of the interconnection between the surface and the subsurface (subpermafrost) waters through talik windows and zones has occurred as a result of the freezing of the hydrogeological masses. This has made it possible to narrow down the question of the special conditions which must be satisfied in order to preserve the subsurface waters and to emphasize the need for upgrading the requirements for preserving the surface waters in the permafrost-hydrogeological regions of Eastern Siberia. Conversely, in artesian structures, thick continuous permafrost offers reliable protection of the subsurface waters against pollution and makes it possible to use the subsurface waters (when their properties and resources are satisfactory) as a principal source of potable water.

These and many other questions pertaining to the theory and practice of permafrost hydrogeology will be more easily resolved with the publication of the map of the permafrost hydrogeological zoning of Eastern Siberia which is currently in the course of production. The principles that were used in the compiling of this map and the schematics of the permafrost zoning are elucidated in the present report.

REFERENCES

1. Hydrogeology of the USSR, composite volume No. 1. Principal mechanisms in the distribution of the subsurface waters of the USSR. Moscow, "Nedr" publishing house, 1976, 656 pp.
2. Tolstikhin, N.I., and Tolstikhin, O.N. Subsurface waters of the permafrost zone in the USSR. Main results and problems of the study. 2nd International Conference on Permafrost. Papers and speeches, Vol. 8, Yakutsk. Yakutsk book publishing house, 1975, pp. 73-87.
3. Zaitsev, I.K., and Tolstikhin, N.I. Principles of the hydrogeological zoning of the USSR. Data derived from regional and exploratory hydrogeology. Leningrad, Publishing house of the All-Union Scientific Research Geological Institute, 1963, pp. 5-34.
4. Tolstikhin, N.I., and Tolstikhin, O.N. Cryogenesis and water-bearing properties of hydrogeological structures. Essays on the hydrogeology of Siberia. Novosibirsk, "Nauka" publishing house, Siberian Branch, 1973, pp. 21-29.
5. Pinneker, E.V. Problems of Regional Hydrogeology. Mechanisms governing the distribution and formation of subsurface waters. Moscow, "Nauka" publishing house, 1977, 196 pp.
6. Kononova, R.S. Hydrochemical zoning of subsurface waters as one of the indicators of paleopermafrost conditions. 2nd International Conference on Permafrost, papers and reports, Vol. 5. Yakutsk. Yakutsk book publishing house, 1973, pp. 90-94.
7. 2nd International Conference on Permafrost. Papers and reports, Vol. 5. Yakutsk. Yakutsk book publishing house, 1973, 127 pp.
8. Anisimova, N.P. Development of the Chemical Composition of the Subsurface Waters of Taliks, as exemplified by Central Yakutiya. Moscow, "Nauka" publishing house, 1971, 195 pp.
9. Aspects of the Hydrogeology of Permafrost. Collection of transactions of the Institute of Permafrost, Siberian Branch of the USSR Academy of Sciences, Yakutsk, 1975, 174 pp.
10. Hydrogeology of the USSR. Yakutsk ASSR, Vol. 20. Moscow, "Nedr" publishing house, 1970, 383 pp.
11. Solov'eva, L.N. Morphology of the Permafrost of the Sayano-Baikal Region. Novosibirsk, "Nauka" publishing house, Siberian Branch, 1976, 126 pp.

12. Afanasenko, V.E., and Naimark, A.A. Icing formation and neotectonics of the Moma rift region (North-East of the USSR). *Sovetskaya Geologiya*, 1977, Np. 4, pp. 66-77.
13. Afanasenko, V.E., and Morkovkina, I.K. Age of the subsurface waters beneath the Tas-Khayakhtakh Range and the Selennyakh Superbasin. *"Vestnik MGU, ser. geol."* 1973, pp. 105-109.
14. *Hydrogeology of the USSR, Vol. 26. North-East of the USSR.* Moscow, "Nedr" publishing house, 1972, 295 pp.

INTERACTION BETWEEN PERMAFROST AND BUILDINGS

S.S. Vyalov¹

Abstract

The main task of the theory of construction on permafrost is to study the principles governing the interaction between permafrost and buildings erected on them, and to work out methods for controlling this interaction. Practical methods for using permafrost as a foundation for buildings, developed and tested in construction practice, are being realized in the U.S.S.R. as specified in the Construction Standards and Regulations (SNIIP). A new edition of the SNIIP chapter on the design of beds and foundations on permafrost was issued on 1 January 1978. It contains the theoretical and practical achievements of foundation construction on permafrost accumulated since the previous issue (in 1966).

The interaction between permafrost and buildings consists of thermal and mechanical action of buildings on permafrost on the one hand, the settlement of ground under the load of buildings and on the stability and strain of building structures on the other. Using the thermodynamic approach, it is possible to establish a relationship between the work of deformation of the bed, which is caused by the load of the building, the heat flux from the building, and the increase in intrinsic energy and entropy. Complementing this relationship with the thermal flow equation and the rheological equation of state, it is possible to obtain functions which determine the strain and creep limit of the base. One can also take into consideration the variable temperature regime of the ground caused by the thermal influence of the building and its variable load. It is then possible to examine the combined work of the ground and building. Such considerations should become the basis for the solution of problems involving interaction between permafrost and buildings. Some of the above considerations are already being used at the present time, notably in the new SNIIP chapter. This paper examines the positions taken in that chapter.

1 Scientific Research Institute for
Foundations and Underground Structures,
Moscow, U.S.S.R.

As before, two principles are accepted as basic aspects for the utilization of permafrost as a foundation, i.e. the preservation of the frozen state of the ground (principle I) and allowing such grounds to thaw during the construction and use of the building or prior to the erection of the building (principle II). The foundation analyses have improved considerably. These calculations are carried out for two limiting states, i.e. strength (for principle I) and strain (for principle II, and for principle I in the presence of plastic-frozen or ice rich ground). Moreover, the calculations take into consideration the rheological properties of the soils. The design values based on strength characteristics of permafrost are improved considerably. Construction of and design methods for foundations under high loads are stipulated.

A new approach is accepted for the calculations of thaw subsidence of beds which takes into consideration the presence of the permafrost layer, regarded as a rigid bed, which underlies the compressed thawed layer of the ground. A method for determining the reactive pressures of the thawed ground on the foundation is proposed, and the question of considering the combined action of the thawed bed and building structure above the ground is examined.

Particular attention is devoted to methods of controlling the thermal regime and mechanical properties of permafrost by means of preliminary refrigeration in case of "high temperature" permafrost, intermittent freezing, etc., or on the contrary, by means of preliminary thawing of beds in the case of ice saturated permafrost, which results in greater thaw subsidence, and when it is not possible to apply principle I.

In applying principle I to the utilization of permafrost beds it is accepted to assign a certain value to the design temperature of permafrost instead of using its naturally occurring temperature. In the case of plastic frozen grounds this design temperature may be lower than the natural temperature and, according to SNiP requirements, refrigeration must be applied in this case; or it may be higher if there is a temperature variation in the ground. Measures are proposed for maintaining such design temperatures of the ground; also methods for the combined calculation for the thermal-technological state of the building and the thermal regime of the ground are put forward, and in particular methods for the design of ventilated basements, cold first floors, and cooling pipes and ducts.

The application of the standard has been expanded considerably. The application of the new SNiP is now spreading to permafrost types which are not favourable to construction, such as salty, peaty, ice rich (including ground ice) permafrost as well as permafrost in regions of high seismic activity. Special design measures and methods have been worked out to ensure stability of structures erected under such permafrost ground conditions. Design characteristics (thermo-physical and mechanical) for such conditions are given.

Definition of the Problem

The study of the principles governing the interaction between permafrost and structures erected on them and the elaboration of methods for controlling this interaction constitute the main problems of construction in permafrost. The theoretical treatment of this problem and practical solutions of the utilization of permafrost as bases of structures are being realized in the USSR as specified in the standardization document Construction Standards and Regulations (SNIIP). A new version of the SNIIP chapter on the design of bases and foundations in permafrost was issued recently (SNIIP, 1976). The purpose of this paper is to describe the principles upon which the new SNIIP chapter was based and report on the achievements of foundation construction on permafrost accumulated in the interim.

The Thermodynamic Approach

Before beginning the discussion of the above questions I shall look into certain general theoretical considerations which I consider to constitute the theoretical basis of the next phase in the solution of this problem, despite the fact that they are not fully applied in permafrost construction yet.

Thermal physics, physical chemistry, and mechanics of permafrost and ice are known to constitute the theoretical basis of construction on permafrost. It so happened, however, that all these three disciplines have developed independently. Despite great achievements in each of the three areas, the solution of the overall problem was not advanced because of the isolation existing between them.

On the one hand the interaction between buildings and permafrost consists of a thermal and mechanical (ie forces) action of buildings on the ground which creates a thermal gradient or a stress field, differing from that occurring under natural conditions. The change in temperature causes a change in the physical and mechanical properties of the ground, and the additional (to the natural) stresses deform the ground, and the deformation is particularly high in cases where the temperature increase exceeds the melting point. In its turn, the ground settlement causes deformation in the building structure. This is the essence of the action of the ground on the building. Thus, thermal and mechanical actions are interrelated. The best approach would be one which examines thermal, mechanical, and physical processes in combination with each other and obtains equations which interrelate these processes. Such an examination is possible within the field of thermodynamics, since this is precisely the science which concerns itself with the study of mutual reaction between thermal and other forms of energy, the mechanical being one of

them. Thus, the first and second laws of thermodynamics provide the following relationship which relates the thermal and deformation processes:

$$\theta dS \geq dE + \delta A, \quad (1)$$

where, θ is the absolute temperature (K), dS is the entropy increment, dE is the increment of the intrinsic energy, $\delta A = \sigma_{ij} \delta \epsilon_{ij}$ is the increment in the strain deformation work ($ij = 1, 2, 3$). It should be noted that in its turn the deformation work $A = A^e + A^p$ consists of the elastic work $A^e = \sigma_{ij} \delta \epsilon_{ij}^e$ and the dissipated work $A^p = \sigma_{ij} \delta \epsilon_{ij}^p$, where, ϵ_{ij}^e and ϵ_{ij}^p are the components of the reversible (elastic) and irreversible (plastic, viscous) strains. Therefore, the entropy increment may be regarded as the summation $dS = d\epsilon^e + d\epsilon^p$, where $d\epsilon^e = \frac{dQ}{\theta}$ is the external entropy increment resulting from the external thermal flux Q , and $d\epsilon^p$ is the internal entropy increment of the body resulting from the dissipation of energy, ie the result of the conversion of the kinetic energy of irreversible deformation to thermal energy, and also that resulting from changes in the microstructure of the body due to its deformation.

In order to complete the system of equations, the law of conservation must be complemented by determinant equations, ie state equations. One of them is the Fourier law, which relates the thermal flux q to the temperature gradient

$$q = \lambda \text{grad } \theta, \quad (2)$$

where, λ is the coefficient of thermal conductance. Another such equation is the rheological equation of state which establishes a relationship between the components of the tensors of stress, strain and of their velocities, and also time and temperature.

$$P(\sigma_{ij}, \dot{\sigma}_{ij}, \epsilon_{ij}, \dot{\epsilon}_{ij}, t, \theta) = 0 \quad (3)$$

The thermal conductance equation

It is known that the equation for convective thermal conductance, which can be used to determine the temperature distribution in the ground, can be obtained from equation(2). Moreover, it is possible to account for the phase transformations of the water contained in the ground by introducing into the equation the heat content per unit mass (enthalpy) H_e , as was shown by N.A. Buchko (see the paper of V.A. Makarov et al in the proceedings of the 7th Section of this conference, 1978 papers),

$$\frac{\partial H_3}{\partial t} = \text{div}(\lambda \text{grad } \theta), \quad (4)$$

where,

$$H_3 = \int_{\theta_1}^{\theta_2} C_{3\varphi}(\theta) d\theta. \quad (5)$$

$C_{3\varphi}(\theta)$ is here the effective thermal capacity which takes into account both the thermal capacity of the ground and the latent heat of the ground moisture.

The rheological equation of state

In order to develop equation (3) it is necessary to know the laws relating the components of stress and strain or of their velocities. As a rule such laws are established by empirical means, in such a case they possess a phenomenological quality and are true only for specific conditions and within specific limits. The state equation would be more general if the initial relationships between the components of stress and strain (and temperature) could be derived from a consideration of the physical essence of the process, on the basis of the kinetic theory of strain and longtime failure, for instance (Vyalov, 1978).

According to this theory the ground may be regarded as a chaotic combination of elementary particles, mineral grains and their aggregates held together by ice, and pockets of non-frozen water. In order to displace such elements, they must be supplied with the activation energy U , the greater part of the energy of inter-particulate bonds. Since the sizes of the elements are always much smaller than the volume of any ground considered, it is possible to apply the methods of statistical physics and to consider that the probability for the particles to obtain the energy U is subject to Boltzmann's energy distribution law $N = N_0 \exp(-U/k\theta)$. The mean velocity of displacement of particles, ie the flow velocity of the ground, may be derived from this equation by means of equations

$$\dot{\gamma} = \frac{d\gamma}{dt} = \frac{\tau}{\eta(\tau, t)}; \quad \eta(\tau, t) = B \exp[U(\tau, t)/k\theta] \quad (7)$$

where, $\eta(\tau, t)$ is the variable viscosity

Formula (7) accounts for the variation of the activation energy, and hence also of the viscosity, as a function of the stress τ and time t , which is related to the changes in the microstructure of the permafrost during the deformation process. Special microstructure studies have been carried out to develop such changes. The principles governing the changes, obtained as a result of these studies, are described in the author's paper in the proceedings of this conference. Suffice it to mention

here that the deformation process is a consequence of two mutually opposing processes, ie the weakening of the ground structure as a result of the disturbance of interparticulate bonds and development of defects in the structure, and the strengthening cause by the appearance of new bonds and the "recovery" of defects. The strengthening leads to an attenuation of creep strain, while the weakening causes a development of non-attenuating progressing creep which ends with the failure of the ground. These processes are described by a single equation which defines also the process of deformation of the frozen ground as a function of time

$$\dot{\gamma} = \frac{d\gamma}{dt} = \left(\frac{\tau}{\tau^*}\right)^{1/m} \left(\frac{t+t^*}{t^*}\right)^{-n(\tau)}, \quad (8)$$

where, τ^* is a parameter which is a function of the physical properties of the frozen ground and its temperature, and $t^* = 1$.

This equation is true only for an isothermal process. Should it be necessary to take into account the external heat flux $N\dot{\theta}(t)$ and the ground temperature change with time $\theta(t)$, the thermodynamic equation (1) must be included. Then, expressing the thermodynamic forces in the form of a linear combination of fluxes we obtain, according to the investigations of the Leningrad university (A.I. Chudovskii), the following deformation equation

$$\dot{\gamma}(t) = \left[\frac{\tau(t)}{\tau^*(\theta)}\right]^{1/m} + \alpha[\theta(t) - \theta_0] + \int_0^t \left[\frac{\tau(\nu)}{\tau^*(\theta)}\right]^{1/m} [-N\dot{\theta}(\nu)] [K(\theta, t=\nu)] d\nu. \quad (9)$$

Based on thermodynamic concepts it is possible to derive also the equation for the creep limit of the frozen ground taking into account the inflow of thermal fluxes and the resulting temperature changes with time. For this purpose it is necessary to solve the equation (9) with respect to stresses, by introducing the condition for long term failure. This condition may be expressed as the increase in the entropy increment ΔS , during the deformation process, to a certain critical value ΔS_r which is achieved at the time of failure t_r

$$\Delta S_r = \int_0^{t_r} \dot{S}(t) dt, \quad (10)$$

where, $\dot{S}(t)$ is the rate of increase in the entropy density which can be expressed as the summation $\dot{S} = \dot{S}_e + \dot{S}_i$, where $\dot{S}_e = \frac{dQ}{dt} \frac{1}{\theta}$ is the external flux of entropy due to heat and mass exchange with the surrounding medium, and $\dot{S}_i = \dot{S}_i(\tau, \dot{\gamma}^p, \theta, F)$ is the internal source of entropy due to the dissipation work A^p and free energy F . Assuming that the dissipation work is expended on changing the ground structure and increasing the defect density, and making use of equation (8) it is possible to obtain the equation for long term failure, as was shown earlier by the

author (see the 1975 proceedings), in the form

$$\frac{1}{B} \int_0^{t_r} \exp \left[- \frac{\beta \theta(t)}{\tau(t)} \right] dt = 1. \quad (11)$$

This equation relates the time preceding the failure, t_r , the stress as a function of time, $\tau(t)$, and the temperature as a function of time, $\theta(t)$.

Taking advantage of thermodynamic concepts, we can obtain the equation which describes the thermal and mechanical interaction between the frozen ground and the building erected on it. Actual problems may be solved by means of computers, while the simplest cases may be solved by analytical means. A number of such problems are discussed in the authors paper presented at this conference.

Basic positions taken in SNIIP P-18-76

The following are the basic positions taken in the new SNIIP II-18-76 chapter titled "Bases and Foundations in Permafrost" which distinguish the new issue of the chapter from the preceding:

- improvement of foundation design methods and a significant increase in the design values of the strength characteristics of frozen soils;
- stipulation of the types of foundations for large loads, and of methods for their design;
- controlling thermal regimes and mechanical properties of permafrost beds (by means of preliminary refrigeration or thawing);
- elaboration of measures and methods of thermal engineering design, including methods using ventilation ducts, to ensure the maintenance of the design temperature regime of frozen ground;
- elaboration of recommendations to allow construction on unfavourable permafrost, such as salty, peaty, and ice rich permafrost, including ground ice;
- elaboration of recommendations for constructing in permafrost located in active seismic regions.

Improvement of foundation analyses

The new SNIIP and the old issue of the Construction Standards and Regulations accept two principles for the utilization of

permafrost beds: principle I - preservation of the frozen state of the ground, and principle II - allowing it to thaw.

Bed calculations are carried out for two limiting states, ie strength (load bearing capacity) and deformation. The strength calculation begins with the condition

$$N = \Phi / K_H, \quad (12)$$

where, N is the design load, Φ is the load bearing capacity of the soil, and K_H is the reliability coefficient.

The strain calculation begins with the condition

$$S \leq S_{np} \quad (13)$$

where, S is the settlement to be determined by the calculation and S_{np} is the limiting permissible value of the strain of the building which depends on its construction features.

As a rule calculations for permafrost which are used according to principle I are made on the basis of the load bearing capacity, because such ground has low compressibility. Exceptions to this are plastic frozen and ice rich ground where strongly noticeable subsidences may occur. In such cases calculations are carried out for load bearing capacity and for strain. It is known that the thawing of frozen ground causes significant subsidence. For this reason when permafrost is used according to principle II, calculations are carried out primarily for strain.

Frozen ground exhibits distinct rheological properties, ie the capacity for creep strain and loss of resistance to prolonged loading. Such properties must absolutely be taken into account in considerations to use permafrost as beds and in calculations carried out for this purpose. Calculations for load bearing capacity must be based on the creep limit R_{∞} , ie the load which, if exceeded, gives rise to non-attenuating creep causing failure or cave-ins (Fig. 1).

Correspondingly, the load bearing capacity of the soil in equation (12) is determined by

$$\Phi = mR; \quad R = R^H / K_r \quad (14)$$

where, R is the design resistance, R^H is the standard resistance, $M > 1$ is the coefficient for the work conditions, and $K_r > 1$ is the safety coefficient. In its turn $R^H = 1/n \sum_{i=1}^n R_{\infty, i}$, where, $R_{\infty, i}$ is

the ultimate creep limit obtained from the given equation, and n is the number of determinations.

Permafrost calculations for strain, which take into consideration the time factor, are based on the condition that settlement deformation during the service life-time of the building should not exceed the value stipulated by equation (13). The value of S in this equation is given by $S = S_0 + S(t)$, where, S_0 is the initial deformation and $S(t)$ is the settlement which develops during the time t ; $S(t)$ is determined by creep for frozen ground and by consolidation and creep for thawing ground.

Foundation analysis using principle I

According to SNiP conservation of the frozen state of bases is achieved by provision of ventilated basements, refrigerating ducts and pipes, and also by confining the thawing zone and laying the foundation below this zone (see Fig. 2).

Ventilated basements may be used not only to conserve the natural temperature regime of the ground under the building, but also to shift it in the desired direction. It may be made more rugged, for instance, and this is already being applied in practice. For this, according to G.V. Porkhaev, the following condition must be fulfilled:

$$M = \frac{F_B}{F_c} \quad (15)$$

where, F_c is the horizontal surface area of the building, F_B is the surface area of the ventilated area, and M is the ventilation modulus which is calculated as a function of air temperature in the building, yearly average temperature of outside air, yearly average temperature of basement air, heating pipes present in the basement, and the thermal resistance of the first storey floor. The method for determining the value of M is given in SNiP.

Pile (including hollow piles and pile posts of large diameter) and pillar foundations are the main types of foundation used in construction employing principle I.

The load bearing capacity of the ground, used in conjunction with conservation of the frozen state, is determined by means of formula (14) expressed in the following form (which was proposed by S.S. Vyalov as early as in 1959, and is given in SNiP, see Fig. 3):

$$\varphi = m \left(R_F + \sum_{i=1}^n R_{cm.i} F_{cm.i} \right). \quad (16)$$

This formula is applicable to all types of pile foundations as well as to pillar foundations. R is the design pressure exerted on the ground by the lower end of the pile or by the foot of the foundation; R_{CM} is the design shear resistance of the frozen ground along the lateral surface of the pile or the lateral edge of the foundation footing, F is the cross-sectional area of the pile or of the foundation footing, while F_{CM} is the surface area of the frozen boundary between the ground and the side of the foundation. The summation symbol is used because the type of ground and its temperature may vary along the pile and, thus, the R_{CMi} value may be different for each i -th layer.

As a rule the values of R and R_{CM} are determined experimentally under field or laboratory conditions. However, the Standard gives values of these parameters which may be used in absence of experimental data. Such values are given in SNiP for various types of ground and for various values of their design temperature θ^*). It is known that the ground temperature with depth varies during the year. Since the Standard usually assumes the worst conditions, the highest monthly average temperature of the year and a given depth, $\theta_{max}(z)$, is used for design purposes in order that the summation of the R_{CM} value curve over the entire length of the pile be a minimum (see Fig.3).

Such θ_{max} values are determined by means of thermal engineering calculations based on the yearly average temperature of the ground θ_0 . As a result of the accumulated practical experience and of data produced in special investigations, the values of R and R_{CM} given in SNiP P-18-76 are considerably higher than those recommended previously.

Equation (16) is simplified for homogeneous ground, and takes the form $\Phi = m (RF + R_{CM}F_{CM})$, where R and R_{CM} are determined for a certain equivalent temperature which is based on the minimum area of the curve R_{CM} along the pile and is determined by means of thermal engineering calculations.

In the case where determinations of the load bearing capacity were based on data obtained in field trials, we obtained the integral value of the limiting long-time load $P_{\infty} = P^H$, whence $\phi = \frac{K}{K_r} P^H$, where K_r is the safety coefficient. The coefficient K takes into account the circumstance that trials may be carried out at a ground temperature which differs from its design value. For this reason it is assumed that $K = \phi_{np} / \phi_{on}$, where ϕ_{np} is the load bearing capacity of the design pile calculated using equation (16) and tables of values of R and R_{CM} based on the design temperature θ_{max} ; while ϕ_{on} is the load bearing capacity of the experimental pile, also calculated by means of equation (16) but using temperature values, θ , recorded during the experiments.

*) In SNiP t is used for temperature and τ for time.

Piles are sunk into the permafrost using various methods, such as steaming, predrilling of holes and filling them with a soil grout, or driving piles into holes (when the hole diameter is smaller than that of the pile; this is done only in the case of plastic frozen ground), etc. Sinking of piles into holes (of large diameter) followed by pouring of soil grout into the well is the most widespread method.

In the case where the grout was prepared using the drilled out soil, shear resistance (R_{CM}) values are used which are appropriate to the type of soil which was drilled out for the pile. For ready mix sandy argillaceous or sandy calcareous grouts, the load bearing capacity of the piles may be increased using higher R_{CM} values. The increase is particularly effective in cases where piles are driven into weak ground ice; such as argillaceous, salty, peaty, and ice rich ground. In such cases the calculation of the load bearing capacity must be based on the condition of equivalence between the shear resistances of the soil grout along the surface of the pile, R_{CG} , and along the interface with the surrounding ground, R_{CM} , i.e. based on the condition $R_{CG}F_{CG} = R_{CM}F_{CM}$, where F_{CM} is the area of the adfreeze surface with the pile, and F_{CG} is the interface surface area between the grout and the surrounding ground, which equals the surface area of the hole (see Fig. 4).

Calculations for the settlement of pillar foundations erected according to principle I are made using equation (17), given below. The substantiation and experimental confirmation of this equation, based on observations over a period of 19 years, are reported in the author's paper presented at this Conference (Proceedings of the Third International Conference on Permafrost, Volume I, 1978).

$$s/d = 0,8(1-\mu^2)\beta \int_0^t \left\{ \frac{N(\nu)}{A[\theta(\nu)]} \right\}^{1/m} (t-\nu)^{\beta-1} d\nu, \quad (17)$$

where d is the diameter of the pile foundation, μ is Poisson's ratio for frozen ground, $A[\theta(\nu)] = a + b/\theta^n$ is the deformation coefficient which is a function of the temperature θ , which in its turn varies with time according to a certain law $\theta(t)$, $N(t)$ is the transient design load, ν is the integration variable, and t is the time.

Pile subsidence may be calculated using the following equation:

$$s/u = \left(\frac{1}{uL} \right)^{1/m} \beta \int_0^t \left\{ \frac{N(t)}{\bar{A}[\theta(t)]} \right\}^{1/m} (t-\nu)^{\beta-1} d\nu, \quad (18)$$

where, $\bar{A}[\theta(t)] = \bar{a} + \bar{b}/\theta(t)^\lambda$ is the temperature dependent strain coefficient which usually is also time dependent, u is the pile surface area, L is the embedment depth of the pile in the permafrost; the remaining notation is the same as in equation (17).

Equations (17) and (18), which are particular cases of equation (9), are used to determine subsidences of pillar and pile foundations, loaded with time variable loads. They take into account the transient temperature of permafrost.

Foundation analyses using principle II

According to principle II the ground is allowed to thaw either during the construction and use of the building, or in advance prior to its erection. The first case is used for permafrost of low subsidence and providing condition (13) is fulfilled during the thawing. For ground of high thaw subsidence SNIIP recommends taking special measures to either diminish the thaw settlement, or to provide arrangements in the building structure to absorb strong deformations.

Settlement may be decreased by means of controlling the depth of thaw using thermal insulation, replacement of ice saturated ground with sand and gravel, etc. However, the most effective method is the preliminary thawing of the ground (achieved by means of hydro and electric heating). The thawing depth is selected such that the subsequent subsidence, after thawing, of the underlying permafrost is located within the limits which satisfy condition (13).

The diminishing of settlement based on condition (13) is the basic principle of foundation construction on permafrost. Construction experience shows that thaw settlement, particularly of fine grained ice saturated soil, causes intolerable straining of buildings even in the case of the strongest reinforced structures. For this reason, and above all, it is necessary to diminish the magnitude of the ground settlement by any possible means, ie to create a foundation with predetermined properties. As additional measures SNIIP allows the provision of arrangements which enable buildings to absorb large settlements. These measures consist of either increasing the strength and the overall spacial rigidity of the building, or, on the contrary, increasing its yielding capacity and flexibility. In the first case we strive to enable the building to safely absorb strain which is caused by the additional stress, by providing its structure with reinforcing elements. In the second case we attempt to prevent the appearance of additional stress and to equalize any strain appearing in the structural elements. To this end foundation types which use the regular or crossed strips, or solid or box-like slabs, etc. are used for rigid structures, and individual pillar foundations for flexible structures.

Calculations for beds using principle II begin with the determination of the outline of the permafrost thaw zone under the building and its propagation with time. There are a number of methods and equations for such calculations. The most effective is the numerical method using hydraulic analogs, or computers. For everyday applications, however, it is still

necessary to use analytical methods in addition to instrument calculations. One such method, developed by G.V. Porkhaev, is given in SNIIP II-18-76. It may be used to determine the thaw depth, for a given time t , below the central point of the building H_c and under the periphery H_k (see Fig. 5). The calculation is reduced to the equations

$$\begin{aligned} H_c &= K_1 (\xi_c - K_c) B \\ H_k &= K_1 \xi_k B \quad \text{или} \quad H_k = (\xi_k - K_k - 0,1 \beta \sqrt{T}), \end{aligned} \quad (19)$$

where, $K_1, \xi_c, K_c, \xi_k, K_k$ are determined from nomograms and tables, given in SNIIP, as a function of design air temperature within the building and yearly average temperature of the permafrost, thermal resistance of the first storey floor, thermal conductivity of the frozen and thawed ground, total moisture content of the ground, and building width B and length L .

Maximum thaw depths under the central point H_{cp} and periphery H_{kn} of the building, achieved in steady state heating, is calculated using equations

$$H_{cp} = K_{11} \xi_{cn} B ; \quad H_{kn} = K_{11} \xi_{kn} B, \quad (20)$$

where, coefficients $K_{11}, \xi_{cn}, \xi_{kn}$ are determined from nomograms and tables.

Values of expected subsidence are determined in the next calculation step.

It should be noted that approximation formulae are available for estimating the thaw subsidence of the frozen ground. They are based on the fact that the compressibility $\delta = \Delta h/h$ of sandy ground is determined by the relative difference between the specific weight of the shell structure of thawed and densified ground $\gamma_{ck.T}$ and the specific weight of the mineral component of the frozen ground in its natural state $\gamma_{ck.M}$

$$\delta = \frac{\gamma_{ck.T} - \gamma_{ck.M}}{\gamma_{ck.T}}, \quad (21)$$

The compressibility of argillaceous ground is determined by its porosity, due to the melting off and easing out of ice, lenses, and partly also of the ice cement, as a result of densification under its own weight and load p , as shown in the following equation:

$$\delta = 1 - \gamma_{ck.M} \left[\frac{1}{\gamma_s} - \frac{1}{\gamma_w} (W_p + K_g \gamma_p) \right], \quad (22)$$

where, γ_s and γ_w are the specific weights of particles and water, W_p is the moisture content immediately prior to the compression, I_p is the plasticity number, K_g is a coefficient which is a function of the load pressure on the ground p .

These formulae may be used only for estimating the permafrost conditions of the site ground, selection of the construction principle, and similar purposes. Settlement determinations required for foundation design, must be carried out using more accurate equations which take into consideration the nature of stress distribution with the ground depth (see Fig. 6).

Even though the relationship between stress and strain is, strictly speaking, non-linear not only for frozen but also for thawing ground, for purposes of simplicity it is permissible to determine the settlement of such ground on the basis of linear deformation. Previously this was based on the system of elastic half-space. This is permissible also now for the case of thawing to great depths. Yet in this case the main system is assumed to consist of a weak (thawed) ground layer which is underlain by a rigid (frozen) permafrost and the stress concentration at the interface and the corresponding redistribution of stresses are taken into consideration. The equation for the determination of the settlement of strip foundations is obtained by subdividing the thawed ground zone into i layers and summing up the subsidence of each i -th layer of thickness h_i , as follows:

$$s = \beta p_0 M_{om} \sum_{i=1}^n a_i (K_i - K_{i-1}) (1 - \lambda_{ci}) + \sum_{i=1}^n [(A_i + a_i p_{\delta i}) (1 - \lambda_{ci}) + K_{\lambda i} \lambda_{ci}] h_i, \quad (23)$$

where, p_0 and $p_{\delta i}$ are the pressure on the ground under the foundation footing and the pressure due to its own weight at the i -th layer respectively, K_i and K_{i-1} are coefficients which account for the character of the distribution of the vertical stress due to load variation with depth; M_{om} is a coefficient which takes into account the underlain rigid layer and which is a function of the ratio H/b , H being the depth of occurrence of the boundary of the rigid (frozen) permafrost; a_i and A_i are the compressibility and thaw coefficients of the ground respectively, λ_c is the ice content of the ground prior to its thawing, b is the foundation width.

Thus, the first term of the right hand side of equation (23) accounts for the densification settlement of the thawed ground which is due to the action of the external load, the second term accounts for the densification settlement due to the ground's own weight and for the thaw settlement, while the third term accounts for the subsidence due to the melting of ice lenses and closing of macropores, and since the closing of macropores is incomplete, the coefficient $K_{\lambda i} < 1$ is introduced.

Parameters a and A are obtained from field or laboratory trial data. The latter are carried out in a soil compression

tester, ie under compression conditions which do not allow lateral expansion. Experimental data are plotted on a "compressibility δ versus load p " plot, which is then used to determine a and A . Experiments are carried out using samples which do not contain large ice lenses; the latter are determined separately (using cores obtained in drilling wells, or by measurements carried out on the walls of test pits) and are accounted for, as mentioned before, by the introduction of the special term into equation (23).

Field trials using heated pressuremeters give more reliable results than laboratory trials. Stepped loading is applied to these pressuremeters, after a thin layer of soil has been melted. Also in this case the values of a and A are determined from $\delta - p$ plots. The difference between laboratory and field trials is that the latter give the settlement of the total mass of the ground including the ice layers. For this reason in settlement determinations using field trial data, λ_{ci} in equation (23) must be assumed to equal zero.

When preliminary thawing is used, settlement occurs (prior to the erection of the building) as a result of the ground's own weight and is determined from equation (23) where $p_0 = 0$. On the other hand the settlement after the erection of the building equals

$$S = S_n + S_{gon}, \quad (24)$$

where, S_n is the settlement of the ground layer thawed in advance to a depth h_{om} and which is dependent on the subsequent (after the erection of the building) densification of the ground as a result of the external load; this settlement is determined using equation (23) where $A_i = 0$, $\lambda_{ci} = 0$, and $p_{\delta i} = 0$; S_{gon} is the additional settlement of the ground layer which has thawed, during the construction and use of the building, to a depth $H - h_{om}$ (where, H is the total thaw depth); this settlement is determined from equation (23).

Settlement propagation with time

Equations (23) and (24) give the final stabilized settlement. Yet, the nature of the progression of the settlement with time is of great importance, particularly when preliminary thawing is used. In this case it is important to know whether the settlement will terminate prior to the erection of the building, under the weight of the preliminarily thawed ground, or whether it will continue to propagate during the construction and use of the building. In this latter case the settlement must be taken into consideration in the strain calculations of the building.

The settlement progression with time occurs as a result of

the consolidation S and creep S_{cr} . It is permissible to assume arbitrarily that creep appears only after the completion of the consolidation process. In this case full settlement equals (Tsytovich, 1973):

$$S(t) = S_1 + S_2 + S_3 + S_4, \quad (25)$$

where, $S_1 = Ah(t)$ is the thaw settlement which is a function of the thawing of ice lenses and ice cement, and progresses with the increasing thaw depth; the latter equals $h(t) = \beta\sqrt{t}$; $S_2 = a[x_1 h(t)p + x_2 \gamma h^2(t)/2]$ is the densification settlement which progresses concurrently with the thawing under the action of the external load p_0 and the weight of the ground, $q = \gamma h(t)$, which depends on the permeability coefficient; coefficients x_1 and x_2 are functions of p_0 and q ; $S_3 = S_{30}^p u^p + S_{30}^q u^q$ is the additional densification of the ground, which occurs concurrently with the thawing under the action of the external load p_0 and the weight of the ground $q = \gamma H$ ($H = h_\infty$ is the thaw depth); $S_{30}^p = a(1-x_1)Hp_0$ and $S_{30}^q = 0.5a(1-x_2)\gamma H^2$ are the stabilized settlements, and u^p and u^q are the degrees of consolidation of the ground, determined by the solutions of the consolidation problem and dependent on the relationship $\lambda = \beta/2\sqrt{c}$, where, $c = k_\phi/\gamma_b a$ is the consolidation coefficient, and k_ϕ is the permeability coefficient.

S_4 is the creep settlement determined by the solution of the creep theory. In many cases this term may be ignored.

Settlement S_2 , which progresses concurrently with the thawing, and the thaw depth $h(t)$ are both proportional to the square root of time; thus, $S(t)/h(t) = \text{const}$. The nature of the consolidation process depends on the parameter λ , ie this process is determined by the rate of thawing, which depends on the thermal coefficient β and the permeability, the latter being dependent on the permeability coefficient k_ϕ .

If the rate of thawing is high, while the coefficient k_ϕ is low, then the consolidation continues after the thawing. If the thawing proceeds slowly and k_ϕ is large, then the consolidation process occurs during the thawing and $S_3 \approx 0$. This case is characteristic of thawing of ground during the construction and use of the building, where the thawing continues for a number of years, and the relationship for the settlement progression with time is determined by the thaw relationship $h(t) = \beta\sqrt{t}$. The situation is completely different in the case of thawing prior to construction. This thawing proceeds relatively quickly and if the ground is argillaceous and its permeability coefficient has a relatively low value, then the consolidation will continue also after the erection of the building. Moreover, the consolidation of the thawed ground, due to external load will occur and, thus, the value of the additional settlement S_3 will be high enough to be noticeable.

The combined interaction of building and ground

In deformation calculations for foundations it is necessary to examine the combined interaction between building and ground, taking into consideration that settlements depend on building structure and that after their appearance they react on the structure straining it and causing (in the case of statically indeterminate structures) a redistribution of forces.

SNiP stipulates safe strain limits for mass produced buildings using the most widespread construction configurations. In this case settlement determinations (average settlement, its variations, deviation angles) are included into the calculations and contrasted, in accordance with condition (13), with the limiting permissible deformation for the given type of building. The examination of the combined interaction between building and ground is limited to the determination of the reactive pressure of the ground onto the foundation footing and the calculation of the forces arising in the foundation as a result of this pressure.

The combined interaction between buildings and the ground must be considered primarily when designing buildings for which the limiting settlement is not given and has to be established by means of such calculations. As shown in the paper of V.G. Pozovskaya, L.I. Neimark, and this author, presented at this conference, the method used in this case is as follows:

Considering a building of a final rigidity the deformation of the thawed (preliminarily or during the construction and use) ground, due to the load of the building and the weight of the ground, is determined using the method explained above. The contact interaction problem between the ground and building is then solved, and the solution is used to determine the reaction of the ground acting on the foundation. In order to simplify calculations the building is arbitrarily replaced by a beam, or a system of interconnected beams, which is equivalent to the building with respect to rigidity and static action.

Knowing the ground reaction, the additional forces arising in the building structure (including the foundation), due to non-uniform settlement, deviation angles, etc., are determined. This non-uniformity is due to the curvilinear contour of the thawing zone of the ground under the building and to the non-homogeneity of the ground in the area. The additional forces are taken into consideration in the design of the structure.

The solution of the contact problem is carried out considering the foundation to be a beam or slab resting on an elastic level base. In this case the reaction q is distributed along the beam length x in accordance with the following law:

$$\bar{q}(x) = \bar{c}(x) [W(x) - Z_0(x)], \quad (26)$$

where, $\bar{c}(x)$ is the coefficient of local elastic deformations of the ground (base coefficient), $W(x)$ is the vertical displacement of the beam, z_0 is the settlement, due to the thaw settlement $s = Ah(t)$.

The coefficient $\bar{c}(x)$ is determined as a function of the densification settlement, and since this settlement progresses with time (as the thaw depth and the consolidation progress with time), this coefficient is also a function of time. Furthermore, the coefficient $\bar{c}(x)$ varies along the foundation length x , because the contour of the thaw zone is curvilinear; this means that also the settlement varies along the length x .

An analytical solution is available (see Fig. 7) for the simplest cases of the problem under consideration. It is explained in the "Manual for designing bases and foundations of buildings and structures erected on permafrost" (Stroiizdat, 1969). The method is based on the substitution of the curvilinear diagram of the reactive pressures $\bar{q}(x)$ with a system of concentrated forces. This reduces the calculation scheme to that of an elastic beam which is acted upon by the load from above and by the concentrated reactive forces from below; the latter represent the action of the base. Such a system is solved using the methods of structural mechanics. It should be noted that an increase in the rigidity of the base at any given point x , under the periphery of the building, for instance, where the thaw depth is low and, therefore, $\bar{c}(x)$ is high, causes an increase in the base reaction $\bar{q}(x)$. When this reaction reaches its limiting value \bar{p}_{np} , plastic flow of the ground occurs, which brings about a redistribution of the reactions and makes them more uniform. This has a beneficial effect on the function of the foundation. One of the beneficial factors is the decrease in the value of the settlement $z_0 = Ah(t)$; this is achieved best by means of pre-construction thawing.

Computer solutions of the problem are more effective; they permit taking into consideration a greater number of the factors influencing the combined interaction of buildings and bases.

Stanchion piles

In presence of rocky ground at accessible depths it is recommended to use stanchion piles for foundations. Their lower ends are embedded in rock. In the case of important buildings this method is used even when the rock occurs quite deep (up to 40 m). The pile types used are: sectional solid piles, post piles, casing piles, and even piles using concrete filled drill wells; in the latter case special precautions are taken to ensure good setting and hardening of concrete in permafrost. In all these cases construction is carried out using principle II (and measures to prevent floor settlement). It is taken into account that the thawing and settling ground will react on the pile with a negative friction which is considered as an additional load. The load bearing capacity of the pile is

calculated from the formula

$$\varphi = mRF - m_1 R_{cg.H} F_{cg.H} \quad (27)$$

where, R is the design resistance of the ground(rock) under the lower end of the pile; $R_{cg.H}$ is the negative friction; F and $F_{cg.H}$ is the cross sectional area of the pile and the area of its lateral surface within the limits of the thaw zone, respectively; m and m_1 are coefficients of working conditions.

Calculations of pile material strength must also be carried out for stanchion piles, taking into account pile buckling; the extent of the latter depends on pile length and on the quality of the pile fastening at both ends.

Pre-construction refrigeration of the ground

Preliminary thawing, one of the methods of controlling the characteristics of permafrost bases, was examined above. Another method, which is the opposite of the one described, uses refrigeration of the ground, which is particularly expedient in regions of unstable permafrost. In such regions the permafrost temperature is close to 0°C. Lowering the temperature increases significantly the load bearing capacity of the ground (decreasing the temperature from -0.3 to -1°C, for instance, increases the ground strength by a factor of 2.5), while increasing also the reliability of the foundation in case of an unexpected warming of the ground. Based on these considerations SNiP permits construction using principle I on plastic frozen ground provided that the building is refrigerated and ground temperature is lowered. Refrigeration is used also in the case of discontinuous permafrost in order to freeze the unfrozen ground and create continuous permafrost.

Most effective is the mechanical refrigeration using brine, which is used to freeze the ground around shafts of various mining excavations and foundation pits driven through quick ground. This method is, however, the most expensive. For this reason it is used only in extreme cases.

More effective is the refrigeration method using naturally occurring outdoor cold air of winter, ie exploiting the very severity of the northern climate. Such refrigeration is feasible only where the difference between the average yearly temperatures of the outdoor air and permafrost is noticeably high, ranging from 2 to 8°C and higher (which is due to the insulating effect of plant and snow cover, etc.).

Experience shows that, as a rule, a high ventilated basement has the effect of decreasing the temperature of the permafrost under the building with passage of time. As mentioned, such decrease in temperature occurs not immediately,

but over a certain period of time, yet the design is based on ground characteristics present at the completion of construction. For this reason ground refrigeration must be accomplished by this time. It is expedient, therefore, to carry out refrigeration prior to construction start and to maintain the lower temperature by means of a ventilated basement. Such refrigeration is achieved by means of systematic snow removal, refrigeration of foundation pits, blowing cold winter air into boreholes prior to the installation of piles in them, etc. A widespread practice uses periodic refrigeration of the ground by means of cold air which is pumped into the ground in winter time or left to circulate by natural convection. The most efficient are refrigeration installations (thermal piles) using liquid (kerosene) or highly volatile liquid (ammonia, propane, freon) refrigerating agents which are self-regulating and seasonally acting. Such installations do not consume energy, do not require attendance, and are of relatively simple construction. Thermal piles are employed in the USA and Canada, and also in the USSR for lowering the temperature of plastic frozen ground in order to improve its load bearing capacity and reliability, for freezing unfrozen ground in area of discontinuous permafrost, for the creation of frozen cores in dams, for the reestablishment of the frozen state under foundations where permafrost has thawed unexpectedly, etc. They are used as independently acting installations, or mounted within the body of reinforced concrete or steel cased piles (ie proper thermal piles).

The lower temperature achieved around the installation in winter increases somewhat in summer, due to heating by the surrounding ground; yet a general decrease in the temperature of the ground is achieved nevertheless. In conjunction with ventilated foundations the method has an extremely noticeable effect, to the extent that even ground temperatures are lowered significantly during the first year.

Applications of thermal piles is particularly effective in the case of buildings with seasonally varying loads, due to air temperature variations, wind, snow, ice crust, and seasonal and general ground adaptation. Such loads apply predominantly to supports for power transmission lines, gas pipelines, trestle bridges, etc. The appearance of such loads, or the occurrence of their extreme values coincides with the coldest period of the year, ie with the period where the ground load bearing capacity is at its maximum, due to refrigeration by means of thermal piles. This renders the employment of thermal piles exceptionally effective for above structures.

Thermal pile calculations must be carried out in two stages:
1 - determination of the temperature of the ground field around the pile and its periodic variation with time; 2 - determination of the creep limit and progressing settlement, taking into consideration the variable loads and transient ground temperature.

The first part of the above problem, which is in the domain of thermal physics, is solved by making certain assumptions and using mathematical models in conjunction with computers or

analytical methods. The active winter and summer periods and the passive periods, when there is no change in ground temperature, are all considered separately.

The second part, the calculation of the settlement creep limit of the permafrost with consideration of the variable load and changing temperature regime of the ground, is solved by means of equations (9) and (11).

The law governing the temperature variation of the ground around the thermal pile may be assumed to be cyclic $\theta(t) = \theta_0 - (\theta_0 - \theta_{max}) \cos \frac{2\pi t}{t_1}$, where, θ_{max} and θ_0 are the maximum and average temperatures of the ground respectively, $t_1 = 1$ year. The dependence of the strength and deformation characteristics, Γ , of the ground on temperature are expressed by means of the empirical equation $\Gamma(\theta) = a + b/\theta^n$. Then, the equation of the creep limit (11) assumes the following form:

$$1 \leq \frac{1}{B} \int_0^{t_z} \exp \left\{ - \frac{a + b[\theta_0 - (\theta_0 - \theta_{max}) \cos \frac{2\pi t}{t_1}]^n}{\tau(t)} \right\} dt, \quad (28)$$

where, $\tau(t)$ is the design load $N(t)$ referred to the unit area F of the lateral surface of the pile or the footing of the post foundation $\tau(t) = \frac{K_T K_H}{m_p} N(t)$, (where, K_T , K_H , and m are the coefficients of safety, reliability, and working conditions respectively, as stipulated by SNiP), t_r is the service lifetime of the structure.

Equation (28), solved by trial and error, is used to calculate the load bearing capacity of the ground, which is refrigerated by the thermal pile, taking into consideration the cyclic variation of temperature and transient load.

The law governing the development of the settlement S with time, taking into consideration the temperature variable and time dependent load, is given by equation (9). After a number of assumptions it takes the following form:

$$s/B = \frac{w \tau_{max}}{a' + b'/\theta_{max}^n} + \left\{ \int_0^{t_z} \frac{w \beta (t-\gamma)^{\beta-1} \tau(\gamma)}{a' + b'[\theta_0 - (\theta_0 - \theta_{max}) \cos \frac{2\pi \gamma}{t_1}]^n} d\gamma \right\}^{1/m}, \quad (29)$$

where, b is the width of the foundation (cross-section of the pile); w is a coefficient which depends on the type of foundation (pile); the remaining nomenclature is the same as in equations (28) and (17).

Construction under special conditions of frozen ground

Some permafrost exhibits special conditions that are unfavourable for construction. These are plastic frozen ground with unstable temperature regimes, and peaty, saline, or ice rich permafrost ground. Conditions for construction on plastic frozen ground were examined above. We shall describe here the

peculiarities of peaty, salty, and ice rich permafrost ground used as foundation soils.

Saline, peaty, and especially ice rich permafrost ground, and most particularly permafrost containing ground ice, have a number of negative properties which are unfavourable to construction. Their utilization as foundations presents definite difficulties. For this reason areas with such ground have been avoided, where possible, until recently. As for ground ice no structures were erected on them. The widespread construction activity going on in the North today has made it necessary to forego such selective practices. Because of technological and other considerations any type of ground is used today regardless of the characteristics of its components. For this reason it was necessary to conduct a number of investigations on such ground and to work out special methods for their utilization as foundations. The resulting recommendations are given in the new chapter of SNIIP II-18-76.

The peculiarity of peaty and saline permafrost is that, due to the plant remnants contained in the former and ice content of the latter, their freezing temperatures are considerably lower than those of regular soils. For this reason they are in a plastic frozen state even at relatively low temperatures. According to SNIIP requirements foundation calculations for such grounds must be carried out for a bearing capacity, based on condition (12), and also for a settlement, based on condition (13). Either post foundations or pile foundations may be used. In order to increase the load bearing capacity of the piles in the latter case, holes must be backfilled with sandy-calcareous grout and not with the mud from the drilled out holes. In this case calculations may be based on the condition of equality between the shear resistances of this grout at the freezing surface with the pile and along the contact surface with the surrounding weak (saline or peaty) ground. Since the latter resistance is considerably lower than grout resistance at the surface of the pile, it is necessary to increase the hole diameter in order to respect the condition of equality and to permit the pile and the surrounding grout to act as a single post of large diameter (see Fig.4).

The design values of the indicated characteristics are stipulated in the Standard. It is recommended that the ultimate value of the limiting load be obtained by means of field trials. The same applies also to the determination of the potential settlement of foundations.

The well-known peculiarity of ice is its capacity for viscous deformation and flow under any load value above zero. For this reason there was lack of confidence regarding the possibility of using ice rich grounds, and particularly those containing ground ice, as foundation soils. It was considered that such soils would lead to the development of endless and large settlements. Yet, painstaking research on ice (Vyalov et al, 1976) has shown that it has two critical stress

values with two strongly differing strain characteristics. For stress values not exceeding a value R_{λ} ice deforms at such a slow rate that the permissible limit is not exceeded during a time period which is comparable to the useful lifetime of the building (50-100 years). For stress values higher than R_{λ} , but not exceeding σ_{λ} , ice flow occurs at a constant velocity and transition to the progressive stage, which has an accelerating velocity, does not occur (see Fig. 8). Hence, calculations for ice layers are carried out for strength and for strain. Strength calculations consist of ensuring that the pressure applied to ice does not exceed the value R , and in the case of the shear resistance along the lateral surface of the foundation - that the value $R_{CM\lambda}$ is not exceeded. These values are used in equation (16). Recommended values for them are given in the Standard.

Either post foundations or pile foundations may be built on ground ice. An obligatory condition is, however, that direct contact between foundation and ice be excluded. For this reason sand is used under the foundation footing; while in the case of piles the holes are backfilled with sandy calcareous grout, and pile calculations are based on the strength equality condition.

Settlement calculations for post foundations are based on condition (13). For this condition S is taken to equal: $S = S_y + S_n$, where, S_y is settlement dependent on the densification of ice (due to the squeezing out of air bubbles), while S_n is settlement due to plastic-viscous flow of ice, cumulative over the useful lifetime of the building T_r , and equals $S_n = vt_r$, where, v is the velocity of ice flow, which is a function of load and of the viscosity coefficient. The viscosity coefficient is a function of ice temperature. The pressure P_0 , transmitted to the ice, is checked. It must satisfy the condition $P_0 \leq K\sigma_2 / 3\sigma_{\lambda}$, where, K is a coefficient which depends on foundation dimensions.

The pile settlement is determined from data of field trials.

A number of buildings have been built on ground ice and on saline and peaty soils and are being used in a normal fashion.

Bases and foundations built on permafrost in seismically active regions

Regions of high seismic activity (above 7 on the Richter scale) are encountered in permafrost territory. The peculiarities of base and foundation design under these conditions is also considered in SNIIP II-18-76.

First of all let us note that the seismic scale value of an area depends on the condition of its permafrost. If the

area consists of frozen ground with temperatures up to -2°C and if this temperature can be maintained after the erection of the building, the frozen state of the soils has no influence on the scale value. If the ground temperature has a temperature below -2°C , the seismic value of the area will decrease by one unit; but if ground thaw is predicted, the seismic scale value will increase by one unit. Based on these and other considerations, SNiP recommends, as a rule, the use of principle I for construction on permafrost in seismic regions, ie with conservation of the frozen state. If, for technological or other reasons, it is not possible to use principle I, principle II may be applied but only on condition that foundations be supported on ground of low compressibility, ie on rocky or coarsely fractured ground, or in conjunction with preliminary thawing and densification. Foundation calculations must be carried out under consideration of the seismic effect. The load bearing capacity of the foundation is determined using equation (16) and with the inclusion of an additional coefficient of working conditions, $m_c \leq 1$. Furthermore, a verification of cross-sectional strength of piles is made under consideration of horizontal seismic effect.

Effect of horizontal loads

In addition to determinations of the distribution and effect of the vertical load N , pile foundation calculations must be carried out also for the reaction to horizontal loads including those arising from seismic action. These calculations must include the following:

- investigation of the bending strength of piles under the action of horizontal forces applied at the upper end of a pile embedded in the ground;
- investigation of the stability of the pile embedment as a function the ground resistance to a pressure applied to the side of the pile;
- investigation of the extent of horizontal displacement at the upper end of the pile under the condition

$$y = y_{np}, \quad (30)$$

where, y_{np} is the limiting permissible pile displacement which depends on the building structure and as established in the design.

When calculating the effect of the horizontal load on the pile, the latter is considered to be an elastic beam laying on a linearly strained base. It is assumed that the base is characterized, according to Winkler, by the base coefficients C , ie the coefficient of proportionality between load and the

strain appearing at the point of application of the force. The calculations must be based on the worst possible case, which occurs during the autumn when the upper layer of the ground is thawed and is very soft, while the lower end of the pile is restrained in the permafrost layer. These conditions are accounted for by the bedding coefficient C which is time dependent with the ground depth. As a first approximation it is assumed that C increases linearly with depth (Fig. 7, Scheme 1). Such an approximation is based on the fact that not C , the base coefficient, itself is used in the calculations, but a certain general deformation coefficient, which accounts for the deformation characteristic of the ground as well as the rigidity of the pile. This coefficient is determined in trials using fullscale piles and horizontal loads. It, therefore, reflects the actual nature of the variation of the base coefficient with ground depth. Concurrently, also the rheological properties of the ground must be taken into account. For calculations of fast acting loads (seismic, dynamic, etc.) values are determined in trials under similar fast acting conditions; while for static long acting loads they are determined in prolonged trials allowing the displacements to stabilize at every load stage.

For piles installed in solidly frozen ground (possessing higher strength) it is permissible to assume that they are completely restrained in the frozen ground. Moreover, if the depth of the thawed layer, H_T , is not great, say if $H_T \leq 5b$ (where b is the cross-sectional area of the pile), then the resistance of this layer may be ignored and the pile may be considered to be a free cantilever which is restrained in the permafrost to a depth of $1.5b$ from the surface of the permafrost (Fig. 7, Scheme 2). However, if $H_T > 5b$, the resistance of the thawed ground layer must be taken into account, and the pile is to be considered to be a beam on a linearly strained base which has a time dependent coefficient C (restrained in the permafrost to a depth of $1.5b$ from the permafrost table; Fig. 7, Scheme 3).

The bending moment M and the shearing force Q for these two schemes are determined from the following equations:

for scheme $M = \pm 0,5 \ell \eta_1 T ; Q = \eta_1 T$ (31)

for scheme $M = \pm a \eta_2 T ; Q = \eta_2 T$, (32)

where, T is the horizontal load; $\ell = \ell_0 + 1.5B$ is the length of pile section extending from the floor joists to the surface of the permafrost; η_1 is a coefficient which depends on the magnitude of the vertical load N , pile rigidity EI (where, E is the modulus of elasticity of the pile and I is the moment of inertia), and pile length L ; while η_2 and a are coefficients which depend on these same factors and also on the strain coefficient α .

The remainder of the calculations is carried out as regular calculations for the strength of reinforced concrete and metal structures.

Forecasting changes in the geocryological conditions of the area

The clearing of permafrost terrain and its development lead inevitably to changes in the geocryological conditions, and these changes are usually unfavourable. Cutting down forests, destruction of vegetation cover, thermal action of buildings, discharge of water, etc. bring about an increase in the permafrost temperature and in the depth of seasonal thaw, and sometimes a thawing of the permafrost. This, in turn, leads to the formation of swamps in the territory and to the development of thermokarst, soil erosion and so on. For this reason the Standard requires that measures be taken to ensure a minimum disturbance of the natural conditions of the terrain under development, ie conservation of the vegetation cover, arrangement of embankments, etc. Special attention is given to the construction of lines of communication and pipelines and to protecting the permafrost from their thermal action.

Yet, despite all such measures the development of the territory inevitably leads to changes in the cryological conditions. One of the main tasks of technological research and design is to forecast such changes in order that they may be taken into account in the design stage. The methodology of such forecasting is discussed in some of the papers presented at this Conference.

By way of conclusion we would like to show a few photos illustrating examples of buildings erected on permafrost.

Fig. 9 and 10 show residential developments constructed on permafrost according to principle I, ie conservation of the frozen state of the ground.

Figures 11 to 14 show residential and administrative buildings with open ventilation basements; Fig. 14 shows a building with an enclosed basement where ventilation is achieved by means of openings (vents) in the plinth.

Figures 15 and 16 illustrate the erection of a box-like strip foundation and of the ground level of a building constructed on a thawing base using principle II and partial preliminary thawing of the ground.

References

1. SNiP, 1976. Construction Standards and Regulations, Part II, Chapter 18. Bases and foundations on permafrost (SNiP II-18-76),

- Stroiizdat, Moscow, p. 48, 1976.
2. Proceedings of the 2nd International Conference on Permafrost, 8th edition, Yakutsk, Knizhnoe Izdatel'stvo, Yakutsk, p. 296, 1975.
 3. Proceedings of the 3rd International Conference, Edmonton, 1978.
 4. Vyalov, S.S. The rheological principles underlying the mechanics of grounds. Vysshaya Shkola, p. 448, 1978.
 5. Tsytovich, N.A. The mechanics of frozen ground. Vysshaya Shkola, Moscow, p. 446, 1973.
 6. Vyalov, S.S., V.V. Dokuchayev, D.R. Sheinkman. Ground ice and ice rich grounds used as bases for buildings. Stroiizdat, Leningrad, p. 168, 1976.

List of Illustrations

Fig. 1. Creep curves

- a - attenuating creep ($P < P_{\infty}$),
- b - non-attenuating creep ($P \geq P_{\infty}$)

Translator's note: For both above conditions (in brackets) the author probably meant to use the Latin "R" instead of its Cyrillic equivalent "P". See Equ. (14).

Fig. 2. Conservation of the frozen state of the base

- a - ventilated basement,
- b - confinement of the thaw zone by means of a foundation sunk lower than the zone,
- c - ventilated ducts in the fill

Fig. 3. The scheme for foundation calculations

- a - on posts,
- b - on piles

Fig. 4. Calculation of the pile load bearing capacity according to the equal strength condition

Fig. 5. The scheme for the calculation of ground thawing under the building

Fig. 6. Pressure distribution in the thawed ground

Fig. 7. Calculation scheme for foundations on thawing ground

- a - calculation scheme (1 - thawed ground, 2 - frozen

ground, 3 - foundation beam),
b - bending moment diagram,
c - shear force diagram

Fig. 8. Ice strain curves

1 - slow secular flow ($\sigma < R_A$),
2 - viscous flow at constant velocity ($\sigma < \sigma_A$)
3 - progressive flow at increasing velocity ($\sigma \geq \sigma_A$)

Fig. 9. Buildings built on permafrost using the conservation of the frozen state. A street in an arctic city.

Fig. 10. A residential development built on permafrost using the conservation of the frozen state.

Fig. 11. Not available

Fig. 12. An administrative building on an open ventilated basement.

Fig. 13. Telegraph operation office on an open ventilated basement.

Fig. 14. An administrative building on a ventilated basement and enclosed plinth with ventilation openings (vents).

Fig. 15. A residential house on an enclosed plinth with a ventilation slit (below).

Fig. 16. Houses on ventilated basements, plinth with vents.

Fig. 17. Erection of a box-like foundation under a residential house being built on thawing ground (with partial preliminary thawing).

Fig. 18. Erection of a residential house on a box-like foundation built on thawing ground.

DESIGN, CONSTRUCTION AND OPERATION OF EARTH DAMS IN ARCTIC
REGIONS AND UNDER PERMAFROST CONDITIONS

Tsytovich, N.A., Kronik, Ya.A., and Biyanov, G.F.¹

Abstract

The paper gives a general overview of published information gained in the design and construction of dams, using local construction materials, in the arctic regions and under permafrost conditions in the USSR and other countries. The intricacy and complexity of the problem, which requires a complex approach and rigorous consideration of local climatic, engineering geocryological, technological, and economic peculiarities, are shown. The basic features of engineering geological research and of the geocryologic investigations carried out to improve the design and construction of earth dams are examined in detail. Design and construction principles for earth dams using local materials and the basis for analyses of earth dams and their foundations are expounded. Essential features of such topics as the organization of construction activities, construction technology of frozen and unfrozen earth dams including the technology of winter laying of cohesive earth materials into

¹Tsytovich, Nikolai Aleksandrovich - Corresponding Member of the Academy of Sciences of the USSR, Distinguished Scientist and Technologist of the RSFSR, Chairman of the Department of Soil, Bases, and Foundation Mechanics, Director of the Scientific Research Branch Laboratory for Permafrost Engineering and Hydro Construction (ONILIMES), Doctor of Technological Sciences, Professor at the Moscow Construction Engineering Institute (MISI).

Kronik, Yakov Aleksandrovich - Director of the Branch ONILIMES Laboratory (located at MISI) of the USSR Ministry of Energy and Electrification and of the USSR Ministry of Higher and Secondary Special Education, Candidate of Technological Sciences, Senior Scientific Worker.

Biyanov, Gavriil Fedorovich - Director of the Laboratory for the Technology of Construction of Earth Dams of the Scientific-Research Station of the hydroelectric project of the USSR Ministry of Energy and Electrification.

the bodies of dams, stock-piling of earth materials in quarries, construction of discharge facilities and water discharge rates during construction, are described. It is emphasized that frozen and unfrozen earth dams are fully reliable water engineering structures, providing the entire project was well-founded, the design carried out in-depth, the quality of construction work maintained at a high level, and the operation of the project placed in well qualified hands.

Foreword

The design and construction of earth dams in permafrost and arctic regions is an extremely intricate problem which requires a complex approach. For this reason this general overview was written by a group of specialists consisting of the following: the author of the foreword - a Doctor of Technological Sciences employed in the fields of permafrost mechanics and engineering; Ya.A. Kronik - a Candidate of Technological Sciences and a specialist in permafrost engineering, research on cryogenic processes of soils, and study of the behaviour of earth dams constructed on permafrost; and G.F. Biyanov - a professional engineer and the most experienced constructor (chief engineer) of a number of earth dams in the arctic regions of the USSR.

Section 1 of the paper (The practice of dam...) and Section 5 (The organization of construction activities...) were written by G.F. Biyanov; Section 2 (Engineering-geological research) and Section 4 (The basis of calculations for earth dams) - by Ya.A. Kronik, and the foreword and Section 3 (Principles of design and construction) - by N.A. Tsytovich.

This paper was prepared exclusively on the basis of data taken from published literature (see the list of references given at end of paper).

1. The Practice of Dam Construction in the Arctic Regions of the USSR

The problems of water management construction in the arctic regions are no less acute than in any other region of our country. Dams are constructed here to create water management reservoirs for hydroelectric power stations, tailings storage reservoirs for mineral dressing plants, cooling water ponds for thermal and atomic power plants, water supply systems for communities and industrial enterprises, for flooding placer areas, and also for agricultural needs.

In the Soviet Union the opening up of an arctic regions, where rich deposits of non-ferrous and other mineral deposits are present, is accompanied by an intensive program of construction of water engineering systems. One of the first dams, built as early as the end of the 18th century, was the frozen earth dam on the Mykyrt River in the city of Petrovsk-Zabaikal'skiy.

It functioned successfully for about 140 years and collapsed during repair work [1-3]. A number of dams was built at the very beginning of this century and also in the 1930's and 1940's. It is interesting that during this period dams were constructed without sufficient consideration being given to the specific geocryologic conditions of the region. For this reason such installations often failed, and their exploitation was marked by high material losses.

Towards the end of the 1950's and during the 1960's the centre of gravity of the intensive dam building program in the North shifted to Eastern Siberia [1,3]. A number of low and medium pressure-head dams of the frozen and unfrozen earth types was constructed. Among these are the unique dam of the Vilyuysk hydroelectric station and the Khantaysk dam.

The use of a more reliable selection of structures and construction methods is characteristic of this northern dam building period. The technology of winter construction was developed in a series of scientific research investigations and large scale construction experiments. Using this technology earth dams may be constructed practically under any natural climatic conditions, around the year, and without seasonal interruptions [1, 3, 23, 27, 29, 30].

2. Engineering-geological and geocryologic research for the design and construction of earthfill dams

In order to ensure the efficient design and construction of earth dams for a reliable long-term operation under arctic and permafrost conditions, a program of comprehensive detailed research work must be conducted. Such a program must include research to substantiate the selection of the dam centreline and location of the water reservoir, search for local deposits of construction materials, development of methods of forecasting the influence of water supporting structures on the surrounding medium, and particularly the influence of the dam and water reservoir on the permafrost foundation and changes in the banks. The extent and composition of the research work is determined by the design, category and function to be carried out by the structure to be constructed; they also depend on the degree of familiarity with the engineering geological, hydrologic, and geocryologic conditions of the area selected for construction.

Collection and analysis of climatic and hydrologic data start at the very beginning of the stage where plans for the exploitation of the water resources of large rivers and individual areas are put together. In case the collected data are insufficient, temporary or permanent hydro-meteorological and hydrologic stations are organized in order to ensure collection of a sufficiently large volume of natural observation data required during the design stage.

During the initial stages the main attention must be given to the collection of data on engineering geological conditions

and geocryologic familiarization of the area, which form the basis of a rational selection of the dam centreline and the determination of the dam type, layout, and main characteristics. The main principles governing the selection of dam centreline and the methodology of engineering geologic research for water engineering construction in the arctic regions are distinguished by specific peculiarities, due to the presence of permafrost, and which must be considered in addition to the general features present also in regions of temperate climate and on unfrozen ground [4]. The most important of these main principles are the following:

1. Carrying out a complex permafrost-hydrogeological and engineering-geological surveying [5] for the substantiation of the design and development of the forecasting of changes in the engineering geological, hydrogeological and geocryologic conditions caused by the construction. Particular attention must be devoted to permafrost surveying in areas with complex permafrost (geocryologic) conditions and with permafrost islands, such for instance as illustrated in Fig. 1 which shows the geological section along the dam centreline of the right-bank dam of the Ust'-Khantaysk hydroelectric station [3].

2. A complex and comprehensive study of the structure, composition and properties of the permafrost foundation of structures. Particular attention must be given to the study of the cryogenic structure of permafrost and to changes in its physico-mechanical properties and permeability occurring during and after the thawing. Attention must also be given to changes in the rheological properties which account for the relaxation of permafrost stress and creep under load.

It is important to note that, as a result of a systematic approach and generalization of voluminous research materials on northern water engineering construction, Soviet scientists and designers have developed a methodology for complex studies of permafrost used as foundations for structures. They have established the principles governing the formation of cryogenic structures and demonstrated the primary and determining role of them in the engineering-geological evaluation and forecasting of changes in properties of permafrost foundations of water engineering structures [6].

High earth dams are usually built on the most reliable solid rock foundations. Such are the cases of Vilyuysk, Ust'-Khantaysk and Kolyma hydroelectric dams in the USSR, and Kenney and Outardes-4 in Canada, for instance [3, 7, 8, 9]. Medium and low pressure-head dams are built on reliable rock foundations less frequently. Such earth dams are built practically on any type of bed. In such cases, therefore, research must be concentrated primarily on the study of the settlement of permafrost foundations during thawing and on structural means of connecting to banks and foundations. For ice rich permafrost, frozen earth dams are employed. Concurrently, the ground is not permitted to thaw, and freezing of the dam body is carried out. One such

example is the Ierelyakh dam (see Fig. 3) [3]. In the case of ground with individual permafrost islands unfrozen earth dams with stratified profiles are often used on bases which are allowed to thaw during their operation. Examples for such a type are the right bank dam of the Ust'-Khantaysk hydroelectric power station (Figures 1 and 2) [3], retaining dykes of the Kelsey water reservoir [8, 9], and the right bank of the Kettle dam [1].

3. A study of the temperature regime, and cryogenic structure and processes within permafrost bases. This study is used as a basis for the development of analytical methods for the stability and reliability of permafrost bases and of earth dam and foundation combinations, and for forecasting changes in the engineering-geocryologic conditions which occur after the construction of the dam and water accumulation in the reservoir. In addition to the studies of the thermal regime and cryogenic structure of permafrost, carried out in the research program, it is necessary to enlist concurrently the services of specialized research organizations to conduct a careful study of the cryogenic processes and phenomena (cryogenic heaving and fissuring, solifluction and thermokarst of ice formations, etc). The results of these studies must then be taken into account in the design stage of dams and water reservoirs and in the forecasting of changes in conditions and of banks [3, 10, 11].

During the subsequent design stages particular attention must be given to the forecasting of the temperature-moisture regime of the foundation and dam-foundation combination, their stress-strain relationship, strength and stability during long-term operation under severe climatic conditions, and also to the forecasting of reservoir bank transformations in permafrost regions [3, 11] as well as the influence of the constructed system on the surrounding ground. To draw on the experience accumulated in the construction and operation of similar dams alone is not sufficient to solve such problems. It is even more important to use natural observation data collected at the given individual construction project. Collection of data must be organized at the very beginning of the investigations. It must then be continued uninterruptedly during the design and construction stages and also during the operation.

This applies particularly to natural observations of the temperature regime of frozen and thawed foundations and of the stability and strain in the banks of the canyon.

4. Carrying out more detailed and careful search of local occurrences of materials for the construction of earth dams. This applies particularly to the search and selection of optimal types of cohesive soil for impermeable structural elements and of non-cohesive soils for filters and drainages. It is necessary to determine the exact contour of the occurrences and to estimate the reserves during the initial stages of investigation, so as to avoid a situation where shortages of specified materials are experienced during construction. Such

a situation occurred during the construction of dams of the Ust'-Khantaysk hydroelectric power station which necessitated the use of artificial soil mixtures and crushed rock.

When searching for occurrences of earth materials, consideration must be given to the distance from the construction site, which should be minimal. Also the possibility of filling the dam body with practically any type of fill available locally including stripped rock and material from mining excavations should be weighed for the appropriate dam construction type and land improvement measures. It is preferable, however, to use earth materials of optimum composition and minimum moisture (ie closest possible to the optimum). Their occurrences (quarries) must be delineated accurately and researched in detail during the preparatory work for the dam construction and associated technology. Experience gained in construction of earth dams at the Vilyuysk, Ust'-Khantaysk, and Kolyma hydroelectric and Magaden thermal power stations shows that the optimum earth materials for impermeable structural elements coarse detrital soils with sandy-loam filler [12, 13] containing 40% to 65%, by weight, of coarse detrital particles (larger than 2 mm), and similar artificial soil mixtures consisting, for instance, of sandy loams, loams, or light clay with morainic and coarse detrital soils with sand-gravel mixtures, or with fragmented semi-rocks. As a rule such soils are confined to eluvial-deluvial and morainic [12, 13] Quaternary deposits, and less frequently to fluvioglacial and colluvial deposits, which are often the components of bodies of natural talusses and rock streams.

For support fills it is recommended to use any type of rock or semi-rock which satisfies the essential requirements for strength and non-susceptibility to frost. Where special zoning of the dam body is used, earth materials with lesser non-susceptibility to frost may be used for the zones which will not be subjected to considerable temperature fluctuations. The use of rock and semi-rock earth materials of lower strength must, however, be justified on the basis of special investigations.

5. Characteristics of the boring and mining exploratory work within a complex geophysical and other research program, and the careful preparation of all documentation. The specific characteristic of boring and mining work in permafrost regions is due to the necessity to work out the methodologies of drilling and tunnelling. They must be carried out in such a way as to ensure that the most reliable information on the true temperature regime and cryogenic state of permafrost is obtained, and that the drill cores or the monoliths are representative of the undisturbed composition of the permafrost. For this purpose it is necessary to follow the following rules in boring operations: use of the columnar method and low rotation speeds; no water is to be poured into the borehole; the hole should be cooled at the face; and, the largest possible bore diameter should be used. Good results were obtained in the preliminary investigations of the Kolyma hydroelectric station, for instance, where diameters

up to 1000 mm were used in the exploratory borings and core extractions were taken from the entire depth of the hole. The same applies also to the passage of adits and the large cross-section excavations. In this way it was ensured that the information obtained on the geological and geocryologic structure of the bedrock was most reliable. It is also necessary to take into account that in the zones which are likely to contain groundwater, or at the boundaries between permafrost and unfrozen ground, the underground excavations in permafrost fill up with ice quite quickly and it is often impossible to use them for further exploratory work. This was observed in the small cross-section adits under the dam centreline of the Kolyma hydroelectric station.

Another most important requirement is the necessity to correlate the immediate geological exploratory work and direct geotechnological methods of determination of the composition and properties of permafrost and their cryogenic structure, with the geophysical work and indirect methods. In this way it is possible to carry out a complex program of a large volume of comprehensive research within the shortest period and with a sufficiently high reliability of information.

Every boring and excavation operation must be documented very carefully. This must be done with the participation of the geological engineer (permafrost scientist), by sketching cryogenic textures, ice inclusions and all fissures, including cryogenic microfissures, and by distinguishing the fragments of large scale patterns of tectonic fissures. More often than not, the latter are distinguished by higher ice content and heaving [6]. It is imperative that the methodology and driving time-length of borings and excavations, and also the methodology and duration of temperature measurements including the duration the wells were kept exposed between the end of the drilling operation and the reestablishment of the natural temperature regime be recorded.

6. The necessity of carrying out experimental construction and special scientific research work. It is necessary to carry out special research and experimental construction work during the final stages of the investigations, at the beginning of construction, or more exactly, during the preparatory period prior to the erection of the main structures of the hydroelectric station, and also during the construction of underground passages of the station, ie water ducts, tunnels, concrete culverts and observation galleries, and during the preparation of the ground and filling of the dam bodies. The purpose of this research work is to refine the information on engineering geological properties and geocryologic structure of the permafrost base, on composition and properties of the earth materials for the dam, and to improve construction methods and technology for the dam and underground structures. During the preparation of the base and construction of under-ground structures, large sections of the base and quarries are opened up. This presents an opportunity to refine significantly and correct, to the minutest de-

tail, the information on the geological and cryogenic structure of the ground and, hence, to make the necessary corresponding refinements and corrections in the project program and construction technology. Unforeseen circumstances and certain peculiarities of the permafrost, which were not discovered during the investigations, may be exposed. For this reason it is necessary that geocryologists and research workers participate, together with design and construction engineers, in the operational solution of problems as they arise during the construction.

It is also important that the following questions be studied or developed in experimental construction work prior to the erection of the dam: development of quarries and foundations; thawing of permafrost and its improvement by technological means to obtain optimum ground conditions; preparation and storage of unfrozen earth materials required for winter work; experimental laying of impermeable structural elements of cohesive earth materials (in summer and winter), making use of the best earth materials, technology, and compacting mechanisms; and the development and application of careful geotechnical quality control of the work carried out in the ground and rocks and of the construction of the earth dam.

Due to such complex and careful studies and geocryologic research, combined with subsequent experimental construction and scientific research work prior to and during the construction of earth dams, it is possible to work out extremely effective designs and rational technological schemes, which ensure high construction quality and reliable operation of earth dams under the severe climatic conditions of the arctic regions and on permafrost bases.

3. Principles of the design and construction of earth dams for operation under the permafrost conditions of arctic regions.

The design and construction of earth dams, for permafrost and arctic regions, must be based on data obtained in engineering geological studies of the construction site and on results of special geocryologic research. The latter consists primarily of the following: permafrost thickness, its temperature at a depth of 10 m, and the cryogenic structure and volumetric ice content of the ground. First of all geological prospecting must establish the conditions of occurrence of the original massive crystalline rock and its construction engineering properties; whether it occurs as a solid stratum with little fissuring or is it a typical rocky material, ie does it consist of rocks with fissure and block structure or of semi-rock material which is schisty and showing multiple manifestations of cryogenic processes? The latter type of rock material (schisty semi-rock) are encountered very often in permafrost regions. When used as foundations, they represent the greatest dangers to hydroelectric structures, because in the frozen state they appear as extremely strong monolithic rocks, but on thawing they often change into highly compressible rocks, which causes their own settling and subsidence.

The design and construction principles which determine whether the frozen or unfrozen earth material dam will be selected, depend on whether a strong massive crystalline rock, or a weak (on thawing) earth material deposit is present, and also on the degree of stability of the permafrost temperature regime at the construction site. The unfrozen earth dam is used only in the presence of massive crystalline (unfragmented) original rock or unfrozen and thawing rock material of low compressibility. Unfrozen earth dams may be built practically on any type of permafrost provided that the frozen state of the foundation and of the major part of the dam permafrost is maintained. It is the latter that ensures the impermeability of the dam.

The unfrozen earth dam is designed on the assumption that the base will thaw completely. The impermeability of the dam body in long-term operation is ensured by means of an impermeable shield (usually made of densified argillaceous soil), as in the case of the 75 m high fluvial Vilyuysk dam (Fig. 4, a [3]), or by building the core of the dam of water impermeable material, as in the case of the 65 m high fluvial dam of the Khantaysk project (Fig. 4, b [3]).

For the frozen earth dam design the following solutions may be used: first - the use of a stratified profile (with slopes lower than 1:5), where the isotherm of the earth material of the dam body under the crest slope does not reach the average profile of the earth dam at any time (even when the temperature regime has stabilized), and the base slope remains in the frozen state; second - in conjunction with a less stratified profile (with slopes of 1:3, 1:4) a cooling system is used (as in the case of the Ierelyakh dam, for instance, Fig. 4, c [3]) consisting of a pipe structure located in the centre of the profile. Cold air circulates through it in winter, or a refrigerant is driven mechanically (usually CaCl_2), to maintain the constantly required negative temperature. Another type of cooling system is used at the dam of Lake Dolgoe, where self-circulating air cools the base slope in winter. The natural cold air circulation is assisted by a specially constructed covered gallery. The frozen state of the base slope has been maintained in this fashion for the last twenty years.

It should be noted that for the design and construction of earth dams under the permafrost conditions of arctic regions, it is absolutely necessary to forecast, using heat engineering means, the temperature regimes of thaw zone of the permafrost and of lower layers, and to construct isotherms for the bodies of earth dams and their foundations. The isotherms must be prepared for the time period between the beginning of filling of the reservoirs and the operation of the dam, as well as for the limiting steady state of the temperature field of the earth dam and its foundation. Moreover, the earth dam must have the profile and auxiliary installations which will ensure its stability and impermeability throughout its operational life. Particular attention would also be drawn to the necessity of providing high quality workmanship in constructing the structures

joining the earth dam to the reservoir banks and particularly in constructing flood-water discharges. The frozen state of the foundations of the latter may be maintained by periodic application of artificial refrigeration.

Earth dams built on permafrost must absolutely be provided with measuring and regulating devices (KIA) for periodic mensuration and regulation of the dam's state during its operation.

4. Principles of the analysis of earth dams and their foundations for arctic conditions

The distinguishing feature of earth dam design for arctic regions and permafrost foundations is the necessity of carrying out, first and foremost, a series of heat engineering analyses on the basis of the forecast steady state and non-steady state temperature conditions of dams and their foundations, of thawing of banks and bottom of the reservoir, and artificial freezing of earth materials to create a permafrost barrier in the frozen dam and foundation [14 - 17]. Due to the achievements of Soviet scientists, primarily of the scholars working under Prof. P.A. Bogoslovskiy [14, 15], the Corresponding Member of the Academy of Sciences of the USSR, Prof. N.A. Tsytovich, [2, 20] and at the B.E. Vedeneev All Union Institute of Scientific Research in Geology (VNIIG) [16, 17, 18], methods were developed for the temperature analysis of earth dams and reservoirs. Many one- and two-dimensional problems, primarily the simplest, were solved for homogeneous, earth and rock-fill, permeable and impermeable dams using analytical and numerical methods (MKR). Yet many practical problems in forecasting temperature-humidity regimes of non-homogeneous, multi-component, rock-fill dams, and problems in accounting for three-dimensional heat and mass exchange and cryogenic processes in the dam and foundation, remain unresolved to this day. Thus, the question of refining the old and new methods of calculation of thermal regimes of earth dams, particularly of high dams, continues to be acute. In this respect the application of numerical methods including the method of finite elements, which is used extensively abroad and was adapted to temperature analyses of earth dams in the USSR in recent years, to the solution of complex three-dimensional problems of forecasting temperature regimes of dams and foundations is very promising [21, 22].

For unfrozen earth dams the results of temperature analyses determine the type of construction and the parameters for impermeable elements (cores, shields), filters, transition zones, drainage systems, crest and slope ballast loads. For frozen dams the results are used to determine where to locate the water pressure supporting frozen zones, to refine construction details, and to establish the distribution scheme of refrigerating columns and select the refrigerating installations required for maintaining the frozen state of dams and foundations.

The permeability of the impermeable elements is calculated

concurrently with the thermal calculations. Selection of reverse filters is made in relation to the absence of suffosion in the earth material of the core. It is important to note that the methodology of experimental research and calculation of thermal and permeability regimes and the methodology for selecting suffosion resistant filters were developed in the USSR at the B.E. Vedeneev VNIIG for high rock-fill dams constructed with partially frozen core zones. The partial freezing during the construction and subsequent thawing during the operation under pressure [23] were taken into consideration in the development of the methodologies. The problem of forecasting three-dimensional non-steady state temperature regimes, of stratified frozen cores (shields) and the development of permeability in the process of gradual thawing during the exploitation, still remains unresolved.

The most important stage in designing earth dams is the calculation of the stress-strain relationship, strength, and stability during their operation. The methods of such calculations for high unfrozen dams are similar to those used for unfrozen dams in regions of moderate climate. The designing of high rock-fill dams (such as the Kolyma hydroelectric station, for instance) is accompanied by extensive research and detailed calculations of the slope stability of dams and prediction of their stress-strain relationship on the basis of the latest achievements in soil mechanics [20, 21] and with consideration being given to the mutual influence of such factors as the complex stress-strain relationship (NDS), average main pressure, load trajectory, contraction, dilatation, and of other NDS parameters and properties. These parameters require individual and special consideration in the case of high dams (above 80-100 m) and particularly for extremely high earth dams (above 150-200 m). It should be noted at the same time that such detailed complex calculations are not carried out for permafrost dams; the main calculations of slope stability are made using the simplest familiar method (of the type of cylindrical slippage surfaces, etc) of soil mechanics, but, permafrost properties (creep, variability of strength and strain characteristics, etc) are not given sufficient consideration. Furthermore, the complex non-steady state temperature condition of earth materials, which essentially predetermines the stress-strain relationship and the reliability of the entire dam, is given very little consideration in the soil mechanics calculations for earth dams in arctic regions.

In this respect the application of the theory of thermal elasticity of thermal rheology [21] to dam calculations, and of the theory of thermal mechanics of the solid state and structural thermal mechanics to complex and composite mechanical and thermodynamics problems involving concurrent influences of mechanical, thermal, and material exchange processes (including cryogenic) [10] is fully justified and extremely promising. Development of such applications to northern water engineering and engineering geocryology has begun in the USSR during the most recent years [21, 25 and others].

Another important achievement of Soviet scientists is the establishment of the basic types of development of cryogenic processes in earth dams and foundations and of the principles governing such developments. This achievement was the result of complex analytical, experimental and, above all, full-scale investigations carried out over many years for the first high rock-fill dams built in the North at the Vilyuysk and Ust'-Khan-taysk hydroelectric stations [3, 10, 20, 23, 26, 27, 28], where forecasting and control methods were developed to increase the operational life of dams under the severe climatic and complex engineering-geocryologic conditions of arctic regions. It should be mentioned that until about ten years ago cryogenic processes in earth dams were not considered nor researched sufficiently. This accounts for the short life of many small low pressure-head dams [26]. Crest structures and improvement measures, to prevent dangers from cryogenic processes and occurrence of straining, were developed during the design and construction of the first high dams of the Vilyuysk and Ust'Khantaysk hydroelectric stations on the basis of special research carried out at MISI under the general leadership of N.A. Tsytovich, Corresponding Member of the Academy of Sciences of the USSR [3, 28, 30]. Experience gained during the eight to ten years of operation of these dams proved the effectiveness of the anti-cryogenic measures recommended by MISI (including anti-heaving salting of soils in potential freezing zones, heating and ballast loading of the crest, use of soil mixtures with low heaving characteristics, etc.) [3, 25, 27]. This allows us to recommend their wider application to arctic earth dam construction here and abroad.

One of the most important questions, ie the development of long-term forecasting of the behaviour of dams, which takes into consideration cryogenic processes, and estimation of the influence of cryogenic processes on the physico-mechanical properties of soil materials of dams, stability of slopes, and longevity of dams, continues to be a neglected problem which needs further studying and resolving. It is particularly important to point out the necessity of taking into consideration potential ice formation in the support rock-fills of dams during the design and forecasting of their behaviour in operation. Failing this the stress-strain and stability analysis of earthfill dams will not be sufficiently accurate or reliable.

The use of MISI criteria, which have been tested sufficiently in arctic dam construction of the past ten years [13], is recommended when estimating the frost-susceptibility of earth materials used for dams.

To refine the analysis of earthfill dams, work must be carried out on methods for rigorous accounting of temperature-moisture and permeability regimes and of cryogenic processes in the dam on the basis of natural observations of earth dams in operation, concurrently with a wider application of numerical methods and computers. Practically any complex theoretical or practical problem of northern water engineering and engineering geocryology may be resolved using numerical methods and computers.

5. Special Features of the Organization of Construction Work and Construction Technology of Earthfill Dams

5.1. Special Features of the organization of construction work

The regions under consideration for construction are usually characterized by a severe climate, negative average yearly temperatures, as low as -12°C , seasonal temperature variations as high as 100°C , and by the presence of permafrost almost everywhere. The hydrological regime is extremely irregular. The main volume of discharge takes place during the spring-summer period, while winter discharge is practically absent in the case of most small and medium size rivers. Often, rivers freeze to the bottom.

Such factors as extremely complex natural conditions, low salinity, great distances to populated and industrialized regions of the country, and low concentration of roads and railways complicate the organization of construction in arctic regions. Given the low density of roads and railways, transportation must use natural navigational routes, which have primarily meridional directions, and winter roads. Their economic significance is, however, diminished by their seasonal operation, since the latter lengthens the time shipments spent in transport. This may be illustrated by the transportation route used for the Vilyuysk hydroelectric station [1, 29]. Shipments destined for this construction site were transported by railway to the Osetrovo harbour, from here by Lena river to Lensk city (990 km), by truck to Mirniy city (235 km), and by winter road (110 km) to the construction site.

Such a complex line of transportation, which, moreover, is seasonal, and irregularity of delivery of materials make it necessary to have storage buildings at load transfer points and to store construction supplies at the construction site for almost a year. Under such conditions significant losses of supplies in transport and at the numerous transfer points, and deterioration in quality during long-term storage, are unavoidable. All this contributes significantly towards higher costs of construction.

The factors described above make it necessary to maximize the utilization of local earth construction materials and to minimize utilization of materials brought from distant locations.

5.2. Special features of the construction technology of earthfill dams

The specific natural and climatic conditions of arctic regions complicate significantly the carrying out of construction work. In order to reduce total construction time it is necessary to lengthen the construction season by working in winter at low outdoor temperatures. Problems of winter construction have basically been resolved in the USSR, and practically all construction work is carried out around the year. Water engineering construction involves operations with huge volumes of soil and

rock. Carrying out such operations in winter is associated with certain difficulties. Greatest difficulties are encountered in the erection of embankments of good quality made of cohesive soil and also in carrying out preparatory work for foundations of dams.

5.2.1. Certain special features of the technology of erecting frozen earthfill dams

Construction of frozen earthfill dams consists of the following types of activity, which follow in a certain sequence: preparation of the foundation; cutting of the trench and filling of cut-off walls with loam; construction of the sections adjacent to banks, while keeping open the gap in the fluvial section for highwater flow; assembly of the refrigerating system and creation of the frozen partial cut-off in the bank sections of the dam prior to plugging the fluvial gap; plugging the gap and building up of the dam in the fluvial section and the subsequent freezing of the subfluvial talik and the loam core of this most important part of the dam.

Experience shows that it is quite expedient to carry out the build up of supporting fills in winter. In this way it is possible to begin with lower temperature levels in the body of the dam.

The technology and methods of construction of frozen dams are improving constantly. The dam on the Sytykan river, for instance, was built in two stages, the first of which was essentially as described above. It is of interest that a daring decision was taken during the planning of this project, ie to let the spring high-water run over the crest of the unfinished dam during the second stage. In fact two high-water flows were allowed to run over the crest of the dam. One of them carried twice the calculated volume of water.

The refrigerating columns were installed in the core of the dam on completion of the first stage; they were extended as the dam was gradually built up to the design height. Experience has shown that it is more expedient, in the technical and economical sense, to mount the refrigerating system in advance. Such a method ensures a high reliability of the frozen partial cut-off, which is frozen as the dam grows in height, and allows changes to be made in the structure of the dam.

It is no longer necessary, for instance, to construct the cut-off wall, since permeation through the foundation of the dam is now eliminated. Any type of earth material can now be used including lumpy frozen soil providing the pores are filled with water or soil grouts.

The technological peculiarities of the construction of unfrozen dams are related mainly to foundation preparation and laying of cohesive soils in temperatures below the freezing point. The technology for laying cohesive soils in winter is

now developed in the Soviet Union [29].

5.2.2. The technology of winter laying of cohesive soils

Much time has been devoted in the practice of water engineering construction to research on methods of winter construction of high quality embankments of earth materials under conditions of low air temperatures. The problem becomes particularly difficult if the construction is carried out under the severe climatic condition of arctic regions. The entire sequence of technological processes becomes complicated, i.e. the following processes: organization of operations in quarries where permafrost is present and layers of quarry materials are thin, delivery of materials taking care to minimize its temperature drop, ensuring that workmanship in laying material is good, compacting the material to establish the necessary contact between the various layers in order to produce homogeneous embankments despite the fast freezing of the soil.

Soviet scientists and engineers have developed methods for lowering the freezing point of soils by means of adding salt, and have introduced these methods into practice [20, 28, 30]. At air temperatures of -30°C to -40°C salt treatment of the soil alone is not sufficient. It is necessary to employ other methods concurrently intended to minimize heat losses throughout the sequence of technological operations, to maintain the positive temperature of the soil until the completion of its compacting. Moreover, it is difficult to prevent freezing of the laid stratum of soil before it is covered by the subsequent layer, if the work is carried out in the open (without the use of winter shelters), regardless of the kind of additional methods employed. Thus, the subsequent layer is laid on a frozen layer.

The chemical anti-freezing of soil must, therefore, be accompanied by other measures taken to maintain the unfrozen state of the soil and high positive temperatures while preparing the site, processing the soil, delivering it to the site and compacting it to provide good contact between the various layers.

In recent years a complex technological method for laying cohesive soils under extremely low negative temperatures [29] has been developed in our country and introduced successfully into practice. This method consists of the following operations which take place starting at the quarry and ending at the structure:

- organization of quarry operations and stock-piling of earth materials;
- winter storing of soils in piles;
- anti-freezing of the soil stored in piles by means of salting;
- electric heating of piles for winter storing of soil;

- constructing the soil piles for winter storage;
- transportation of the soil to the construction site;
- preparation of the site prior to the laying of soil;
- heating and salting of the preceding layer;
- soil delivery to the site and covering it to prevent premature cooling;
- levelling of the soil;
- salting of the layer's surface by means of a salt solution;
- compacting the soil.

If all the elements of this technological chain of processes is carried out as prescribed, the unfrozen state of the soil will be maintained to the completion of the compacting, the contact between the various layers of the embankment will be tight, and the quality of the structure will be good.

5.2.3. Certain peculiarities of stock-piling of earth materials in quarries

Such factors as the occurrence of permafrost in quarries and frequently encountered thin layers of useful earth material, which is characteristic of eluvial-deluvial deposits, a grain size composition and moisture content which vary widely with the depth of occurrence, shortness of the summer season, and operations involving movement of large volumes of earth determine the peculiarities of quarry operations and associated technology. An economical large scale extraction and stockpiling of cohesive earth materials is practical only in summer, as the thawing progresses.

The work of opening up a quarry begins with the clearing of snow and felling of trees. This work is usually done by bulldozers at the beginning of spring. This is the time when frozen trees are easily undercut beneath the roots and cleared away with the brush and snow. The surface of the quarry, freed of snow and vegetation, begins to warm up well before the complete disappearance of the snow cover. The sun's total radiation in spring (April-May) is extremely high in permafrost regions. Timely removal of the snow cover allows full utilization of the radiation energy for warming up the top soil instead of wasting it on melting the snow and evaporating the snow water.

Cutting of the top soil can begin when the thawing has reached a depth not exceeding 10-15 cm. Further development of the quarry and stockpiling of the loam is carried out using bulldozers, as the thawing progresses. The thawing rate usually reaches values of 10-15 cm/day. The collected soil is kept in

heaps for 2-3 weeks. During this time its temperature increases significantly, while the moisture content decreases. The soil is then transported to locations where it can be piled for winter storage, or to the construction site in case the embankment is to be built during the summer [1, 29].

The usual means of soil protection against winter freezing in quarries using natural and artificial heat insulation covers are ineffective under severe climatic conditions, if the permafrost layer is thick and the loam stratum is thin.

Therefore, the use of steam or electric heating or chemical methods in quarry operations in winter are extremely expensive and, thus, quite ineffective.

Since quarry operations in winter are uneconomical and practically impossible, unfrozen earth material must be stockpiled in summer and kept in piles for several months until they are needed for winter laying.

Research carried out during the construction of the Vilyuysk hydroelectric station shows that in winter the temperature of soil materials decreases by 6 to 10°C during their treatment, transportation, laying and compacting, depending on a number of factors. Therefore, in order to ensure that the soil has a minimum temperature of 2 to 3°C when it is layed at the construction site, its temperature in the storage pile may not be under 10 to 13°C. This temperature can be maintained in large volumes of soil. Piles accommodating 250,000 m³ of loam with heights of 16-18 m and specific surfaces of 0.12 to 0.13 m²/m³ have been made.

Cohesive soils, however, freeze even in winter storage piles. To prevent this, additional passive, active and chemical measures must be taken to reduce the depth of freezing. The most rational way of protecting the soil from freezing is by combining passive, active and chemical methods. Such measures are:

- salting the soil at the peripheral zones of the piles;
- electric heating of the peripheral zones of the piles, and
- heat insulation of piles by covering their surfaces with ice foam.

At the peripheral zones of piles a soil layer of 2-2.5 m is poured with an admixture of salt on the basis of 20-30 km/m².

One of the passive methods of protecting soil from freezing is the method of covering the slopes of piles with ice foam. The effectiveness of the ice foam method depends on the proper selection of the starting time of the operation and preliminary heating of the air fed into the fixer. This improves the foam formation and increases the stability and expansion ratio of the

foam[29].

5.3. Construction peculiarities of discharge arrangements

Analysis of the accumulated construction experience indicates that the erection of the two main structures of a hydroelectric station, ie the dam and the discharge arrangements, are often based on different temperature principles without proper justification. Individual specialists express the opinion that it is not necessary to erect all the structures of a hydroelectric station on the basis of the same temperature principle. In our opinion this is not so.

Discharge arrangements are usually located at one of the bank slopes and adjoin the dam. Under such conditions a mutual influence of the temperature fields and the beginning of a heat exchange process is inevitable. Moreover, the heat and mass exchange in the body and foundation of discharge arrangements may be much more intensive than in the dam itself. For this reason in construction on permafrost particular attention must be devoted to the temperature regime of discharge arrangements and to the forecasting of its dynamics. As a rule, all the structures of a hydroelectric station should be based on the same temperature principle.

5.4. Discharge rates during construction

The scheme for discharge rates during construction depends on the hydrological regime of the river, geological and topographic conditions of the construction site, and on the general scheme of erection of structures and duration of the construction project. Concurrently, organization of the construction work and the associated technology are determined by the hydrological regime of the river and the accepted scheme for discharge rates during construction. It is most expedient to discharge high water along the main river bed or through the gap in the dam (possibly with a concurrent flow over the crest of uncompleted dams). On the other hand summer low water and winter discharges are passed through discharge arrangements (tunnels, channels, chutes, pipes). Moreover, the discharged practice may change depending on the erection stage of the structure. For instance, during the first stage the discharge may be through the fluvial gap, while in the second stage it may be through the channel, pipes, etc.

It was already mentioned that the hydrological regimes of rivers in permafrost regions are peculiar. Up to 85-90% of the total yearly discharge flows during the spring high water; the summer-autumn period is characterized by low discharge rates and fluvial high water, while in winter discharge rates are lowest. In periods of low river flow rates dams may be raised to a point where water accumulates to a level above the cofferdams of construction pits. Another favourable factor may be the topography of the future water reservoir which may take

in the river discharge allowing construction of the fluvial part of the dam at low levels, or delaying the rise of the water level to permit other smaller construction operations to be carried out within a short period of time. Diverting the river along bypass channels or through tunnels is the most convenient method for construction work. In this manner construction may be carried out concurrently at all sites, which simplifies significantly the structure erecting technology. Although, on non-rocky permafrost this method is not always applicable (particularly in construction of frozen dams) where thawing of foundation ground is required.

When calculating summer discharge rates, it is necessary to take into consideration the possibility of fluvial high water peaks coinciding with the so-called "black water" which is the result of intensive thawing of permafrost.

In conclusion it should be noted that to date a certain amount of experience has been accumulated in our country and abroad on successful designing, construction and operation of earth dams under the severe climatic conditions of arctic regions and on permafrost foundations. The accumulated experience requires an in depth and comprehensive analysis and generalization. Experience indicates [3] that frozen and unfrozen earthfill dams are fully reliable water engineering structures, providing the project has been well substantiated and prepared, high quality of construction workmanship was maintained, and their operation placed in well qualified hands.

BIBLIOGRAPHY

1. Biyanov, G.F. Dams on permafrost. Energiya, Moscow, 1975, p. 184
2. Tsytoovich, N.A., Ukhova, N.V., Ukhov, S.B. Forecasting the thermal stability of dams constructed of local materials on permafrost foundations. Stroizdat, Leningrad, 1972, p. 140
3. Kronik, Ya.A. Water engineering construction in the northern part of the Siberian platform. Engineering geology in the USSR. Edited by E.M. Sergeev. Vol. 3, Eastern Siberia. Izdatel'stvo MGU, 1977, pp. 260-270
4. Karpyshev, E.S., Molokov, L.I. et al. Engineering-geological research on construction of water engineering structures. Edited by E.S. Karpyshev. Energiya, Moscow, 1972, p. 376
5. The methodology of complex permafrost-hydrogeological and engineering-geological surveying, scales of 1:200,000 and 1:500,000. Edited by V.A. Kudryavtsev, K.A. Kondrat'eva and N.I. Trush. Izdatel'stvo MGU, Moscow, 1970, p. 354
6. Kagan, A.A., Krivonogova, N.F. Permafrost rock foundations of structures. L. Stroizdat, L.O. 1978, p. 208

7. The Kenney rock-fill dam. Construction methods and equipment. 1952, Vol. 34, No. 10, pp. 50-54
8. Johnston, G.H. Dykes on permafrost, Kelsey generation station. Manitoba. Canadian Geotechn. J. 1969, Vol. 6, No. 2, pp. 139-157
9. Biyanov, G.E. Construction of dams in the Canadian North. Gidrotekhnicheskoe stroitel'stvo, 1970, No. 1, pp. 48-54
10. Kronik, Ya.A. Cryogenic processes in earthfill structures and foundations, 1970, No. 1, pp. 41-48
11. Tomirdiario, S.V. Permafrost and opening of mountainous regions and lowlands. Magadanskoe knizhnoe izdatel'stvo, 1972, p. 176
12. Tsytovich, N.A., Kronik, Ya.A. Physical and mechanical properties of frozen and thawing coarse grained soils. Proceedings of the II International Conference on Permafrost. 4th edition, Yakutskoe Knizhnoe Isdatel'stvo, Yakutsk, 1973, pp. 52-62
13. Tsytovich, N.A., Kronik, Ya.A. Physico-mechanical and physico-chemical properties of some cohesive soils for earth-and-rock-fill dam construction in the North. Proceedings of the I International Conference on Engineering Geology, Paris, 1970, pp. 2-12
14. Bogoslovskii, P.A., Stotsenko, A.V., Veselov, V.A., Ukhov, S.B., Tsvid, A.A. Dams in permafrost regions. Proceedings of the International Conference on Permafrost, The Publishing House of the Academy of Sciences of the USSR, 1963, pp. 167-179
15. Recommendations for the design and construction of earthfill dams for industrial and potable water supply in arctic regions and on permafrost. VNIIVODGEO (All-Union Scientific Research Institute of Water Supply, Sewer Systems, Hydraulic Engineering Structures and Engineering Hydrogeology), Moscow, Stroizdat, 1976, p. 112
16. Instructions for the design and construction of towns, enterprises, buildings and structures in northern climatic zones. SN 353-66, Moscow, Stroizdat, 1967, p. 100
17. Instructions for thermal analysis of water reservoirs. VSN 46-71. VNIIG (All-Union Scientific Research Institute of Hydraulic Engineering), Energiya, Leningrad Order of Lenin (State University), 1972, p. 72
18. Mukhtedinov, N.A. Thermal regime of downstream fills of rockfill dams. Izvestiya VNIIG, 1969, Vol. 90, pp. 275-294

19. Frid, S.A., Levenikh, D.P. Effect of temperature variations on water engineering structures under northern climatic conditions. Leningrad, Stroiizdat, L.O. 1978, p. 194
20. Tsytoovich, N.A. The mechanics of frozen ground. Moscow, Vysshaya Shkola, 1973, p. 446
21. Kronik, Ya.A. Application of the theory of thermal elasticity to problems of engineering geocryology. Methodology of engineering-geological research and mapping of permafrost, 2nd edition, Yakutskoe Knizhnoe izdatel'stvo, Yakutsk, 1977, pp. 42-44
22. Kronik, Ya.A., Demin, I.I. Analysis of the temperature regime of dams constructed using local materials and the method of finite elements. Water engineering construction, 1978, No. 12, pp. 12-17
23. Kuperman, V.L., Myznikov, Yu.N., Plotnikov, V.M. The Ust'-Khantaysk dams. Moscow, Energiya, 1977, p. 152
24. Tsytoovich, N.A. Soil mechanics. 2nd edition, Vysshaya Shkola, Moscow, 1973, p. 280
25. Kronik, Ya.A. Certain basic engineering-geocryological problems encountered in the construction of power projects in permafrost regions. 4th issue. Proceedings of the scientific seminar of 1-5 June 1977. Yakutsk. Yakutskoe Knizhnoe izdatel'stvo, 1978 pp. 41-55
26. Kamenskii, R.M. et al. Design of dams for irrigation and land reclamation projects in Central Yakutiya. Yakutskoe knizhnoe izdatel'stvo. Yakutsk, 1976, p. 236
27. Kronik, Ya.A., Kadkina, E.L., Loseva, S.G. Analysis of the state of the core of the fluvial dam of the Ust'-Khantaysk hydroelectric station. Water engineering construction, 1978, No. 6, pp. 12-18
28. Tsytoovich, N.A., Ukhov, S.B., Kronik, Ya.A. Integrated measures of the physicochemical method of combatting frost heave in embankments. Danube-European Conference. Soil mechanics in highway construction. Vienna, 8-10 May 1968, Proceedings.
29. Batenchuk, E.N., Biyanov, G.F. et al. Winter laying of cohesive soils in arctic regions. Energiya, Moscow, 1968, p. 120
30. Kronik, Ya.A. Anti-heave salting of loams during the winter construction of the apron of the Vilyuysk dam. Express-information of OES (All-Union Institute for the Planning of Electric Power Projects), The series: Construction of hydroelectric stations, 1968, No. 8, pp. 1-12

Captions of Illustrations

- Fig. 1. A longitudinal and geological section along the axis of the right-bank dam of the Ust'-Khantaysk hydroelectric station and its foundation.
1 - lacustrine and boggy deposits: peat, sandy loam, grey loam; 2 - lacustrine deposits: silty loam; 3 - glaciolacustrine deposits: sandy loam, dark grey loam with sand intercalations, varved clay; 4 - glacial deposits: brown loam with inclusions of gravel and rock debris; 5 - bedrock; dolerites, limestones; 6 - borders of permafrost islands.
- Fig. 2. Transverse section of the right-bank dam of the Ust'-Khantaysk hydroelectric station.
1 - gravel and pebbly soil; 2 - sand-gravel mixture; 3 - rocky talus of dolerite (zone of consolidation); 4 - 10-80 mm fraction of sorted gravel; 5 - sand; 6 - rocky talus of limestones; 7 - glacial deposits; 8 - bedrock.
- Fig. 3. Longitudinal section along the axis of the Irelyakh dam and its foundation.
1 - topsoil; 2 - natural surface of the ground; 3 - boundaries of maximum seasonal thaw; 4 - peat depression; 5 - silt depression; 6 - silty loam, 60% ice content; 7 - loam with gravel and bedrock debris, 20-60% ice content; 8 - compact clay (bedrock); 9 - outline of the construction pit under the cut-off wall; 10 - fissured dolomites; 11 - fissured marls; 12 - flaggy limestone; 13 - old river bed filled with pebbles and gravel; 14 - discharge channel; 15 - crest of the dam; 16 - sub-fluvial talik; 17 - better defined boundary of the sub-fluvial talik; 18 - clearing of alluvial deposits in the river bed; 19 - boundary of the fluvial talik as defined in the design; 20 - frozen partial cut-off of the bank of the discharge channel.
- Fig. 4. Transverse sections and the temperature state of earth dams in the arctic regions: a and b - unfrozen rockfill dams with apron (Vilyuysk) and with core (Ust'-Khantaysk), fluvial; c and d - frozen earth dam with dual-pipe air cooling located in centre of core (Irelyakh), and air cooling using a gallery on the side of the low slope (on the Dolgoe Lake).
+ - 1 - unfrozen earth zone;
- - 2 - permafrost zone;
± - 3 - zone of seasonal freezing and thawing: